

US00D494745S1

(12) **United States Design Patent** (10) **Patent No.:** **US D494,745 S**
Kronenberger (45) **Date of Patent:** **** Aug. 24, 2004**

(54) **HEADWEAR PIECE**

(76) **Inventor:** **Ronald Kronenberger**, 320 Portwine Rd., Riverwoods, IL (US) 60015

(**) **Term:** **14 Years**

(21) **Appl. No.:** **29/154,874**

(22) **Filed:** **Jan. 30, 2002**

(51) **LOC (7) Cl.** **02-03**

(52) **U.S. Cl.** **D2/882**

(58) **Field of Search** D2/865, 866, 869, D2/871, 872, 876, 877, 879, 882, 884, 891, 893, 895; 2/171, 181, 195.1, 209.11, 209.12, 209.13; D5/63, 64; D20/12, 22, 28; 40/329

(56) **References Cited**

U.S. PATENT DOCUMENTS

145,391	A	*	12/1873	Bracher	40/329
D132,245	S	*	5/1942	Chase	D5/64
D134,174	S	*	10/1942	Keil	D5/64
4,776,043	A	*	10/1988	Coleman	2/209.12
4,873,726	A	*	10/1989	Tapia	2/195.1
D311,266	S	*	10/1990	Parker	D2/866
5,070,545	A	*	12/1991	Tapia	40/329
5,253,368	A	*	10/1993	Blake	29/154.874
D346,828	S	*	5/1994	Hagen	D20/22
5,359,733	A	*	11/1994	Brannon et al.	2/195.1
5,359,734	A	*	11/1994	Rathburn	2/195.1
D365,916	S	*	1/1996	Hutchinson et al.	D2/866
5,548,847	A	*	8/1996	Spicijaric	2/209.13
5,740,557	A	*	4/1998	Reid et al.	2/209.13
D405,116	S	*	2/1999	Anderson, II	D20/22
5,901,370	A	*	5/1999	Linday	2/10
5,943,702	A	*	8/1999	Kronenberger	2/171.1
D417,063	S	*	11/1999	Henning	D2/866

6,154,992	A	*	12/2000	Lee	40/329
6,175,963	B1	*	1/2001	Loeffelholz	2/209.13
6,240,568	B1	*	6/2001	Lee	2/209.13
6,272,689	B1	*	8/2001	Kronenberger	2/175.1
D453,261	S	*	2/2002	Pisarevsky	D2/882
6,370,696	B1	*	4/2002	Kronenberger	2/175.1
D474,000	S	*	5/2003	O'Dell et al.	D2/882

* cited by examiner

Primary Examiner—Stacia Cadmus

Assistant Examiner—Mimosa De

(74) *Attorney, Agent, or Firm*—Wood, Phillips, Katz, Clark & Mortimer

(57) **CLAIM**

The ornamental design for headwear piece, as shown and described. The elements on the headwear piece shown in broken lines form no part of the claimed design.

DESCRIPTION

FIG. 1 is a front, top and side perspective view of my design for ornamentation on a headwear piece, according to the present invention;

FIG. 2 is a front elevation view thereof;

FIG. 3 is a reduced top plan view thereof;

FIG. 4 is an elevation view thereof from the same side as in FIG. 1;

FIG. 5 is a perspective view of a second embodiment of my design for a headwear piece, according to the present invention;

FIG. 6 is a reduced front elevation view thereof;

FIG. 7 is a reduced top plan view thereof;

FIG. 8 is a reduced side elevation view thereof.

The portions of the headwear piece shown in dotted lines do not constitute a part of the claimed design.

1 Claim, 4 Drawing Sheets

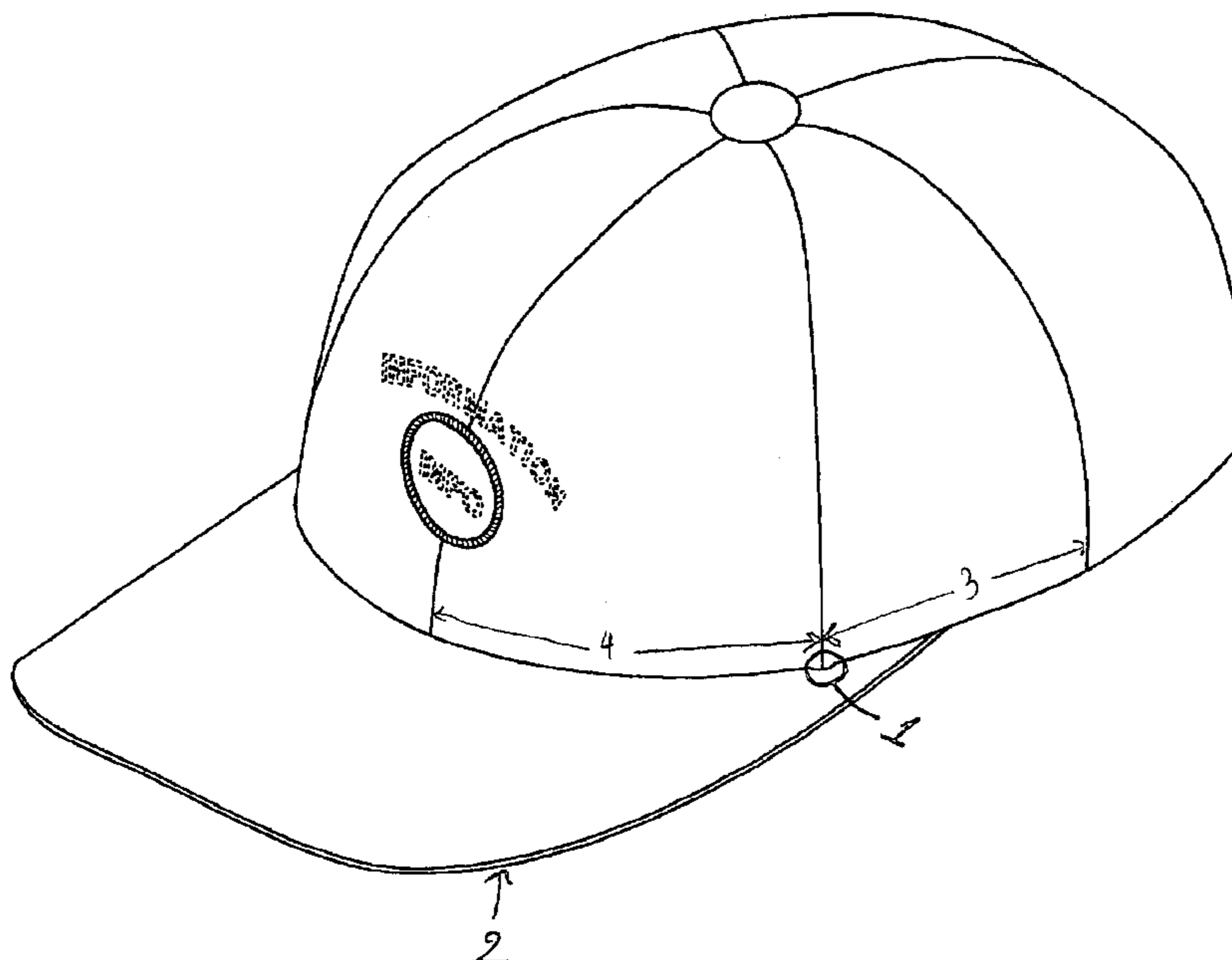

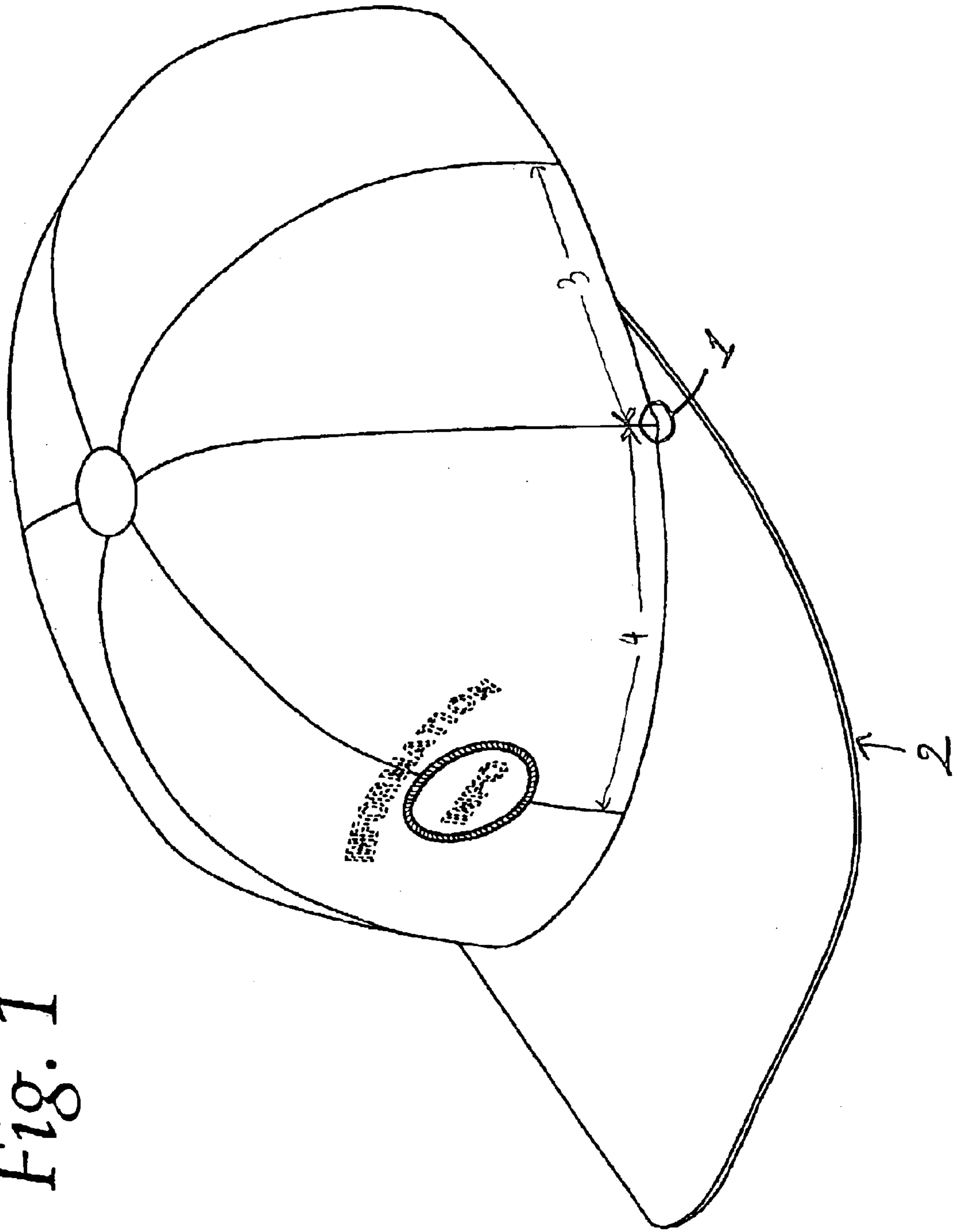

Fig. 1

Fig. 2

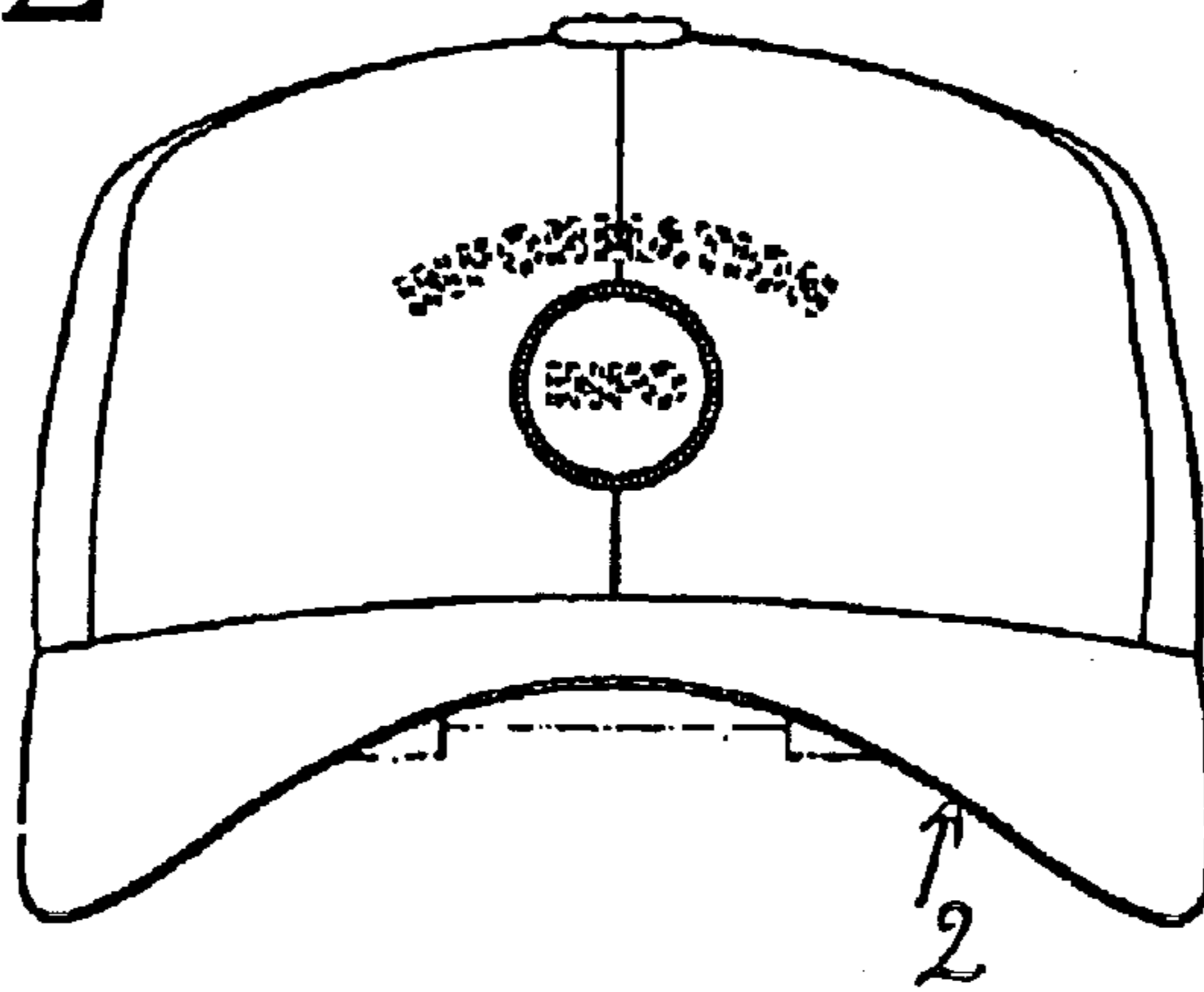

Fig. 3

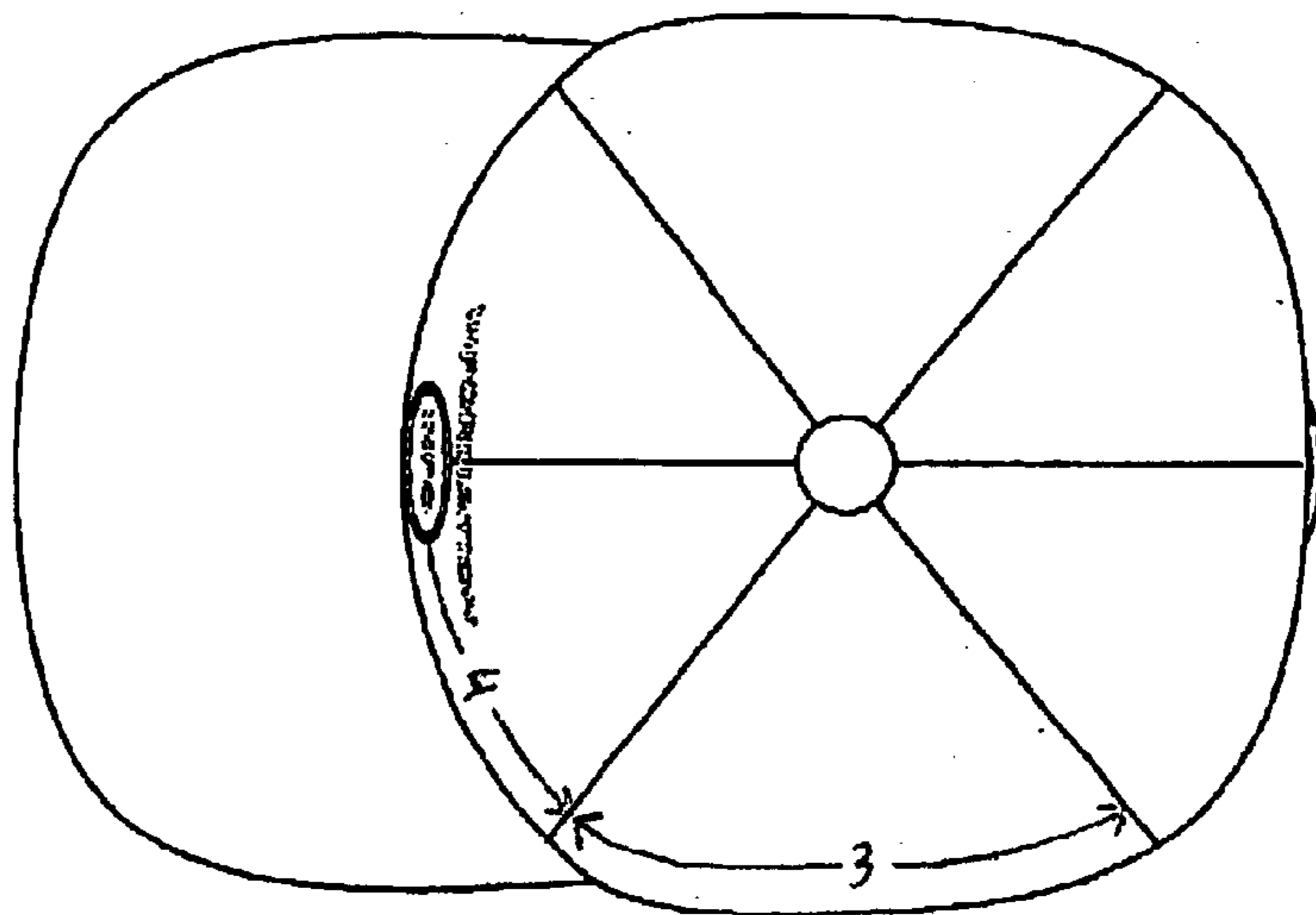
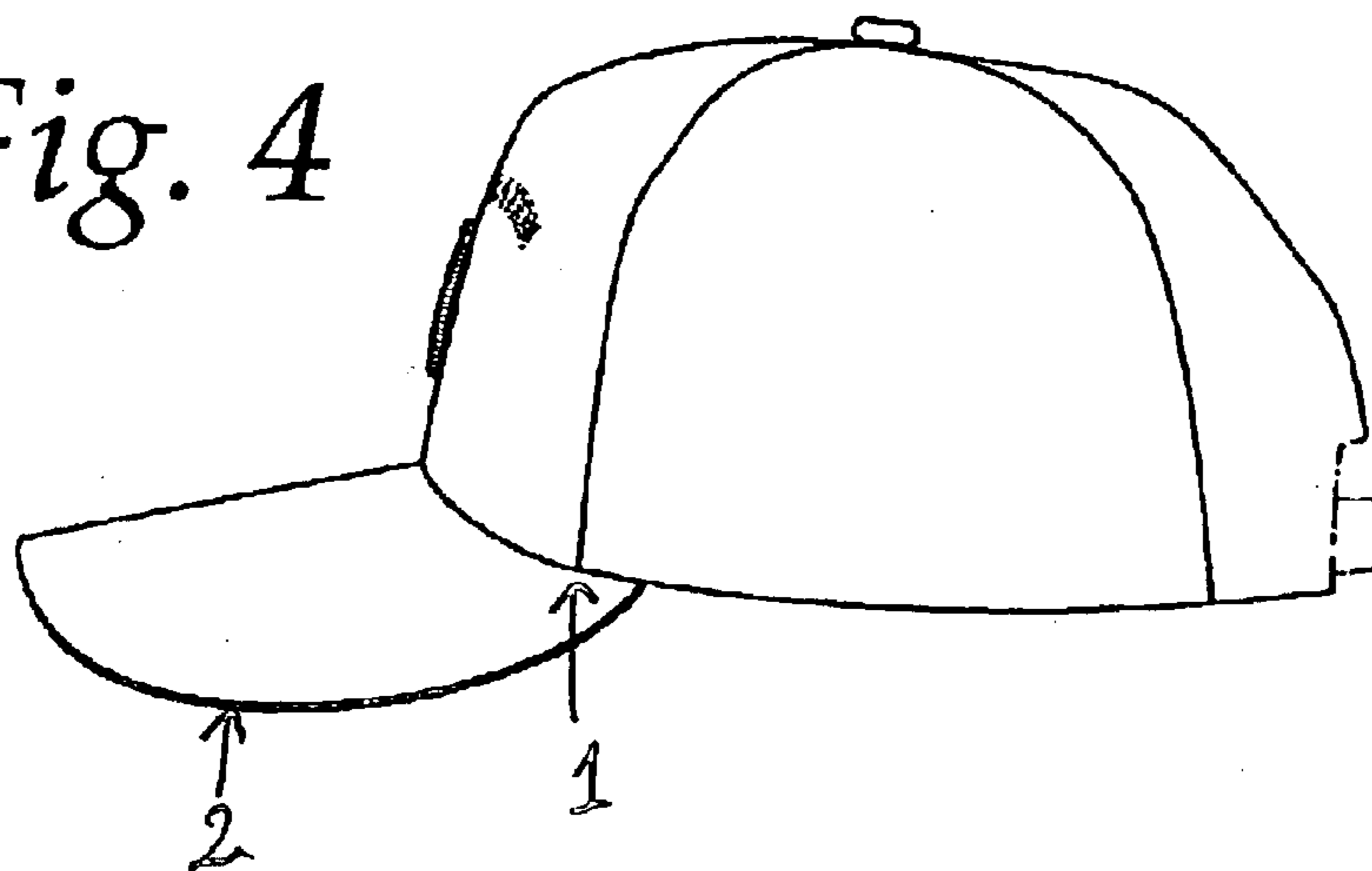

Fig. 4



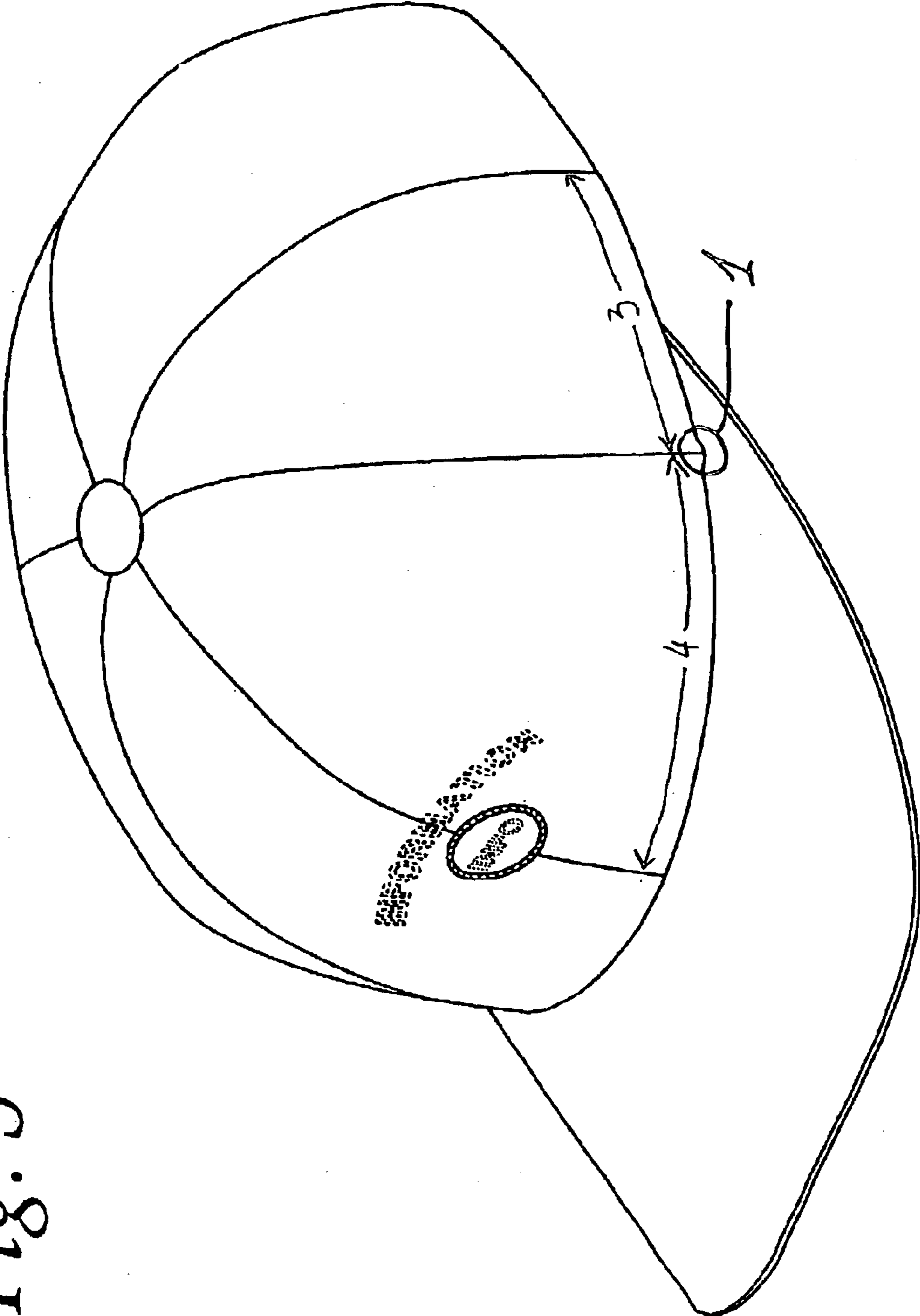

Fig. 5

Fig. 6

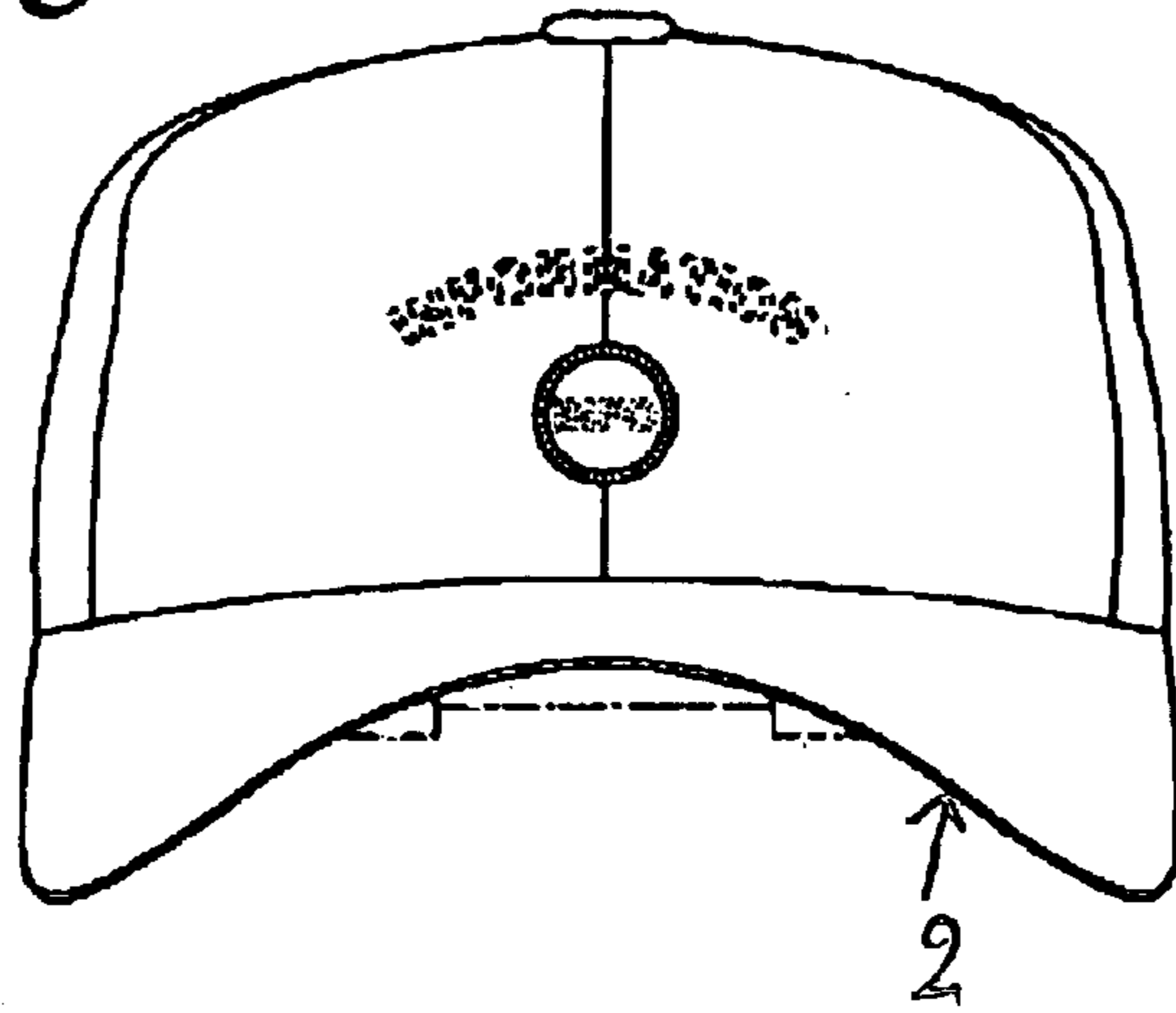

Fig. 7

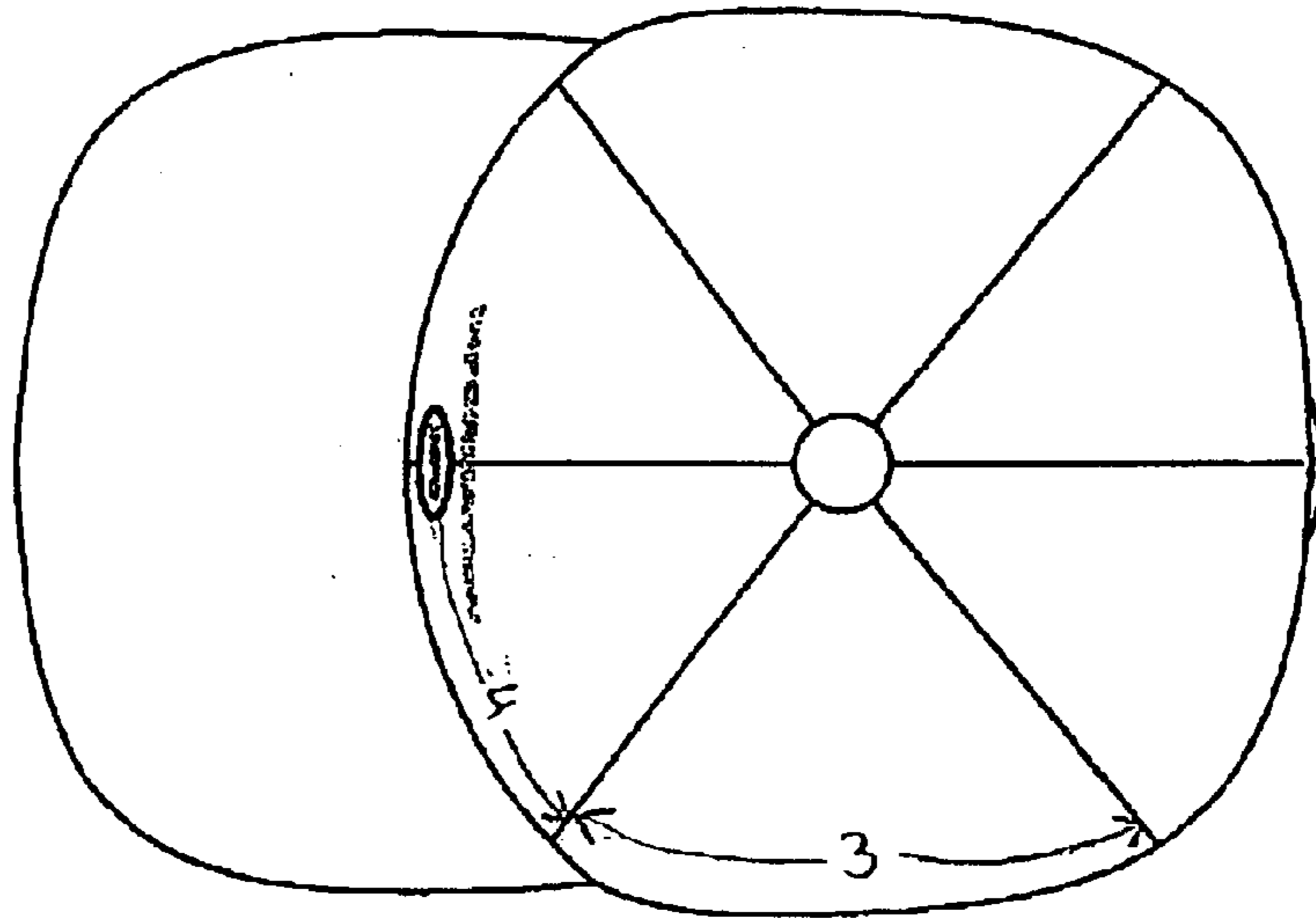
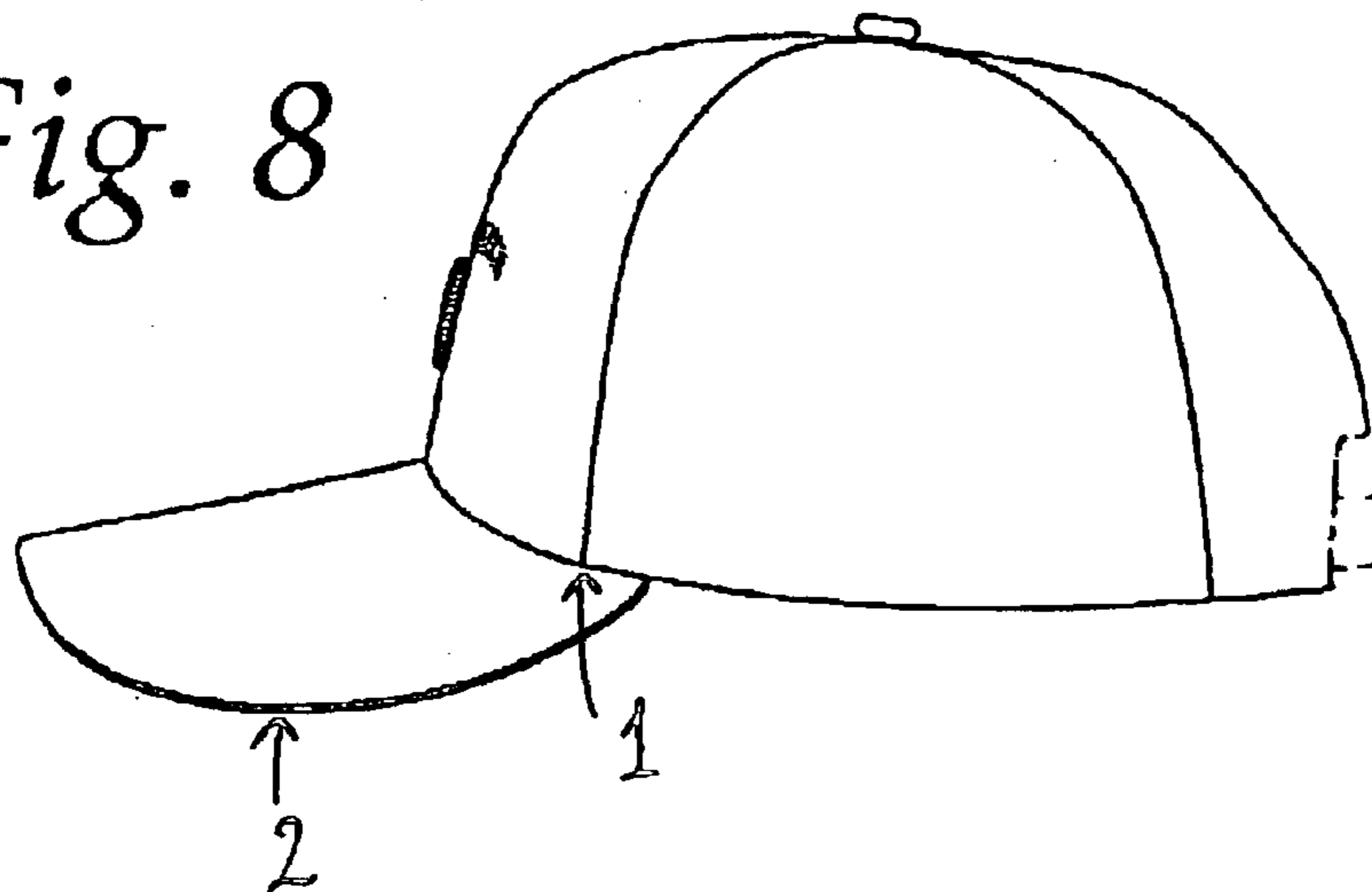

Fig. 8



UNITED STATES PATENT AND TRADEMARK OFFICE
CERTIFICATE OF CORRECTION

PATENT NO. : Des. 494,745 S
DATED : August 24, 2004
INVENTOR(S) : Kronenberger, Ronald

Page 1 of 5

It is certified that error appears in the above-identified patent and that said Letters Patent is hereby corrected as shown below:

Drawings,
Replace FIGS. 1-8 with the formal drawings submitted herewith.

Signed and Sealed this

Fourteenth Day of February, 2006

A handwritten signature in black ink on a light gray dotted background. The signature reads "Jon W. Dudas" in a cursive style.

JON W. DUDAS

Director of the United States Patent and Trademark Office

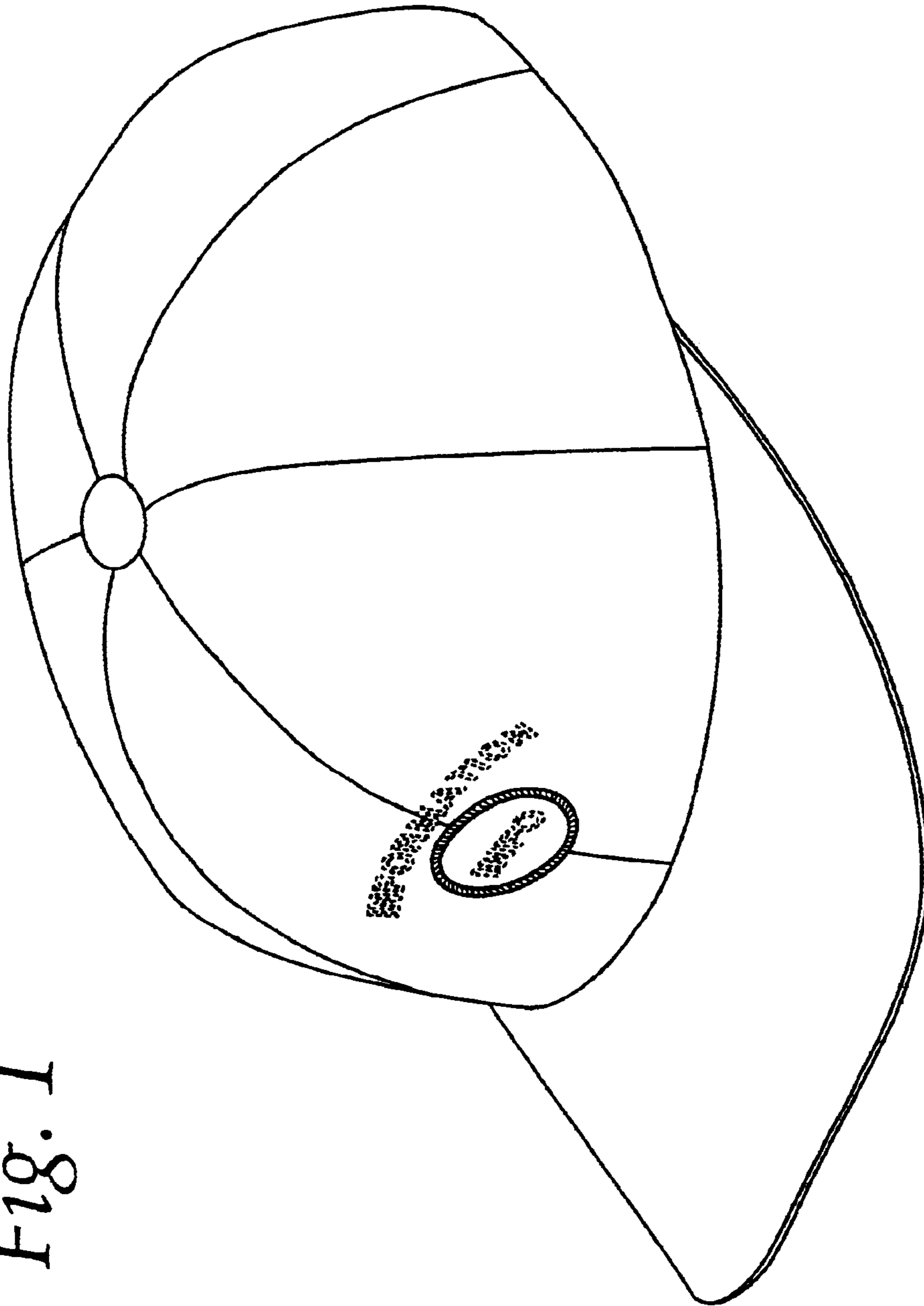

Fig. 1

Fig. 2

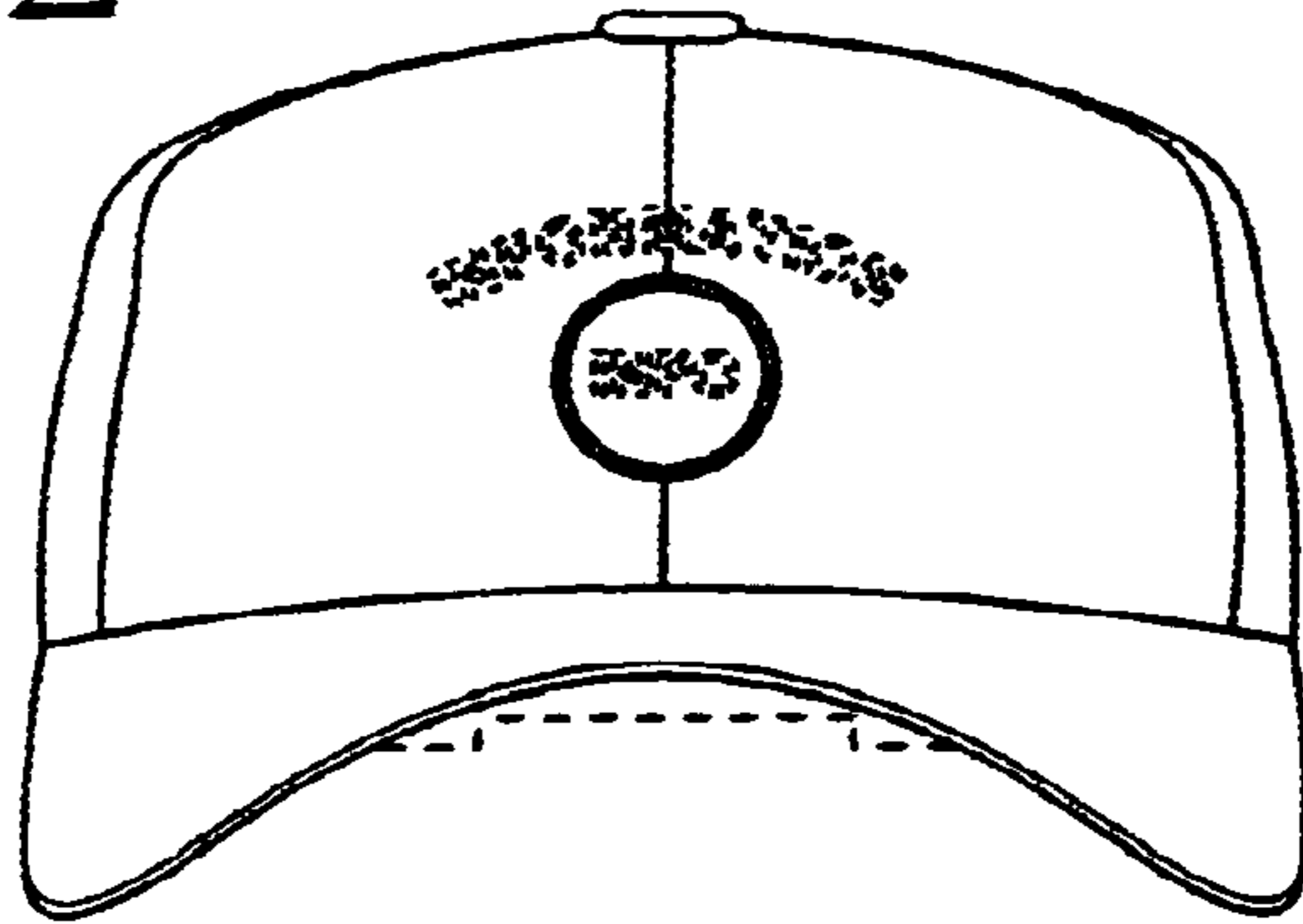

Fig. 3

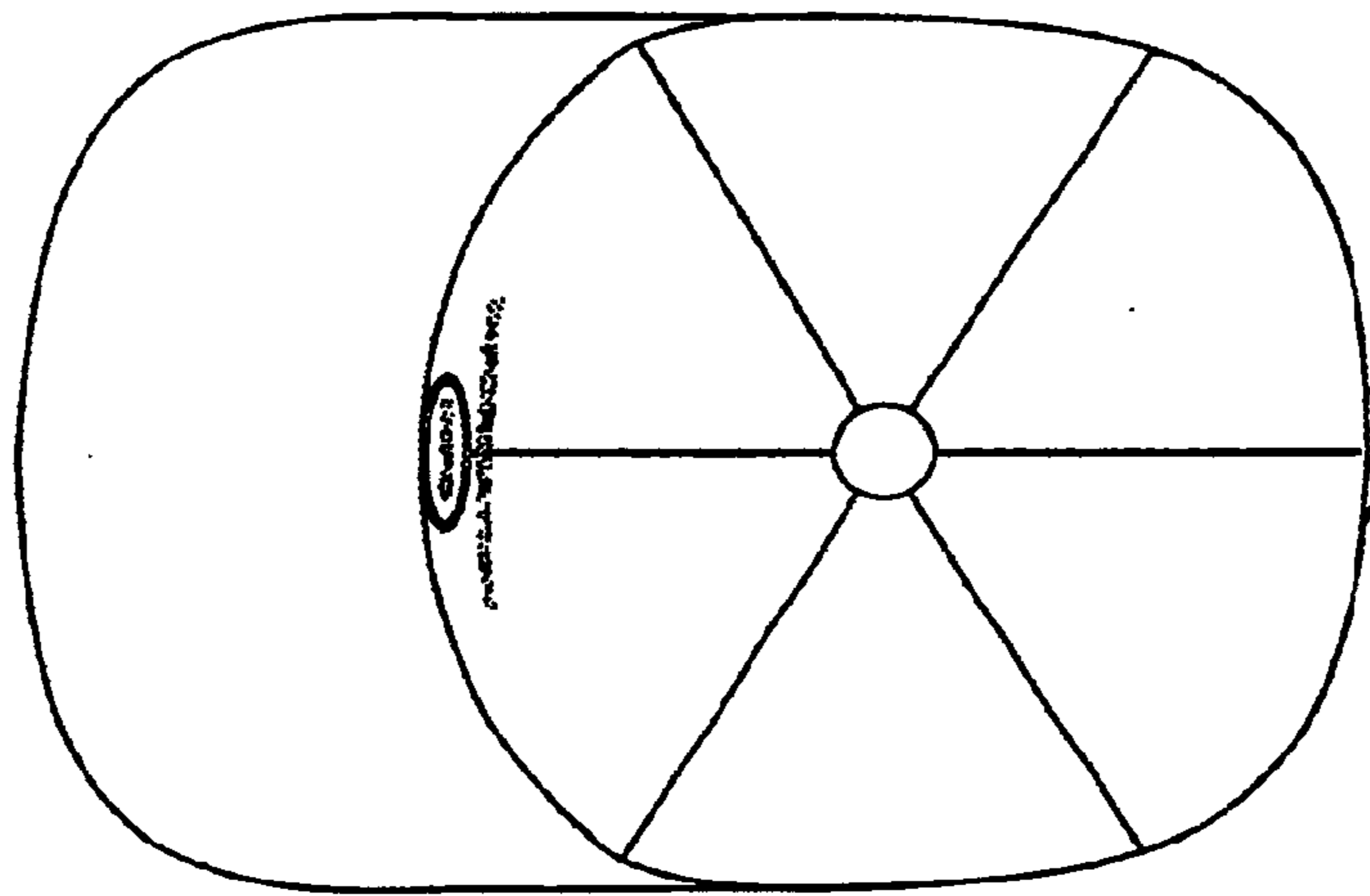
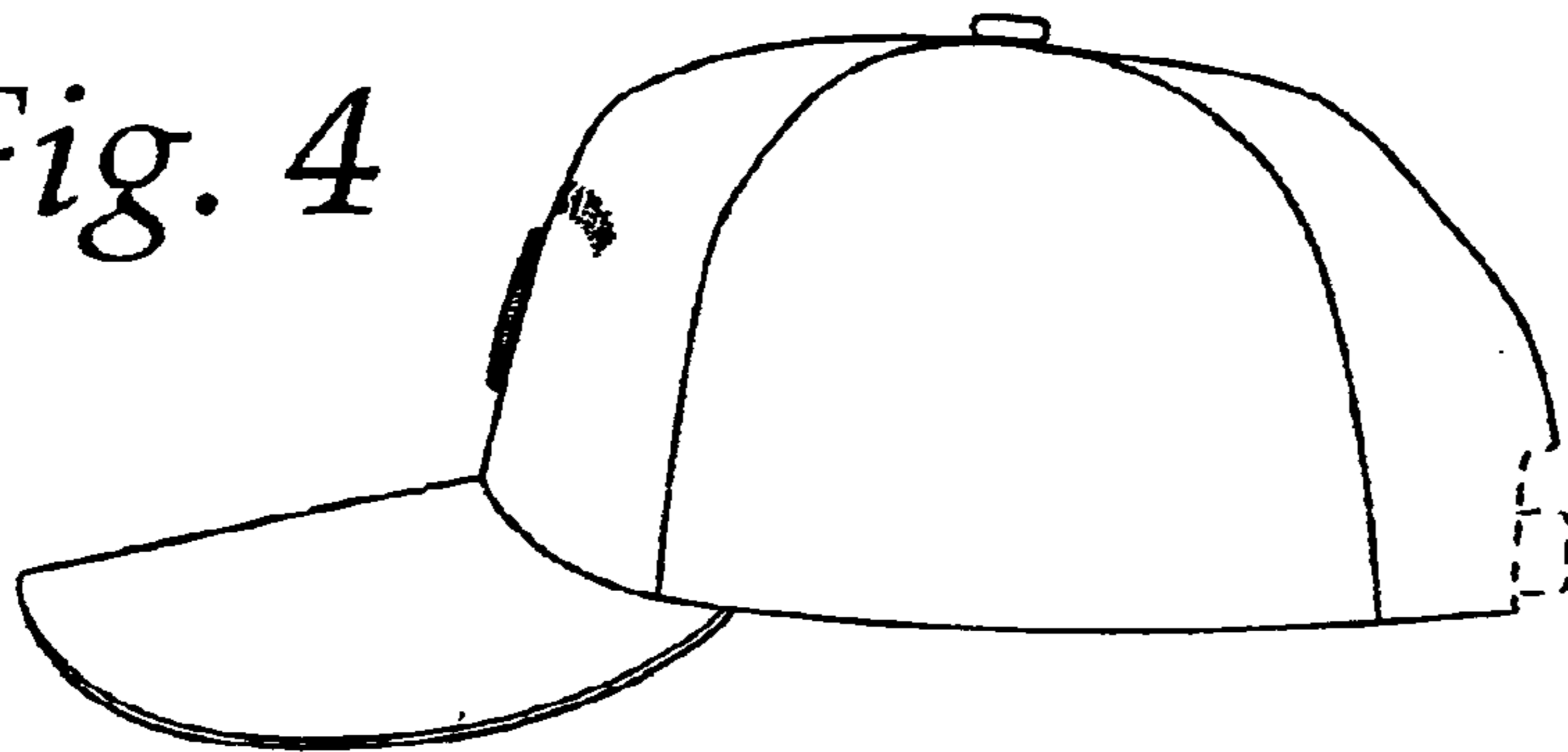

Fig. 4



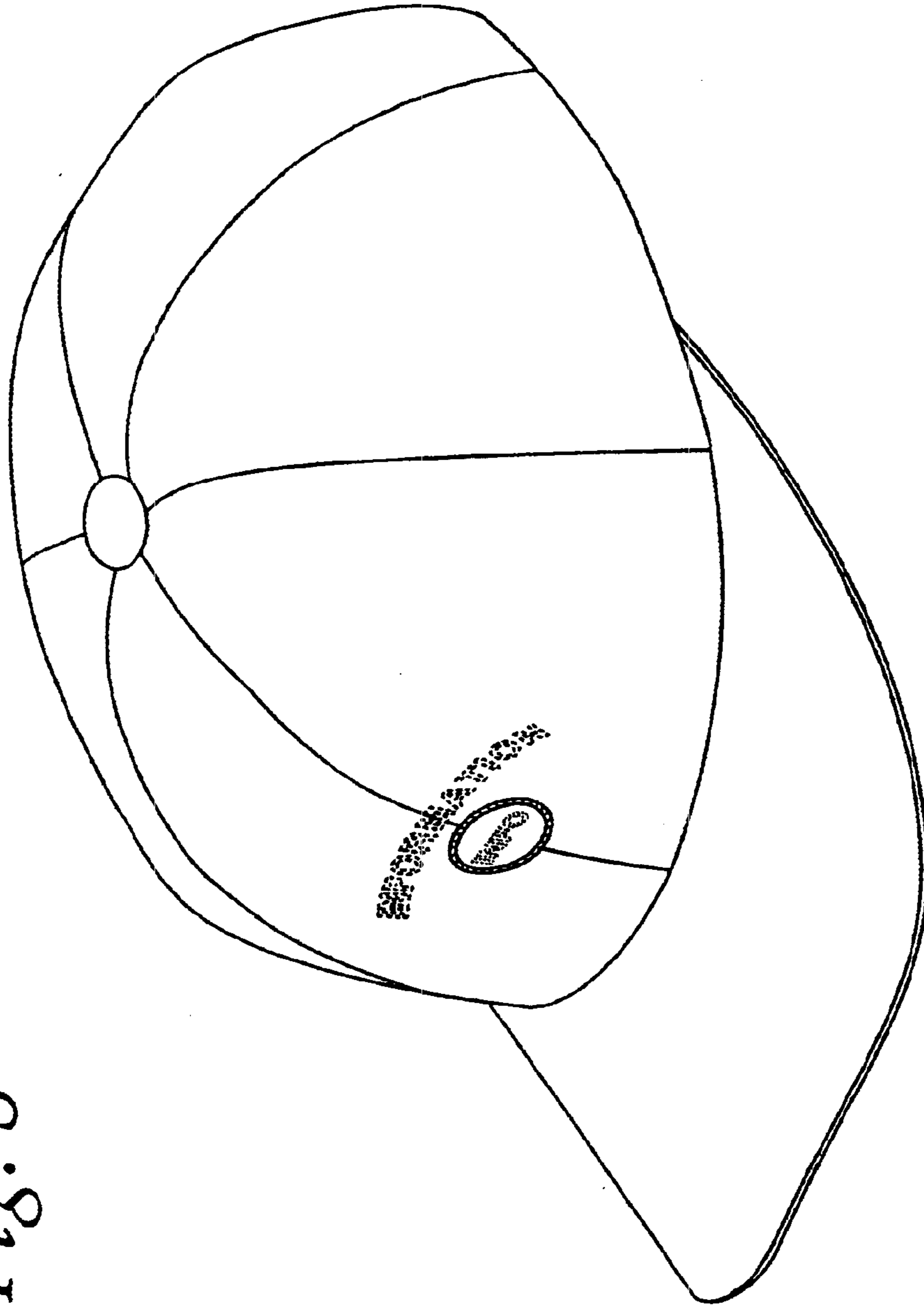

Fig. 5

Fig. 6

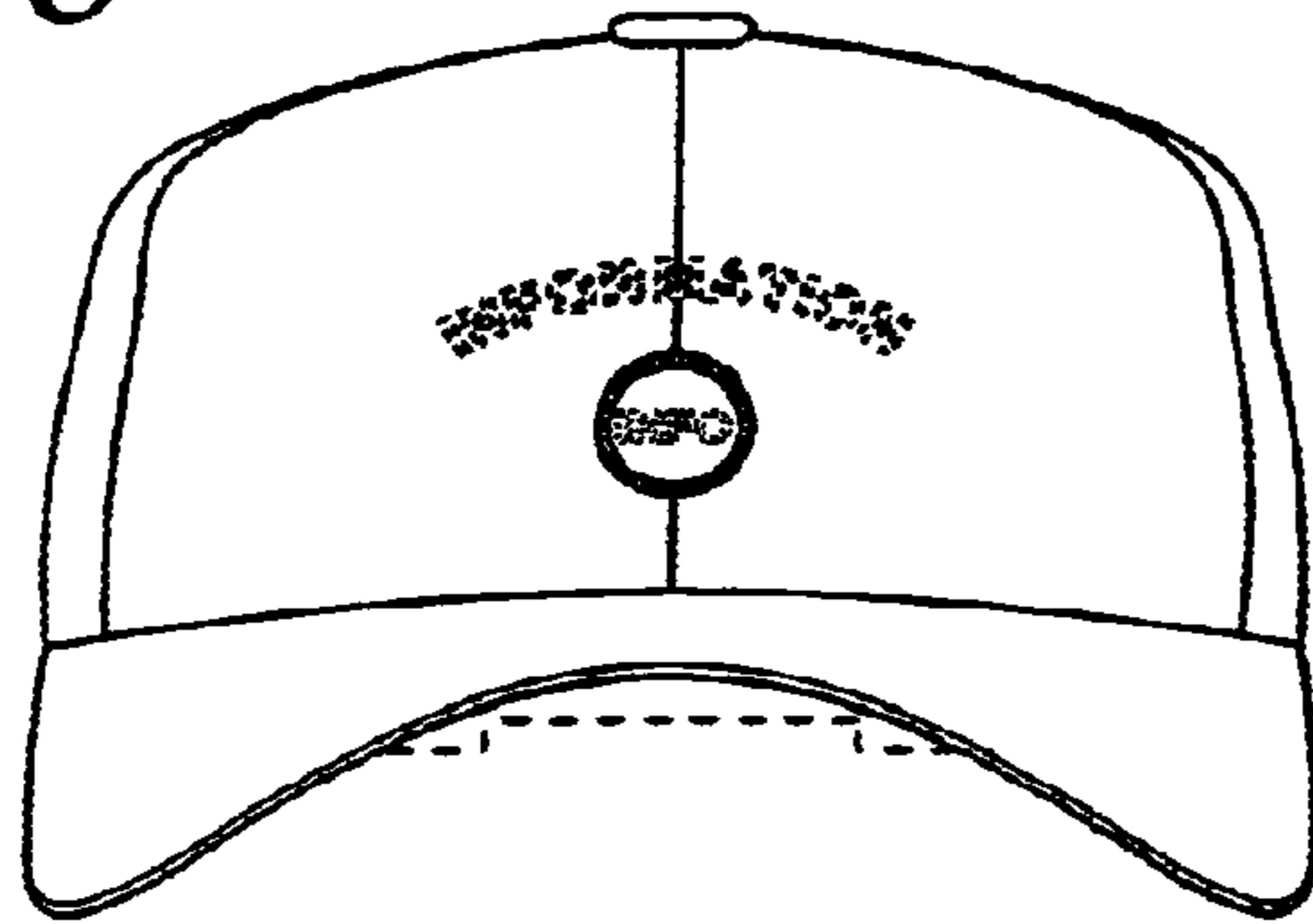

Fig. 7

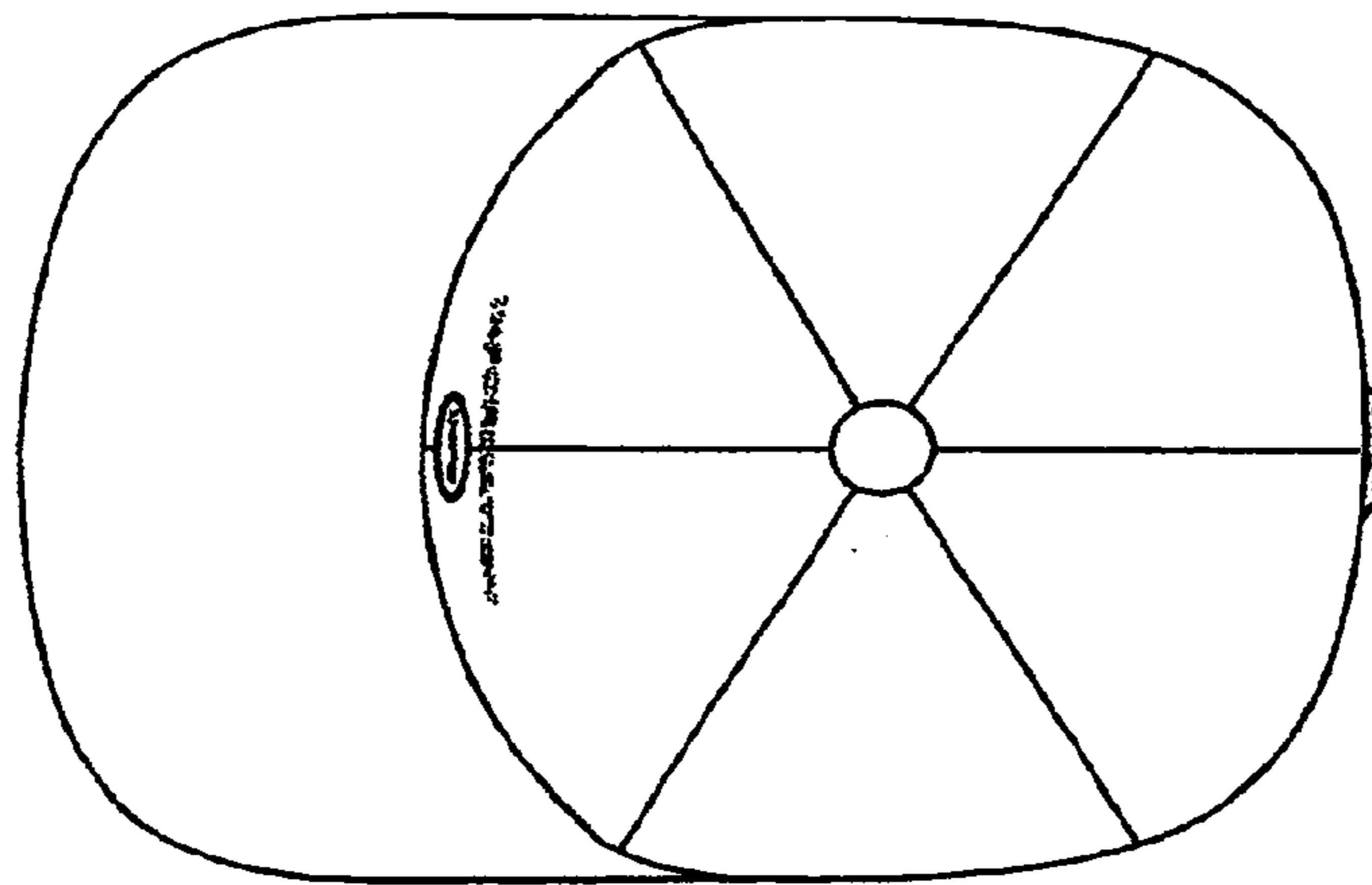

Fig. 8

