



US00D494715S1

(12) **United States Design Patent** (10) **Patent No.:** **US D494,715 S**  
**Reid** (45) **Date of Patent:** **\*\* Aug. 17, 2004**

(54) **PET COLLAR KEY**  
(75) **Inventor:** **Alister Peter Reid**, London (GB)  
(73) **Assignee:** **Reilor Holdings Limited**, Preston (GB)  
(\*\*) **Term:** **14 Years**

(74) *Attorney, Agent, or Firm*—Colin P. Cahoon; William S. Wang; Carstens, Yee & Cahoon, LLP

(57) **CLAIM**

The ornamental design for a pet collar key, as shown and described.

(21) **Appl. No.:** **29/176,929**  
(22) **Filed:** **Feb. 28, 2003**  
(30) **Foreign Application Priority Data**  
Aug. 29, 2002 (GB) ..... 3006560  
(51) **LOC (7) Cl.** ..... **30-08**  
(52) **U.S. Cl.** ..... **D30/155**  
(58) **Field of Search** ..... D30/155, 199,  
D30/160, 152; 119/792, 858; D11/224

**DESCRIPTION**

FIG. 1 is a front elevation view of the pet collar key of the present invention;  
FIG. 2 is a rear elevation view of the pet collar key of the present invention;  
FIG. 3 is a left elevation view of the pet collar key of the present invention;  
FIG. 4 is a right elevation view of the pet collar key of the present invention;  
FIG. 5 is a bottom elevation view of the pet collar key of the present invention; and,  
FIG. 6 is a top elevation view of the pet collar key of the present invention.

The broken line showing of environmental structure is for illustrative purposes only and forms no part of the claimed design.

(56) **References Cited**  
**U.S. PATENT DOCUMENTS**  
6,532,903 B2 \* 3/2003 Prusia et al. .... 119/792

\* cited by examiner

*Primary Examiner*—Lisa Lichtenstein

**1 Claim, 2 Drawing Sheets**

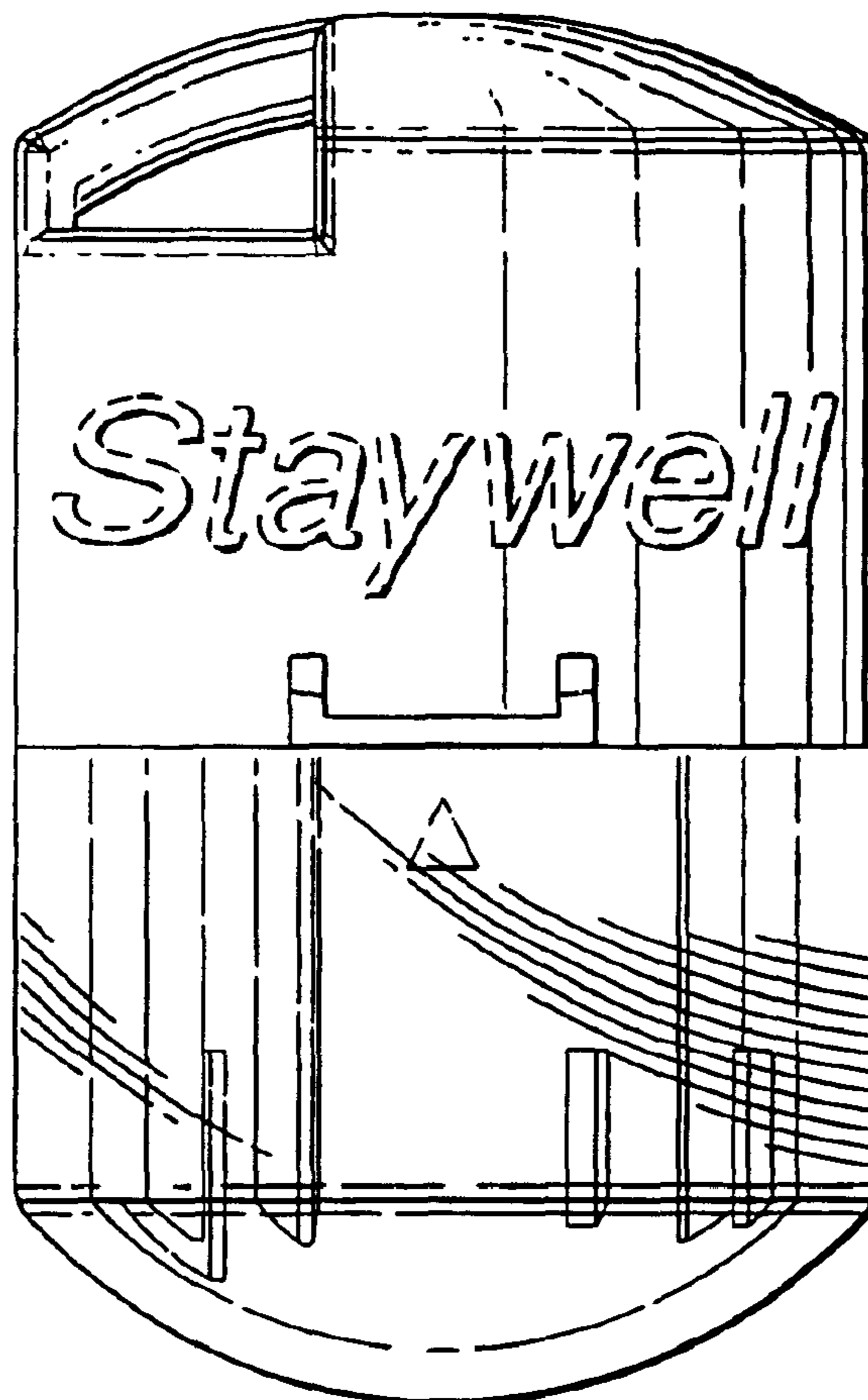

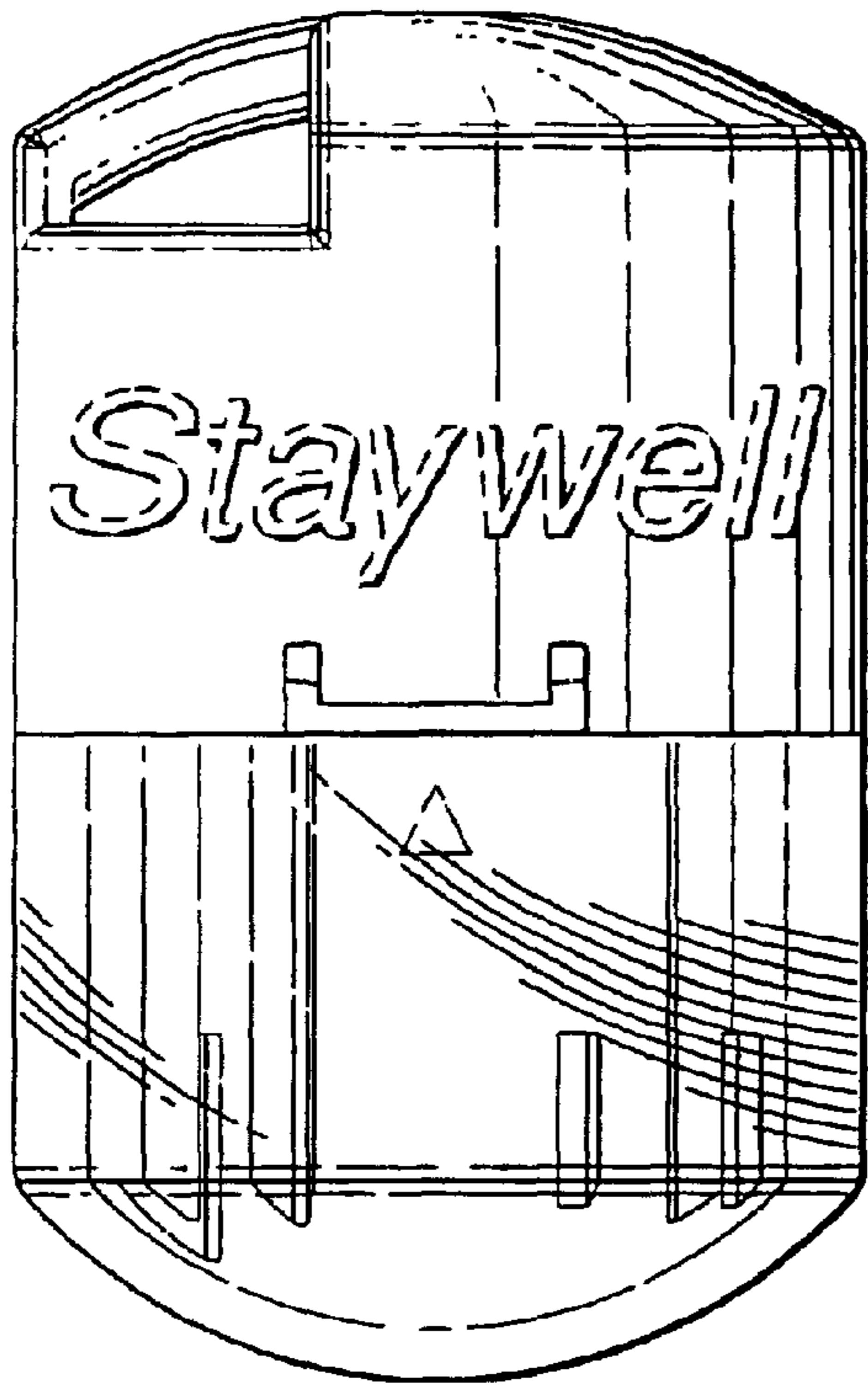

FIG. 1

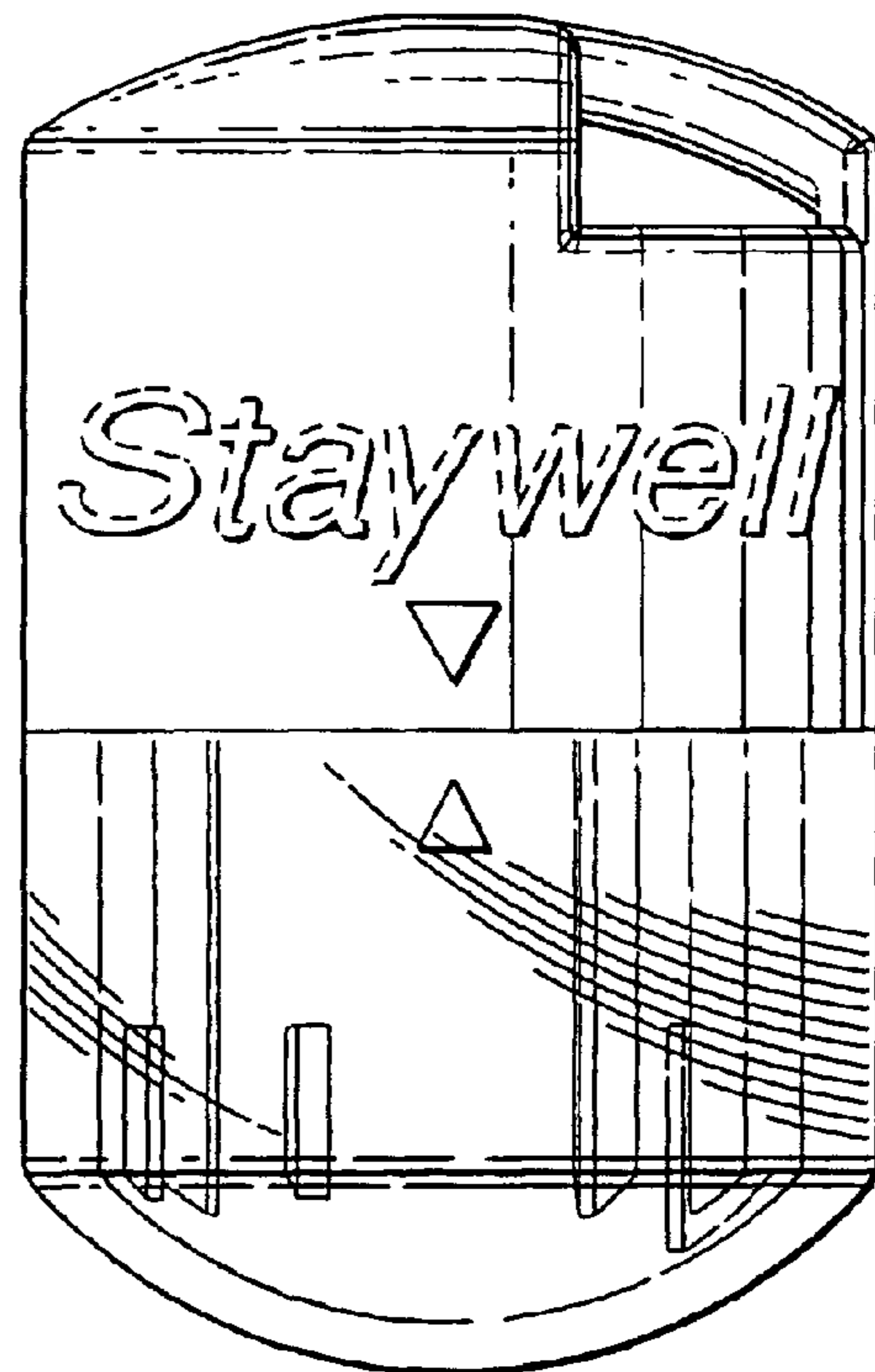

FIG. 2

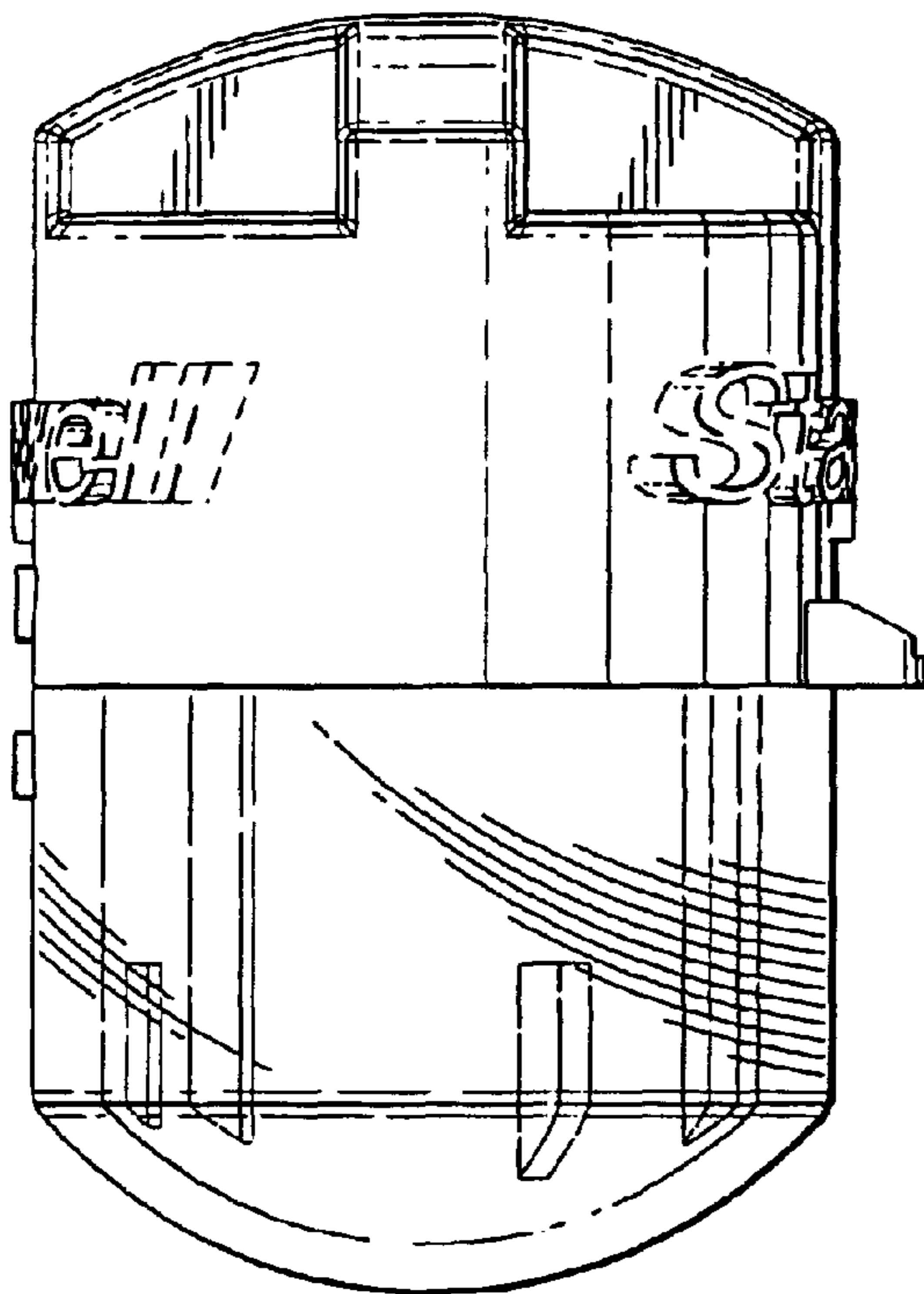

FIG. 3

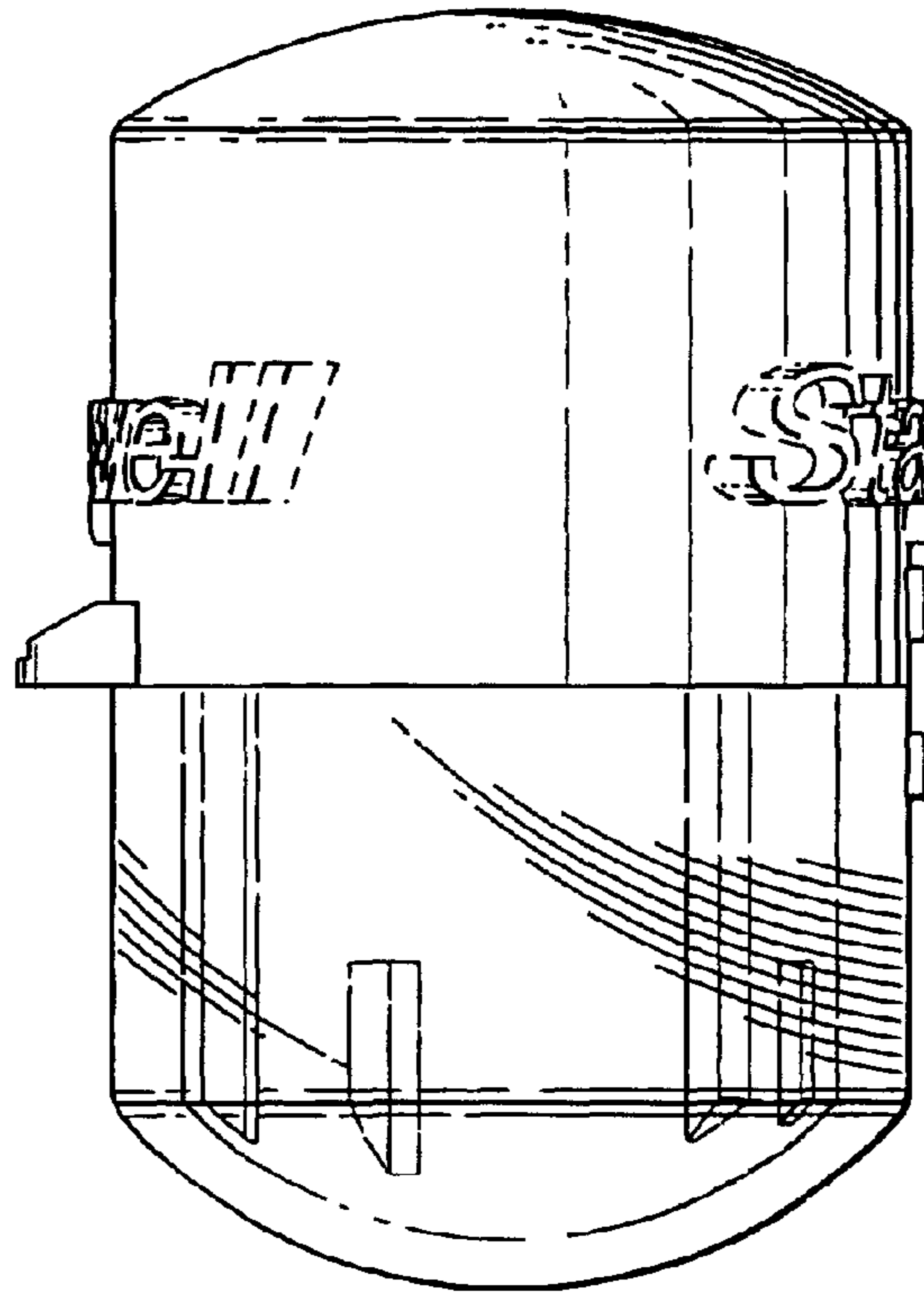

FIG. 4

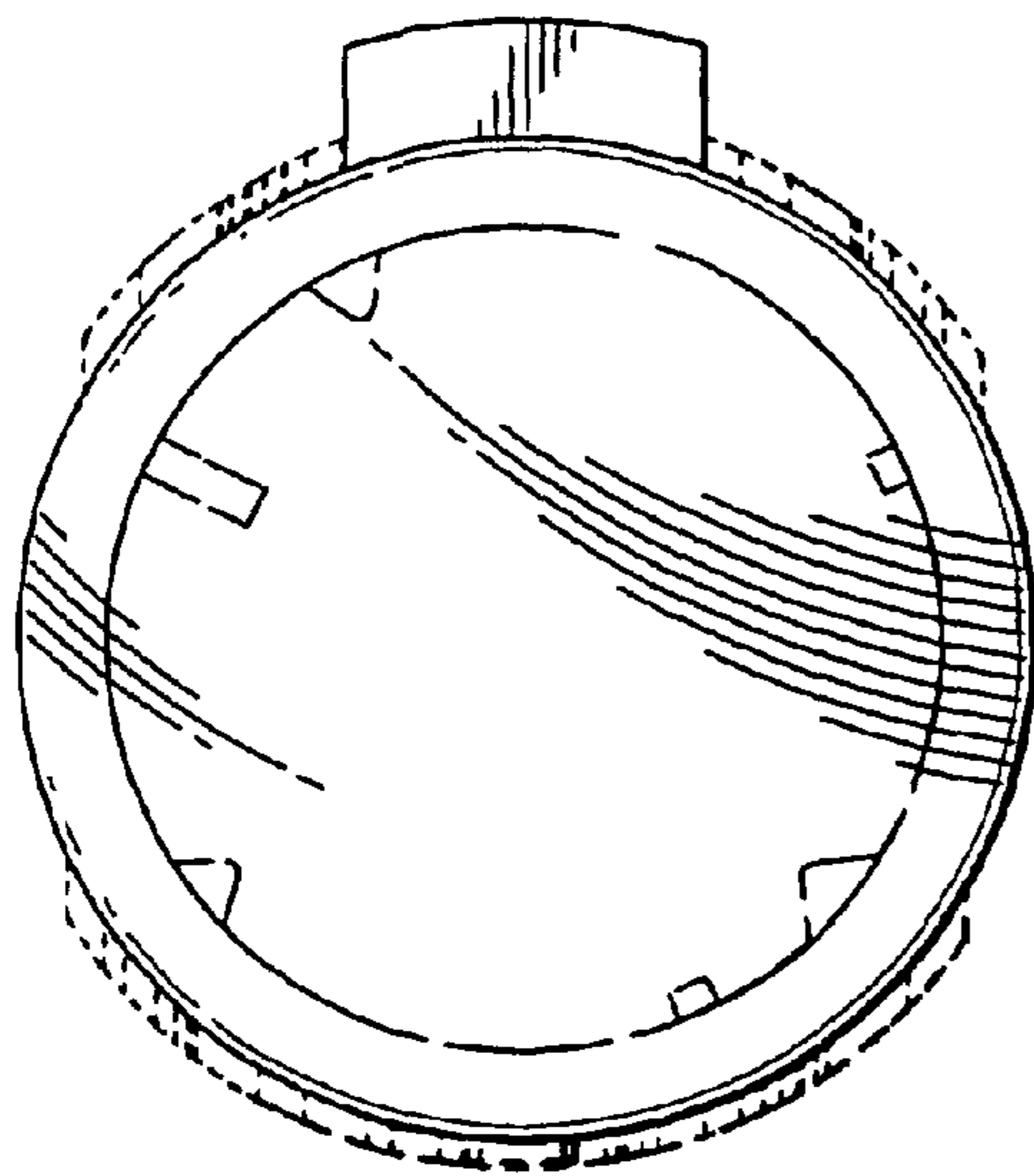

FIG. 5

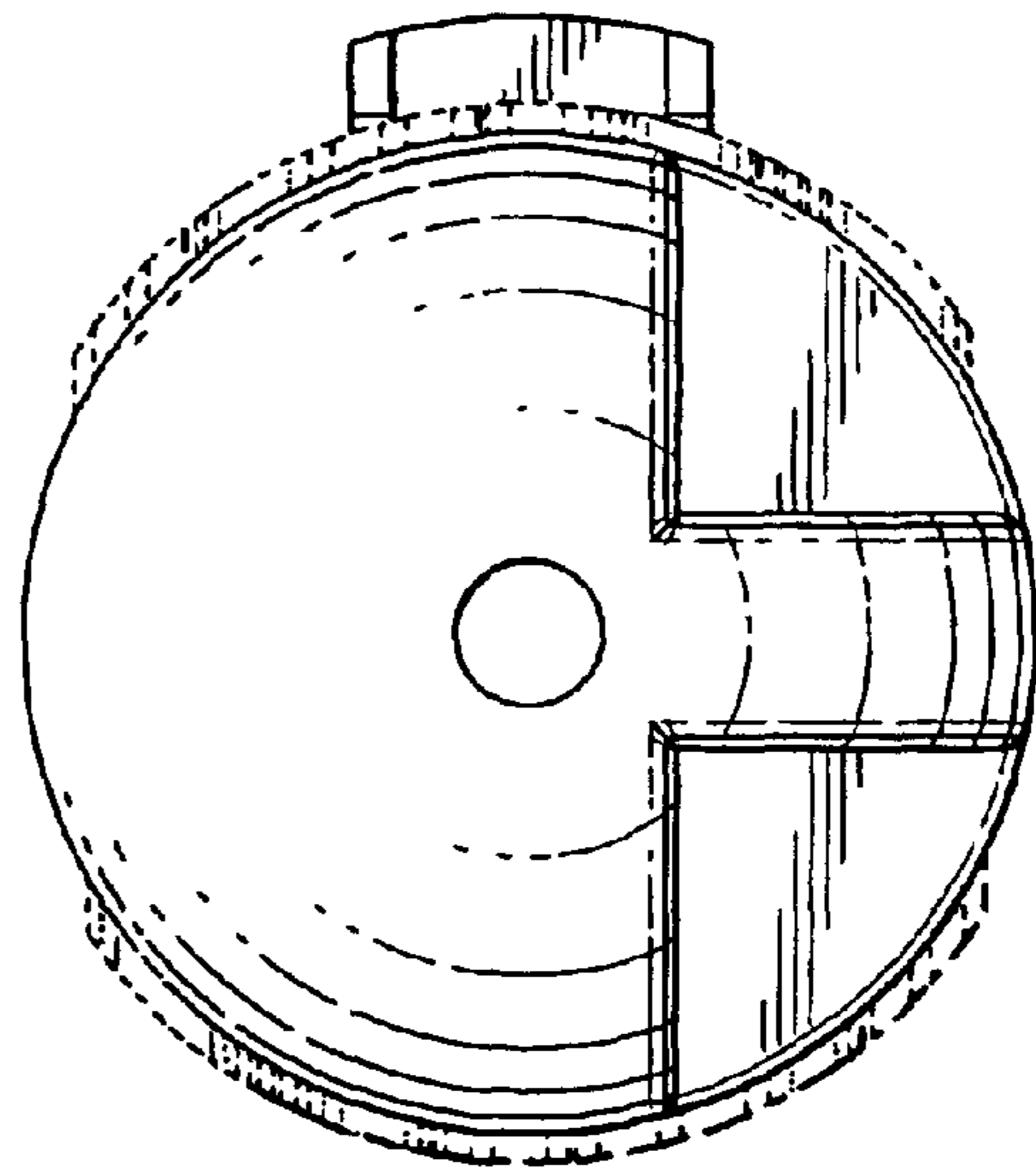

FIG. 6