

US00D494691S1

(12) **United States Design Patent**
Lee

(10) **Patent No.:** **US D494,691 S**
(45) **Date of Patent:** **** Aug. 17, 2004**

(54) **PORTABLE LIGHT DEVICE**

Primary Examiner—Marcus A Jackson

(76) **Inventor:** **Wen Sung Lee**, P.O. Box 63-298,
Taichung (TW), 406

(57) **CLAIM**

The ornamental design for a portable light device, as shown and described.

(**) **Term:** **14 Years**

(21) **Appl. No.:** **29/190,693**

DESCRIPTION

(22) **Filed:** **Sep. 22, 2003**

(51) **LOC (7) Cl.** **26-02**

FIG. 1 is a perspective view of a portable light device showing my new design;

(52) **U.S. Cl.** **D26/37**

FIG. 2 is a front elevational view thereof;

(58) **Field of Search** D26/37-50; 362/157,
362/158, 171-174, 183-208

FIG. 3 is a rear elevational view thereof;

FIG. 4 is a top plan view thereof;

(56) **References Cited**

U.S. PATENT DOCUMENTS

D407,509 S * 3/1999 Yuen D26/37

FIG. 5 is a bottom plan view thereof;

D484,996 S * 1/2004 Krieger et al. D26/37

FIG. 6 is a left side elevational view thereof; and,

D486,256 S * 2/2004 Yuen D26/37

FIG. 7 is a right side elevational view thereof.

* cited by examiner

1 Claim, 6 Drawing Sheets

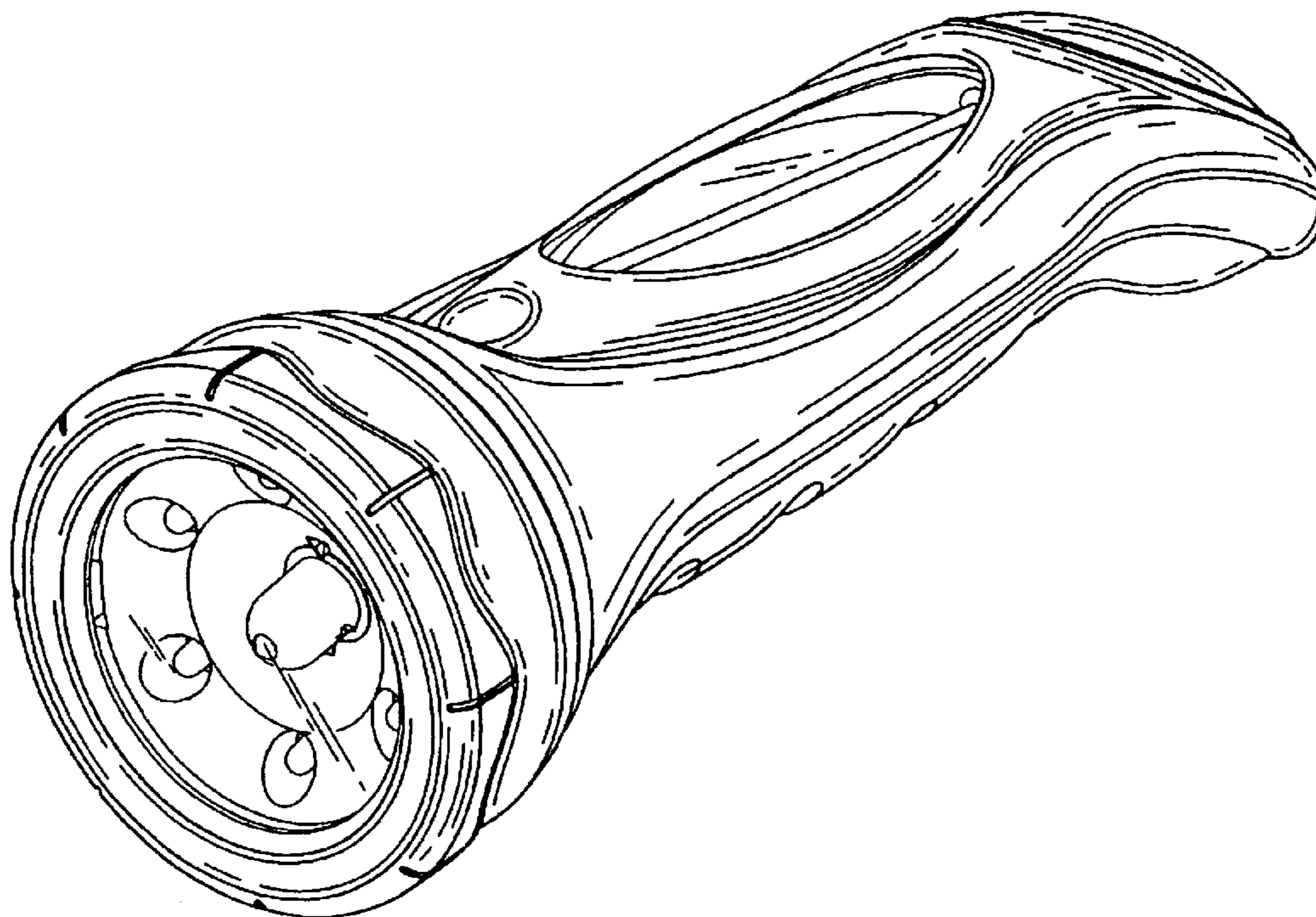

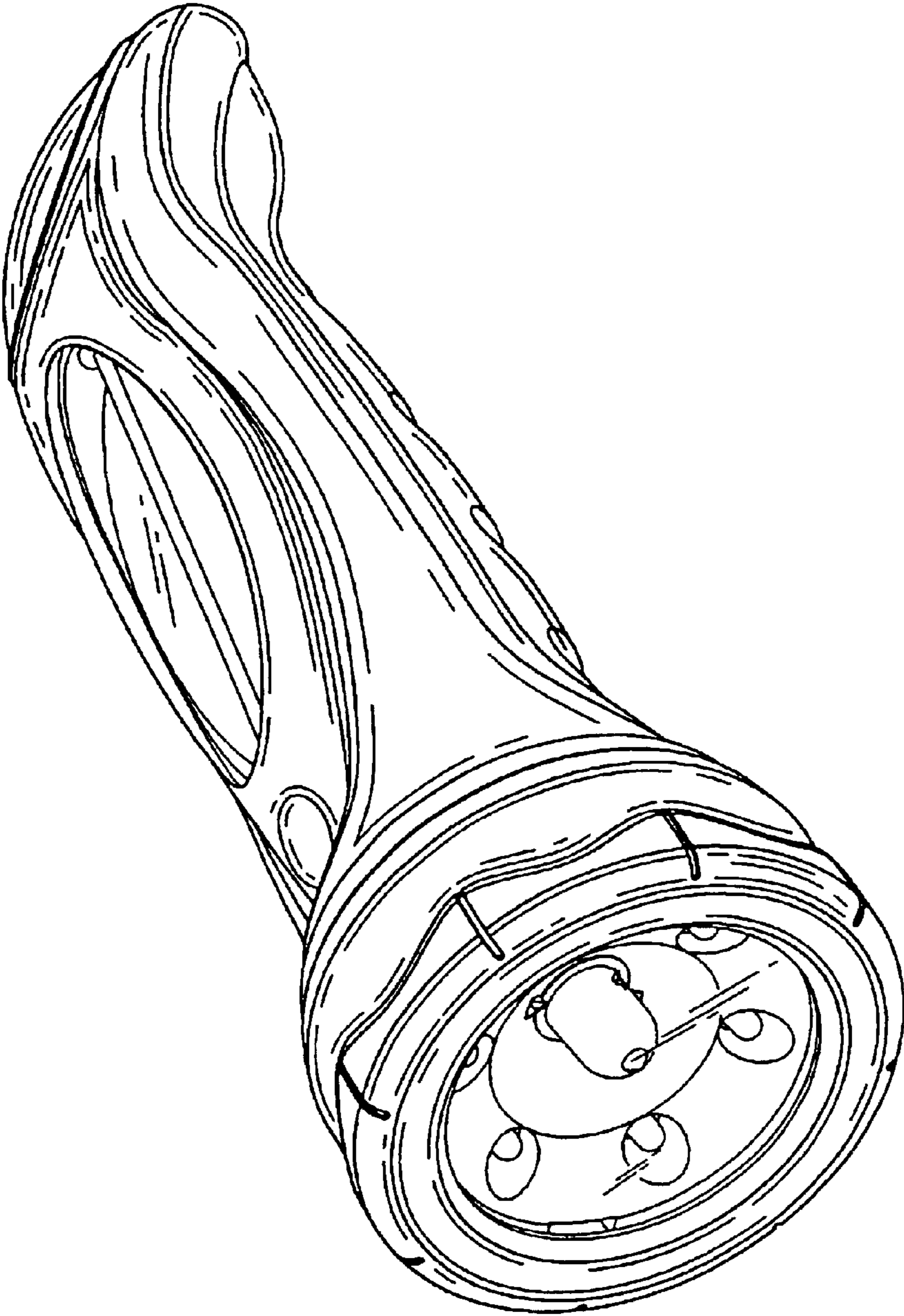

FIG. 1

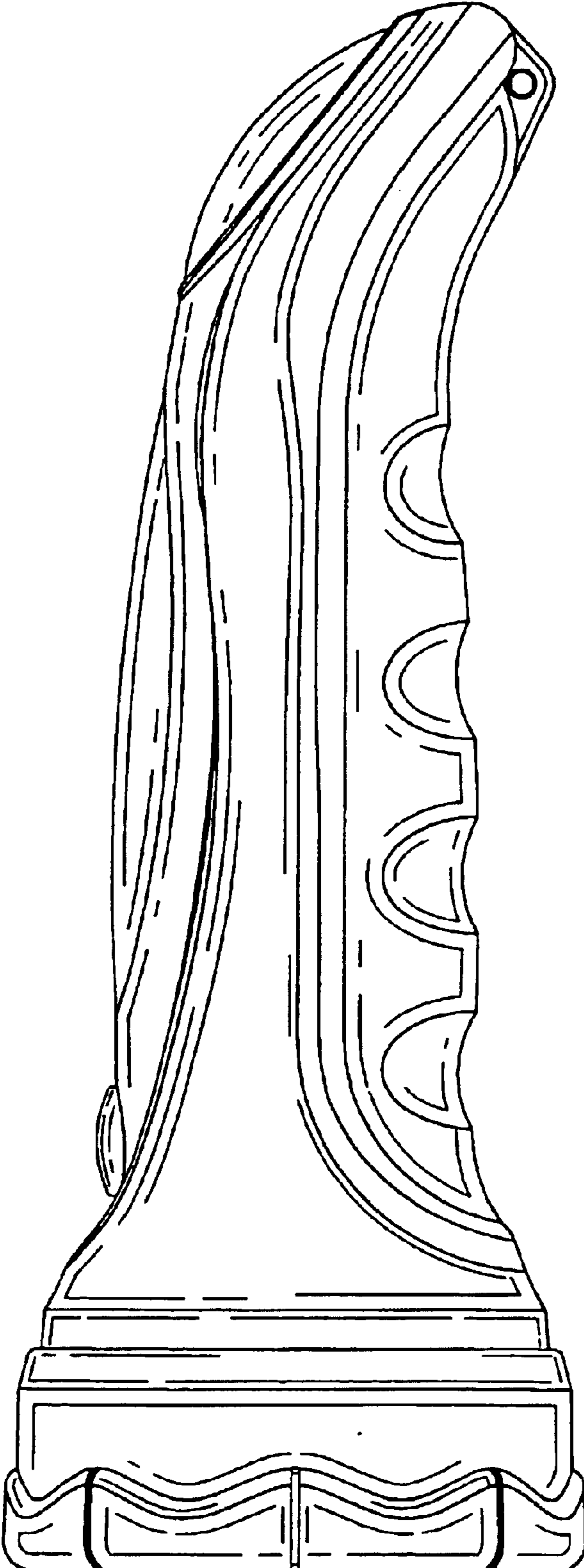

FIG. 2

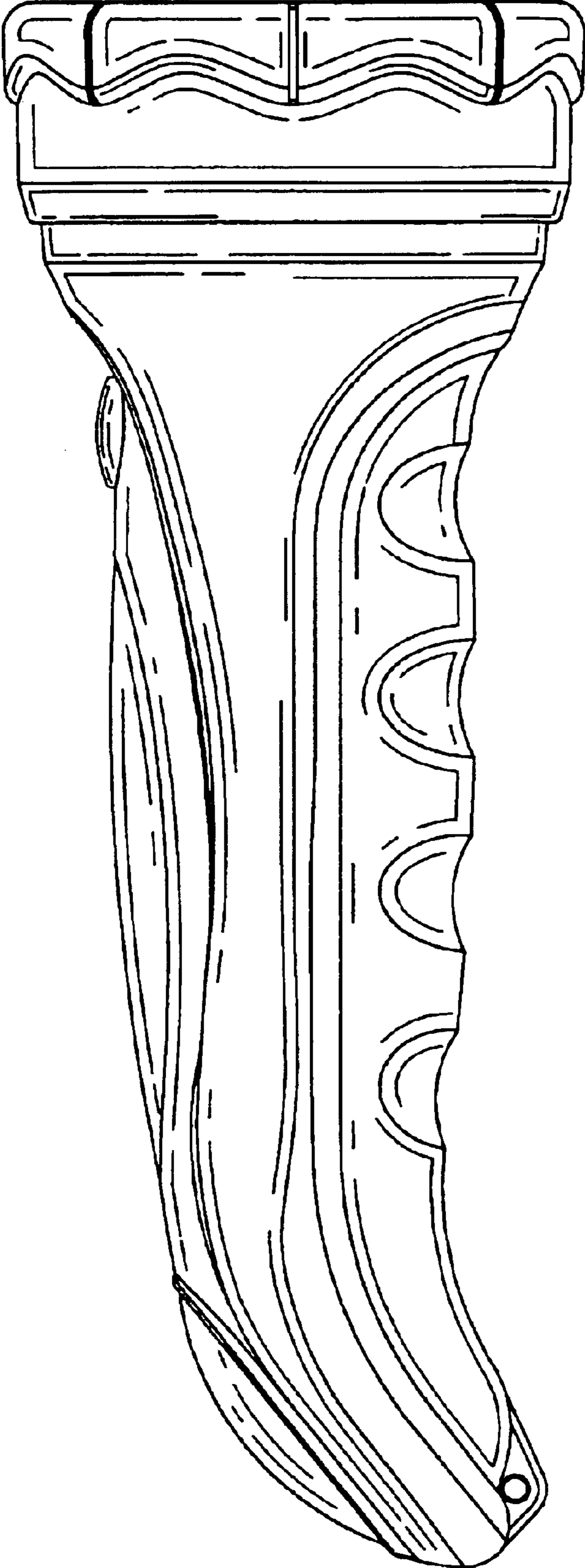

FIG. 3

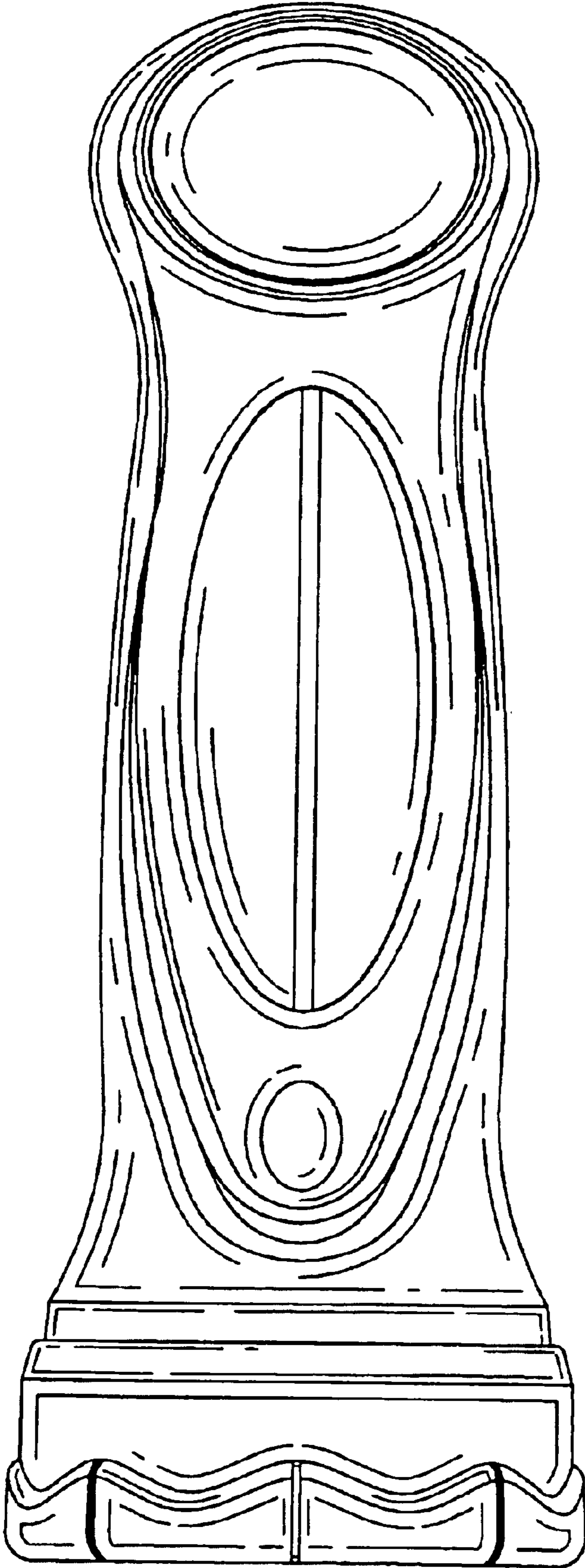

FIG. 4

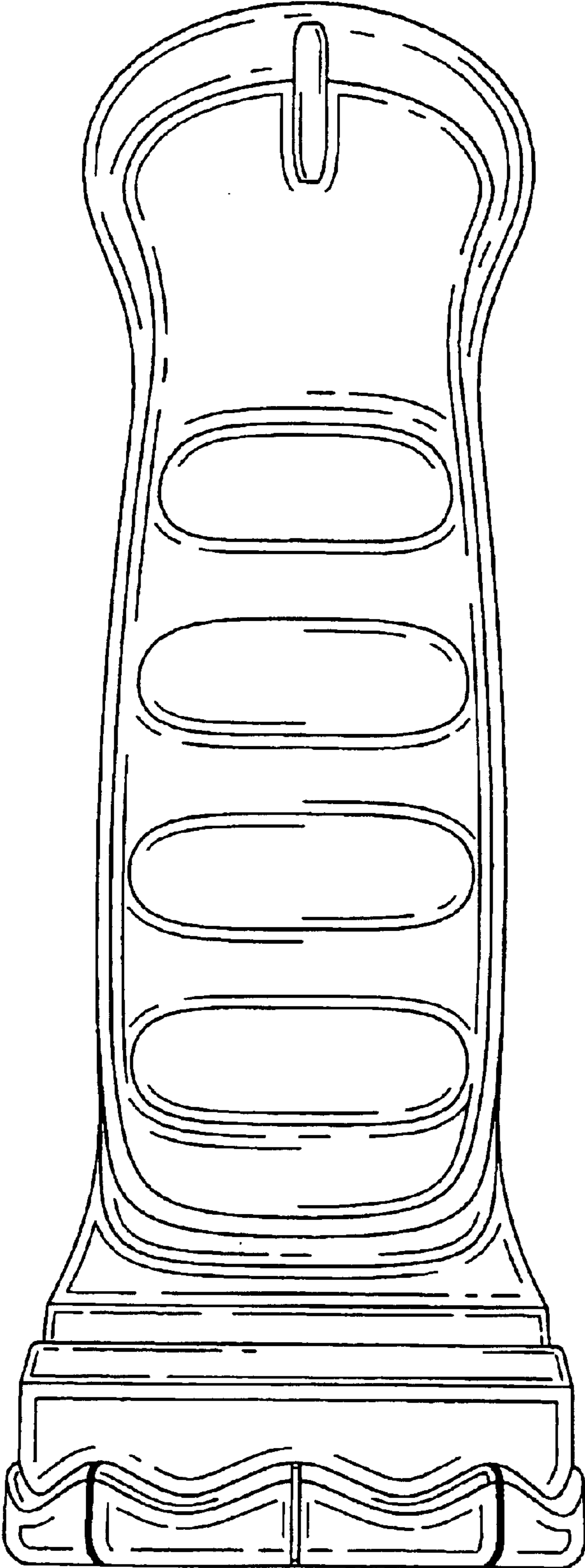

FIG. 5

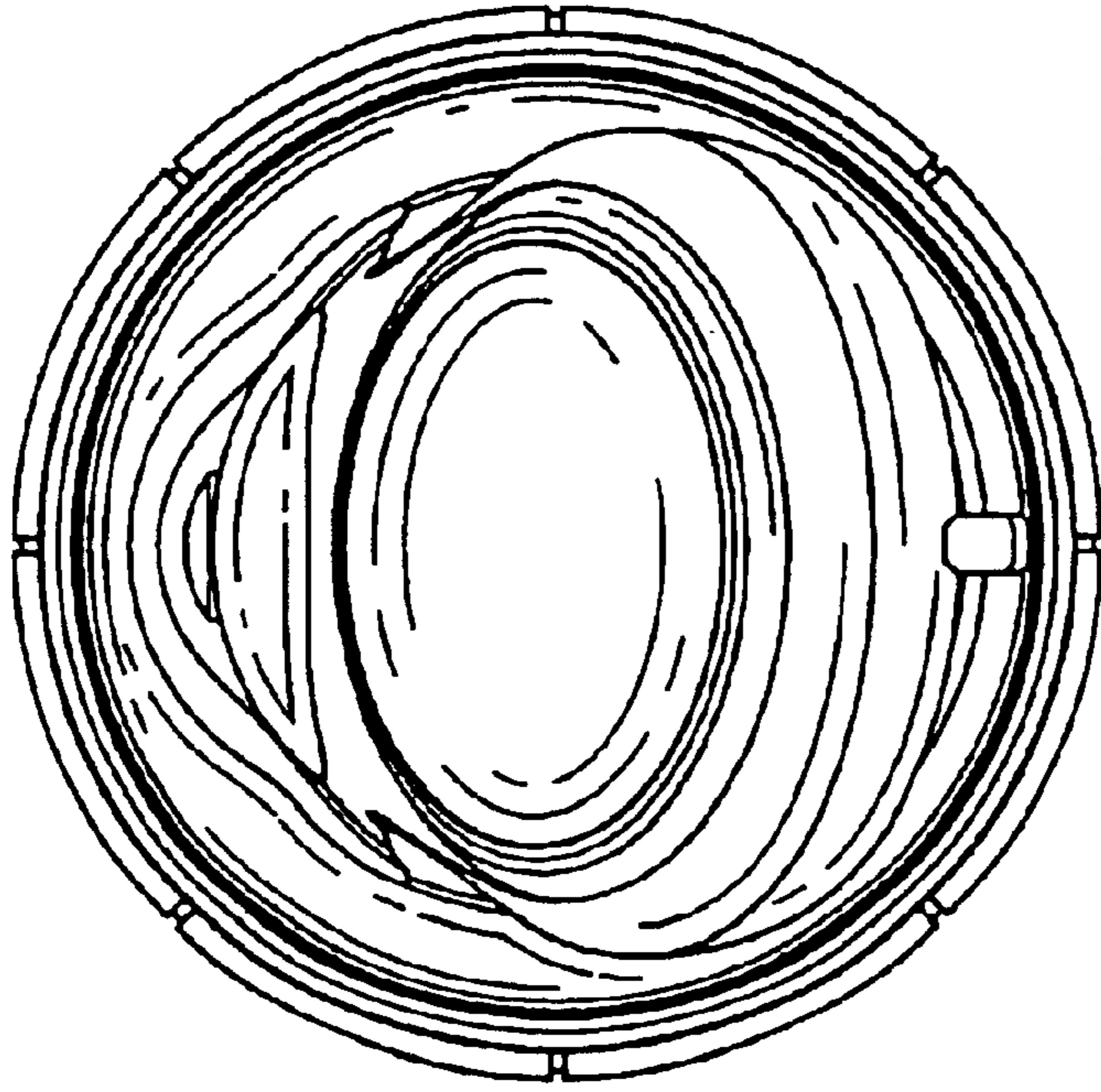

FIG. 6

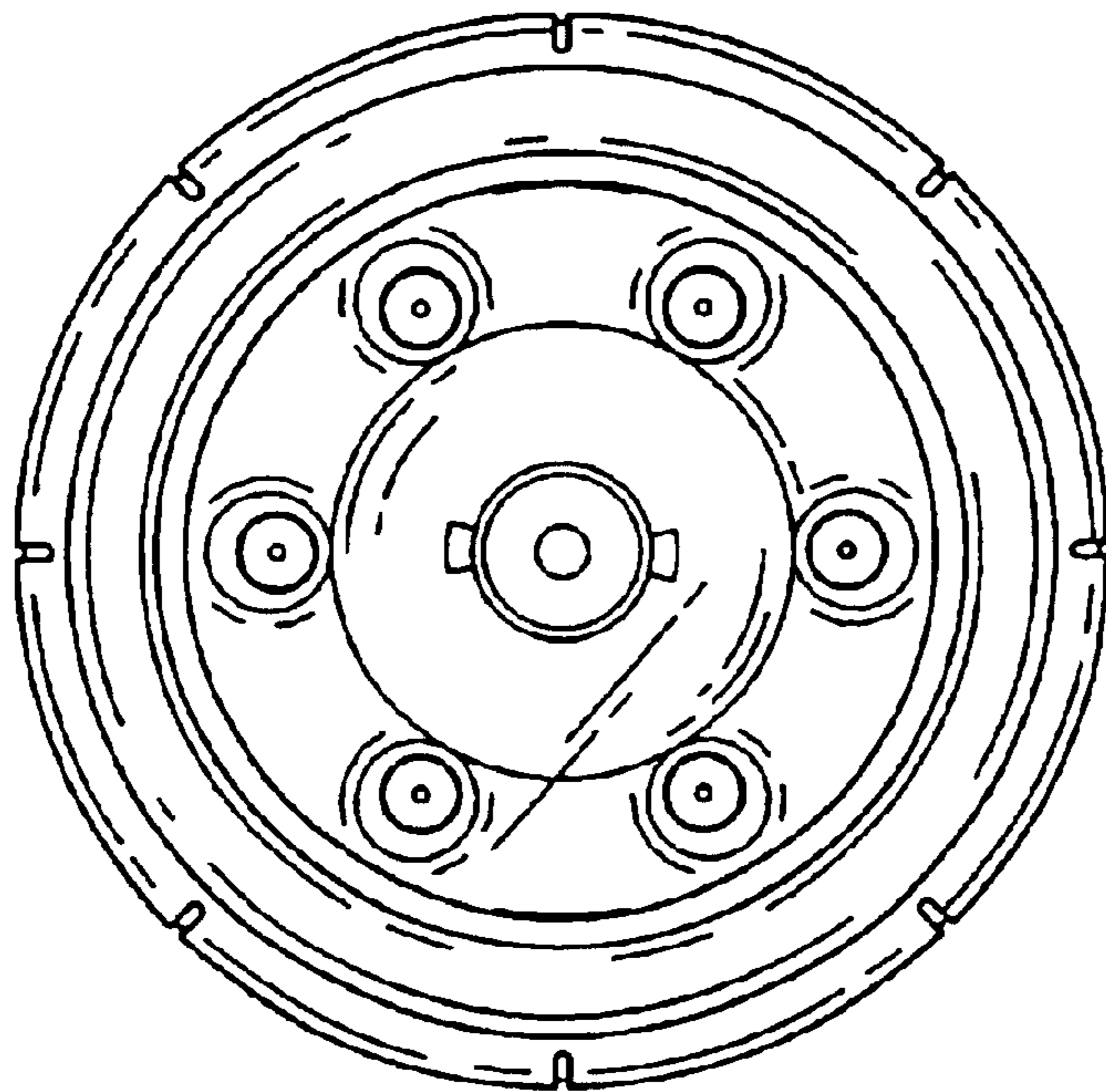

FIG. 7