

US00D494687S1

(12) **United States Design Patent** (10) **Patent No.:** **US D494,687 S**  
**Matsui et al.** (45) **Date of Patent:** **\*\* Aug. 17, 2004**

(54) **LIGHT EMITTING DIODE LAMP**

(75) Inventors: **Nobuyuki Matsui, Osaka (JP);  
Masanori Shimizu, Kyoto (JP)**

(73) Assignee: **Matsushita Electric Industrial Co.,  
Ltd., Kadoma (JP)**

(\*\*) Term: **14 Years**

(21) Appl. No.: **29/187,021**

(22) Filed: **Jul. 24, 2003**

(30) **Foreign Application Priority Data**

Jan. 27, 2003 (JP) ..... 2003-001670

(51) **LOC (7) Cl.** ..... **26-06**

(52) **U.S. Cl.** ..... **D26/2; D13/180**

(58) **Field of Search** ..... **D26/2; D13/180;**  
313/113, 315, 317, 318, 493, 500, 512;  
315/56; 345/83; 362/231, 235, 237, 249,  
545, 555

(56) **References Cited**

**U.S. PATENT DOCUMENTS**

D262,405 S \* 12/1981 Zabransky ..... D26/2  
5,808,592 A \* 9/1998 Mizutani et al. .... 345/83  
6,220,722 B1 \* 4/2001 Begemann ..... 362/231  
6,502,956 B1 \* 1/2003 Wu ..... 362/237  
D474,848 S \* 5/2003 Lodhie ..... D26/2

6,659,632 B2 \* 12/2003 Chen ..... 362/545  
2003/0025450 A1 \* 2/2003 Katayama et al. .... 313/512  
2003/0117803 A1 \* 6/2003 Chen ..... 362/276  
2003/0189829 A1 \* 10/2003 Shimizu et al. .... 362/240

**FOREIGN PATENT DOCUMENTS**

JP 808266 2/1991  
JP 808267 2/1991

\* cited by examiner

*Primary Examiner*—Philip S. Hyder

*Assistant Examiner*—Selina Sikder

(74) *Attorney, Agent, or Firm*—Christensen O'Connor  
Johnson Kindness PLLC

(57) **CLAIM**

The ornamental design for a light emitting diode lamp, as shown and described.

**DESCRIPTION**

FIG. 1 is a perspective view of the top, front and right side of a light emitting diode lamp showing our new design;  
FIG. 2 is a front view thereof;  
FIG. 3 is a rear view thereof;  
FIG. 4 is a left side view thereof;  
FIG. 5 is a right side view thereof;  
FIG. 6 is a top plan view thereof; and,  
FIG. 7 is a bottom view thereof.

**1 Claim, 2 Drawing Sheets**

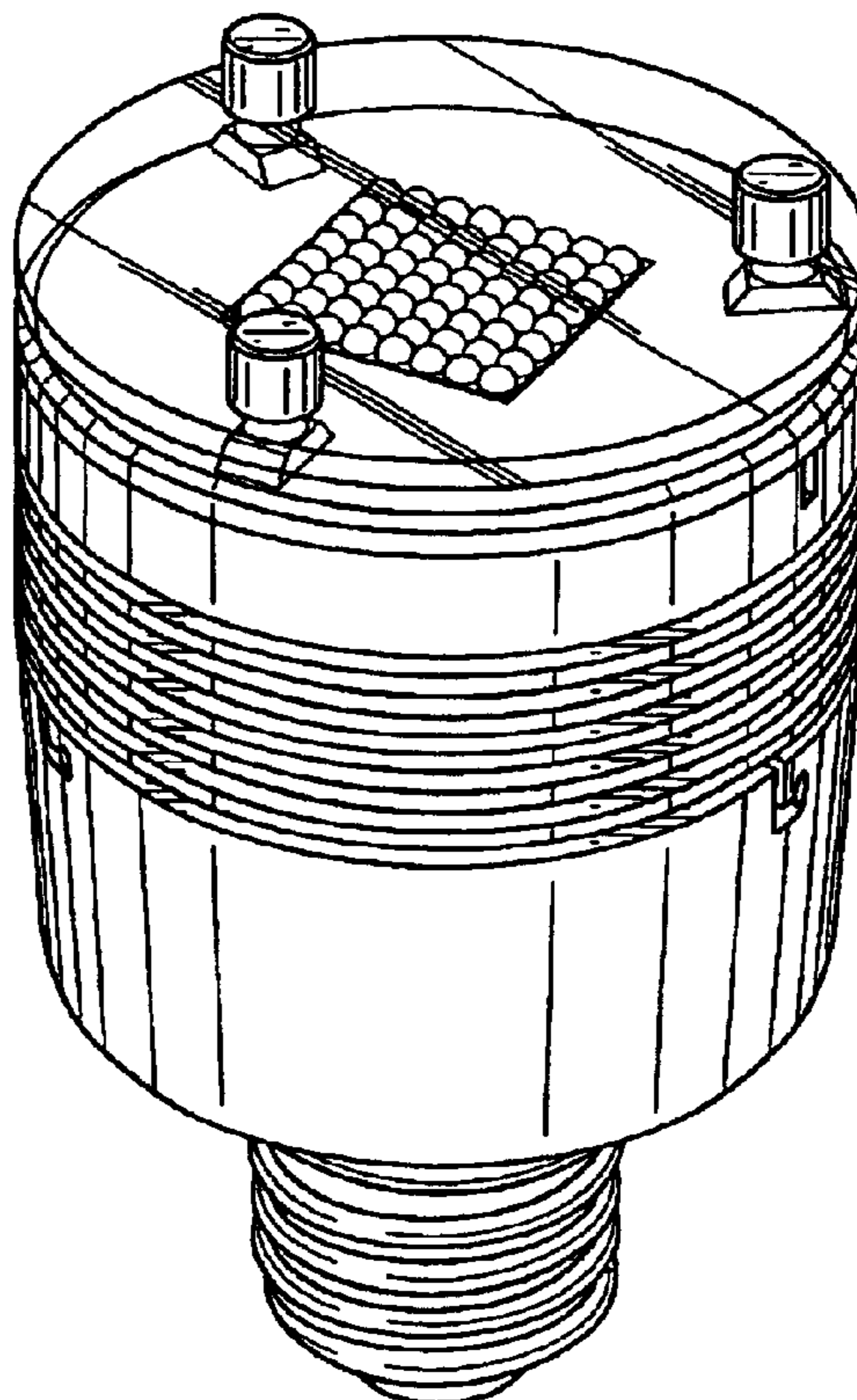

*FIG. 1*

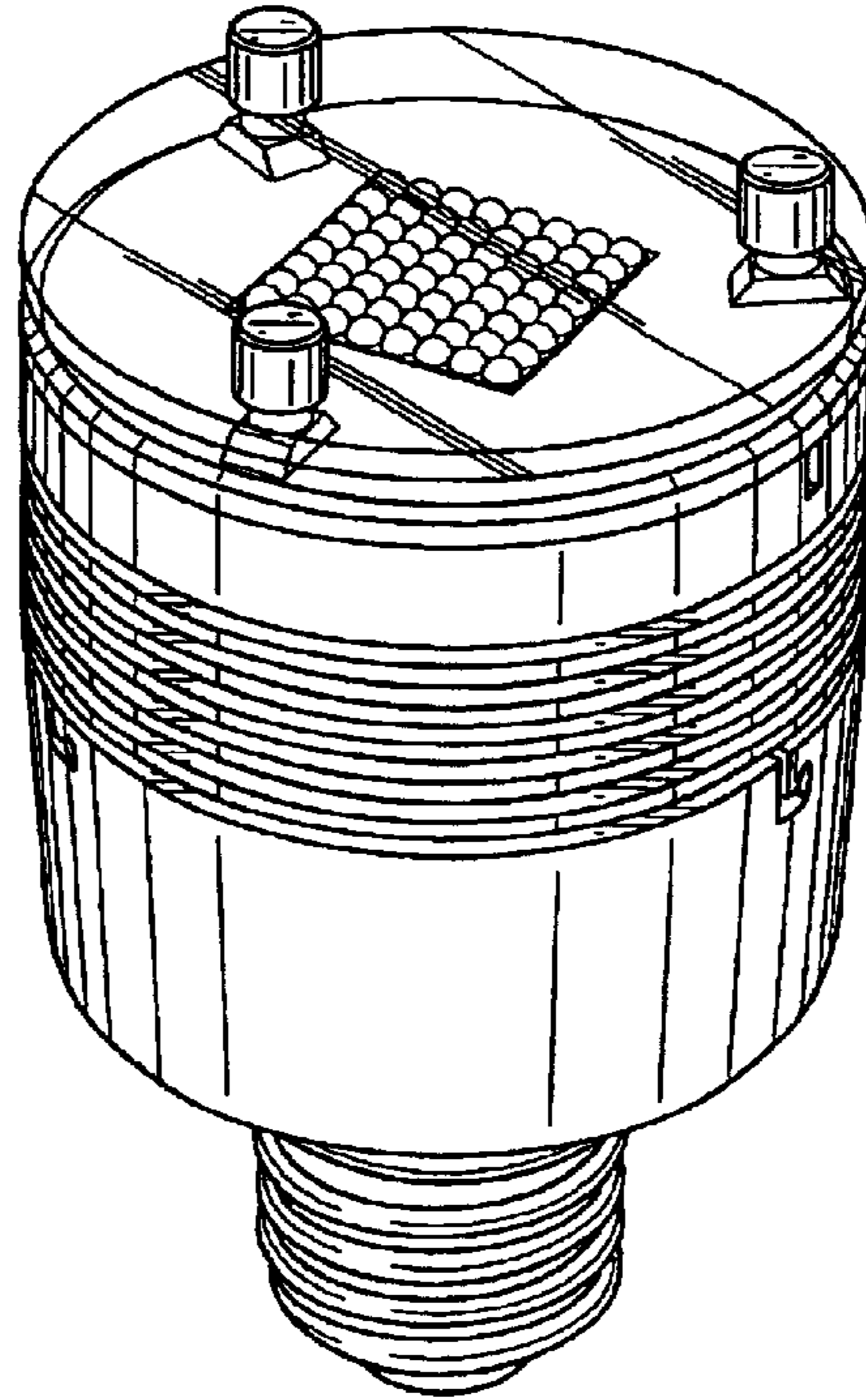

*FIG. 2*

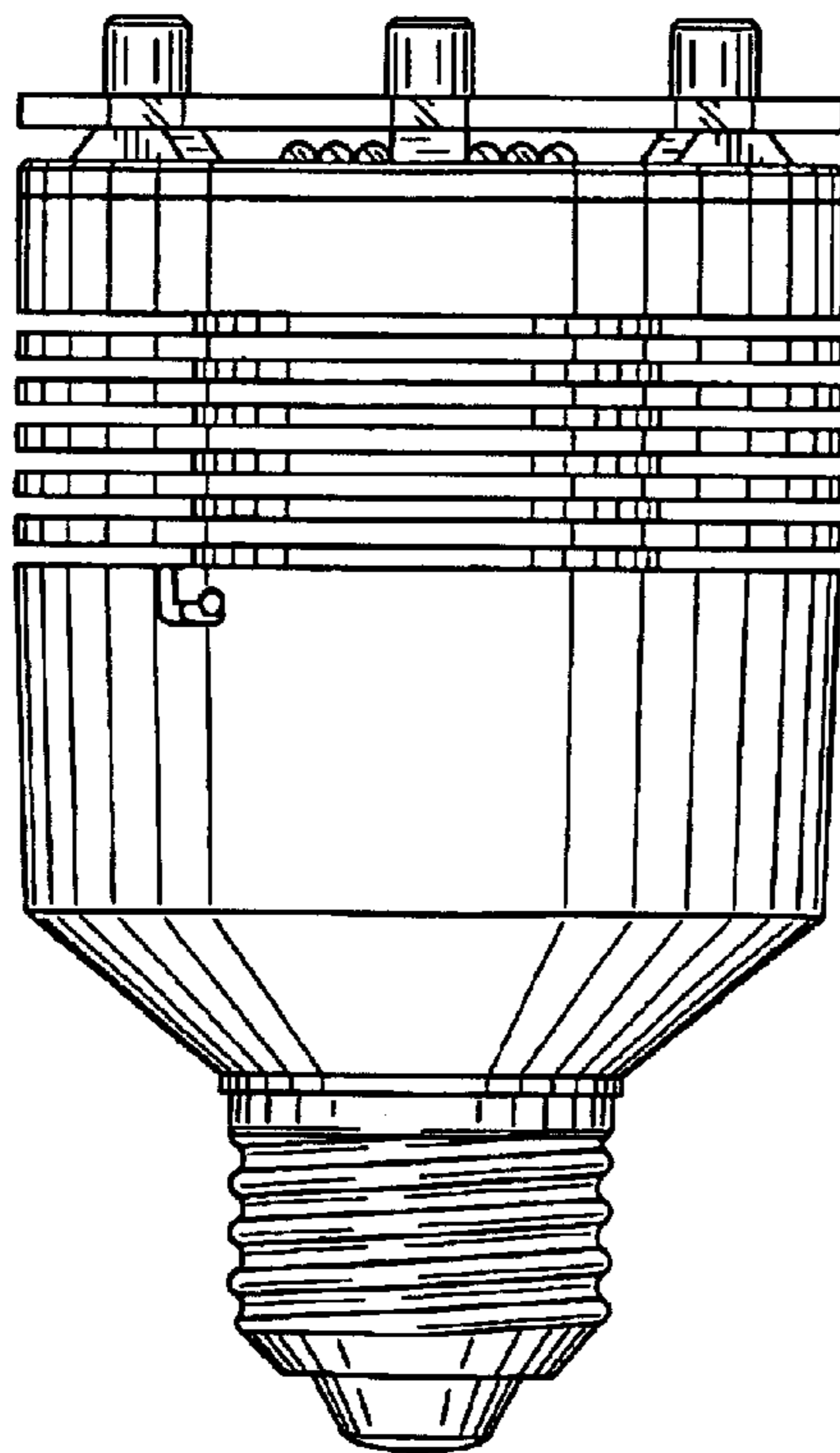

*FIG. 3*

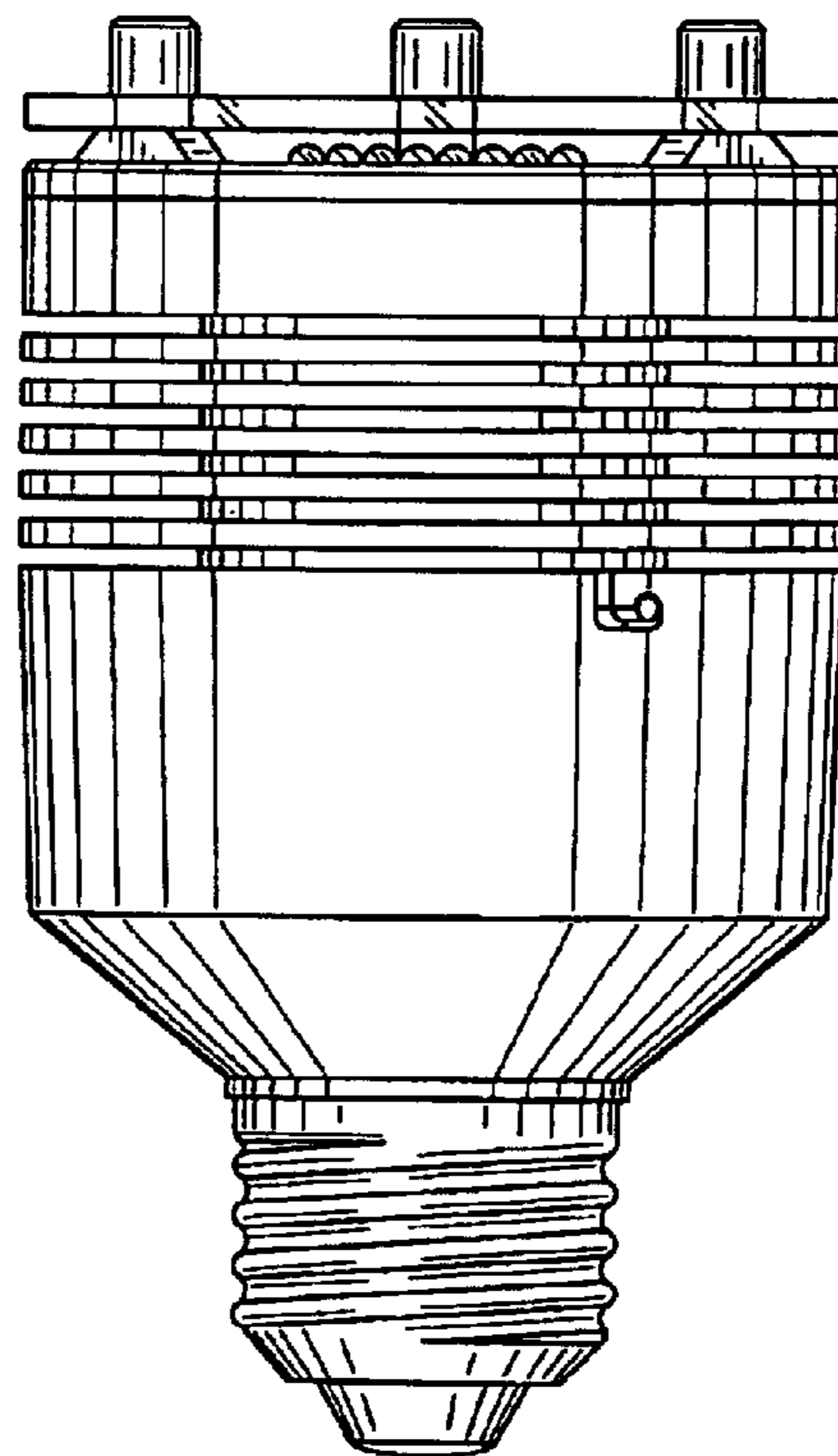

*FIG. 4*

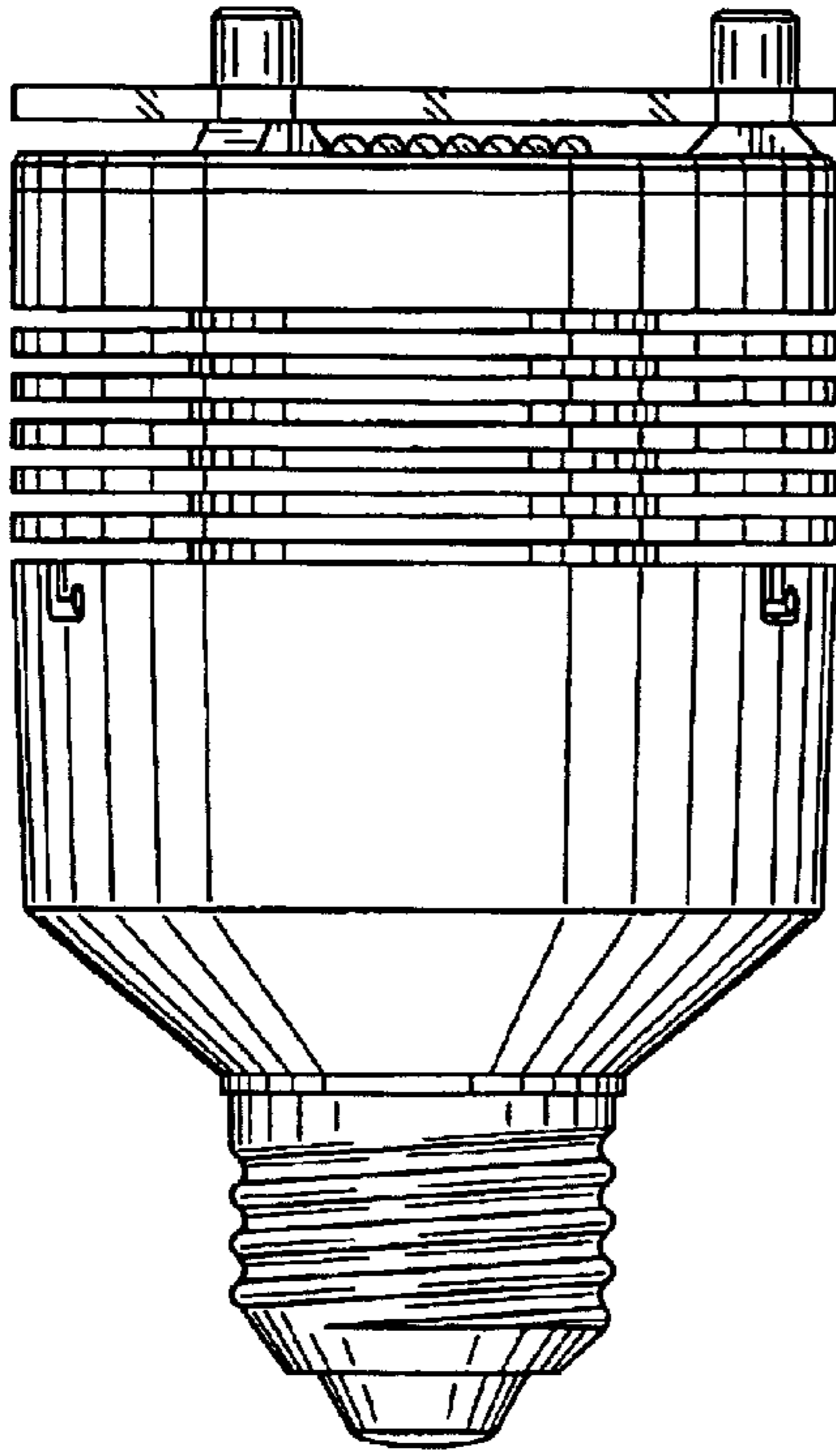

*FIG. 5*

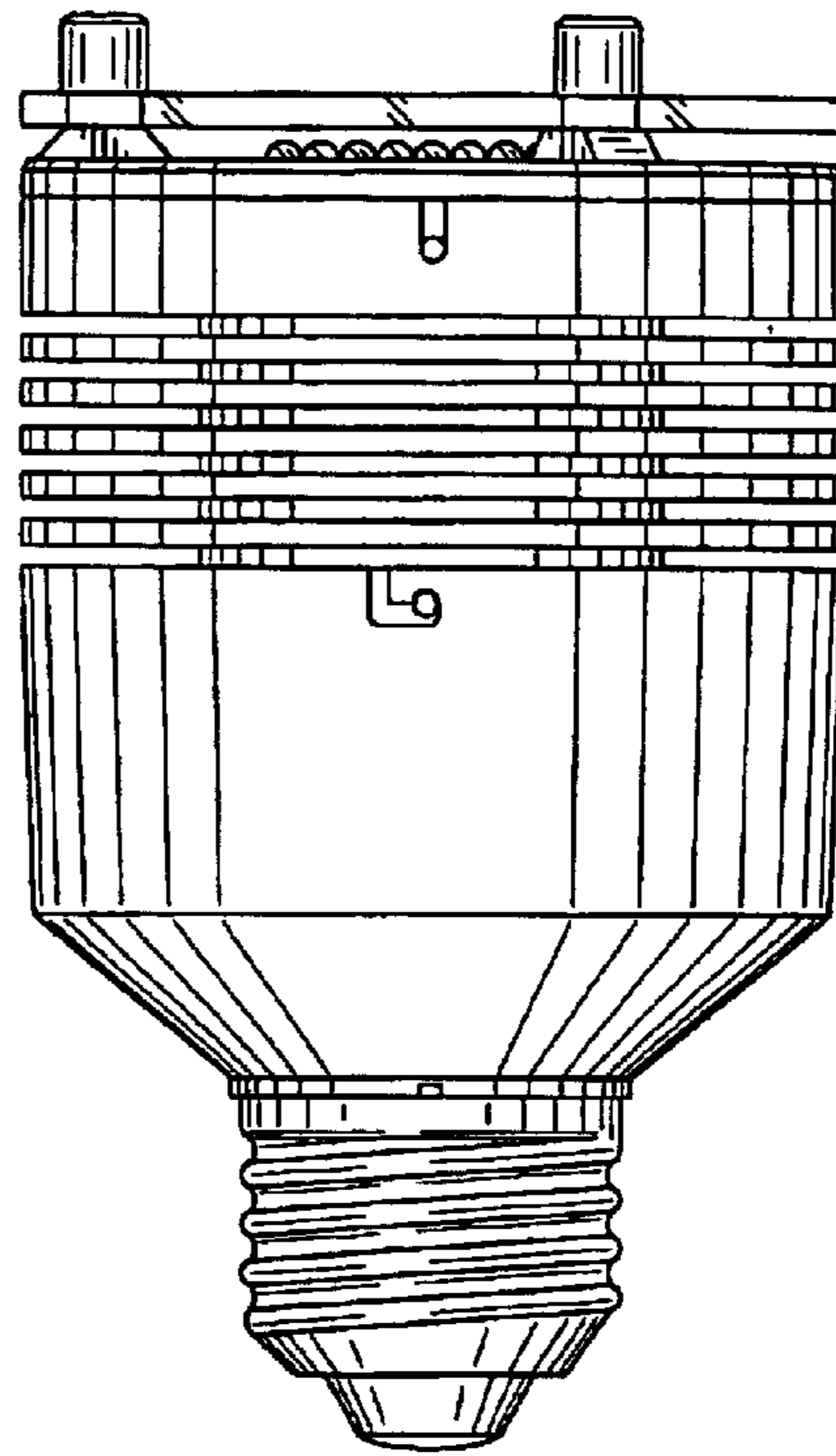

*FIG. 6*

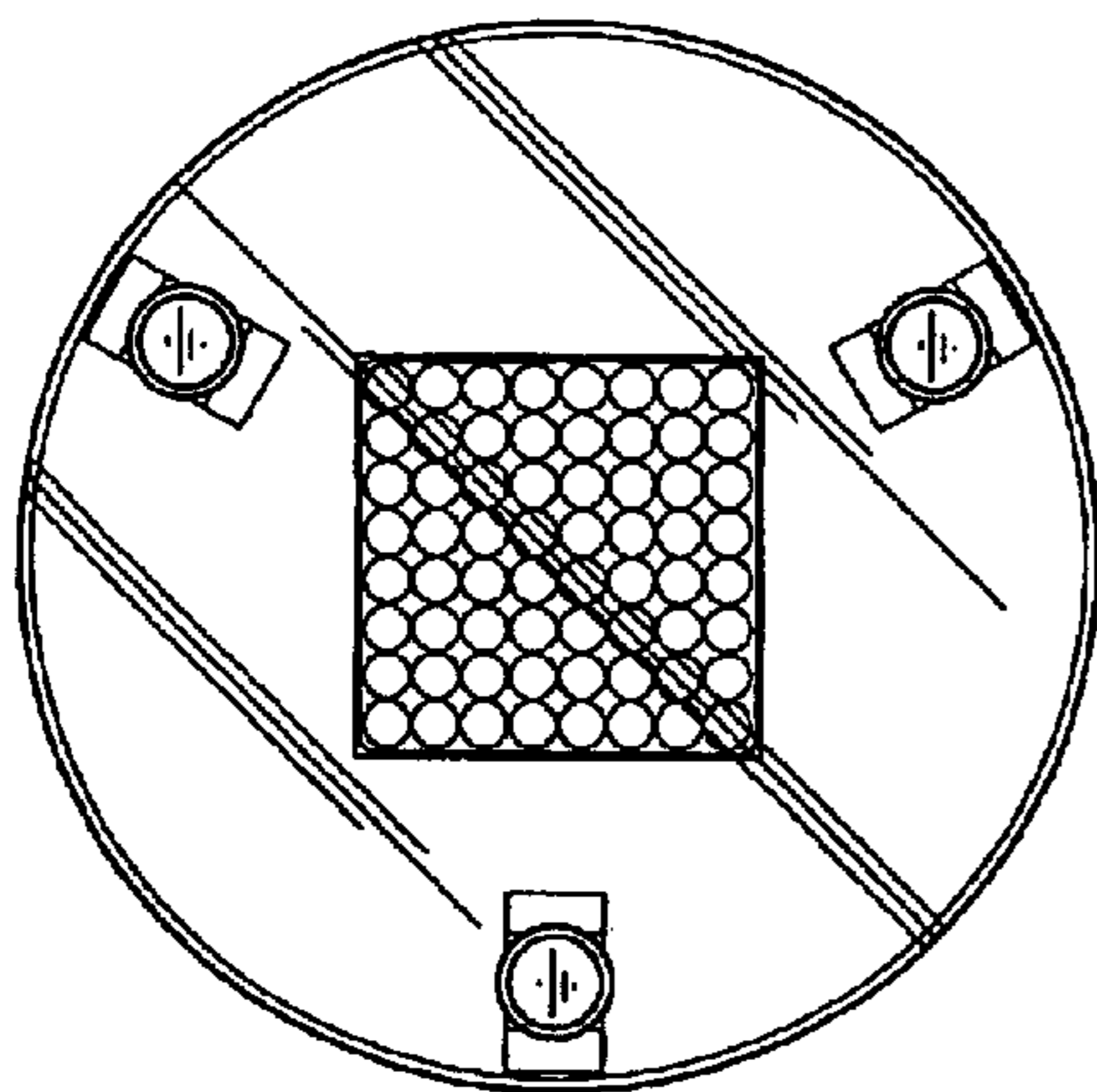

*FIG. 7*

