

US00D494686S1

(12) **United States Design Patent**  
**Mignone**

(10) **Patent No.:** **US D494,686 S**

(45) **Date of Patent:** **\*\* Aug. 17, 2004**

(54) **SET OF POOL COPING BRICKS**

(76) **Inventor:** **Mirta S. Mignone**, 2032 Talwood La.,  
Port St. Lucie, FL (US) 34952

(\*\*) **Term:** **14 Years**

(21) **Appl. No.:** **29/190,736**

(22) **Filed:** **Sep. 25, 2003**

(51) **LOC (7) Cl.** ..... **25-02**

(52) **U.S. Cl.** ..... **D25/113**

(58) **Field of Search** ..... D25/112-116,  
D25/118, 2; D21/484-486, 493, 500; 405/19-20,  
42; 52/105

(56) **References Cited**

**U.S. PATENT DOCUMENTS**

4,189,887	A	*	2/1980	Gallant et al.	.....	D25/2
D403,080	S	*	12/1998	Mignone, Jr.	.....	D25/2
D426,895	S	*	6/2000	Mignone	.....	D25/2
D461,010	S	*	7/2002	Brito	.....	D25/113

\* cited by examiner

*Primary Examiner*—Robert A. Delehanty

(74) *Attorney, Agent, or Firm*—Robert M. Downey, PA

(57) **CLAIM**

The ornamental design for set of pool coping bricks, as shown and described.

**DESCRIPTION**

FIG. 1 is a front, top perspective view of the first one of a set of pool coping bricks showing my new design;

FIG. 2 is a front, top perspective view of the second one of a set of pool coping bricks showing my new design;

FIG. 3 is a front elevational view of the set of pool coping bricks of FIG. 1;

FIG. 4 is a right side elevational view of the set of pool coping bricks of FIG. 1, the opposite left side elevation view being identical;

FIG. 5 is a rear elevational view of the set of pool coping bricks of FIG. 1;

FIG. 6 is a front elevational view of the set of pool coping bricks of FIG. 2;

FIG. 7 is a right side elevational view of the set of pool coping bricks of FIG. 2, the opposite left side elevational view being identical;

FIG. 8 is a rear elevational view of the set of pool coping bricks of FIG. 2;

FIG. 9 is a top plan view of the set of pool coping bricks of FIG. 1;

FIG. 10 is a bottom plan view of the set of pool coping bricks of FIG. 1;

FIG. 11 is a top plan view of the set of pool coping bricks of FIG. 2; and,

FIG. 12 is a bottom plan view of the set of pool coping bricks of FIG. 2.

**1 Claim, 3 Drawing Sheets**

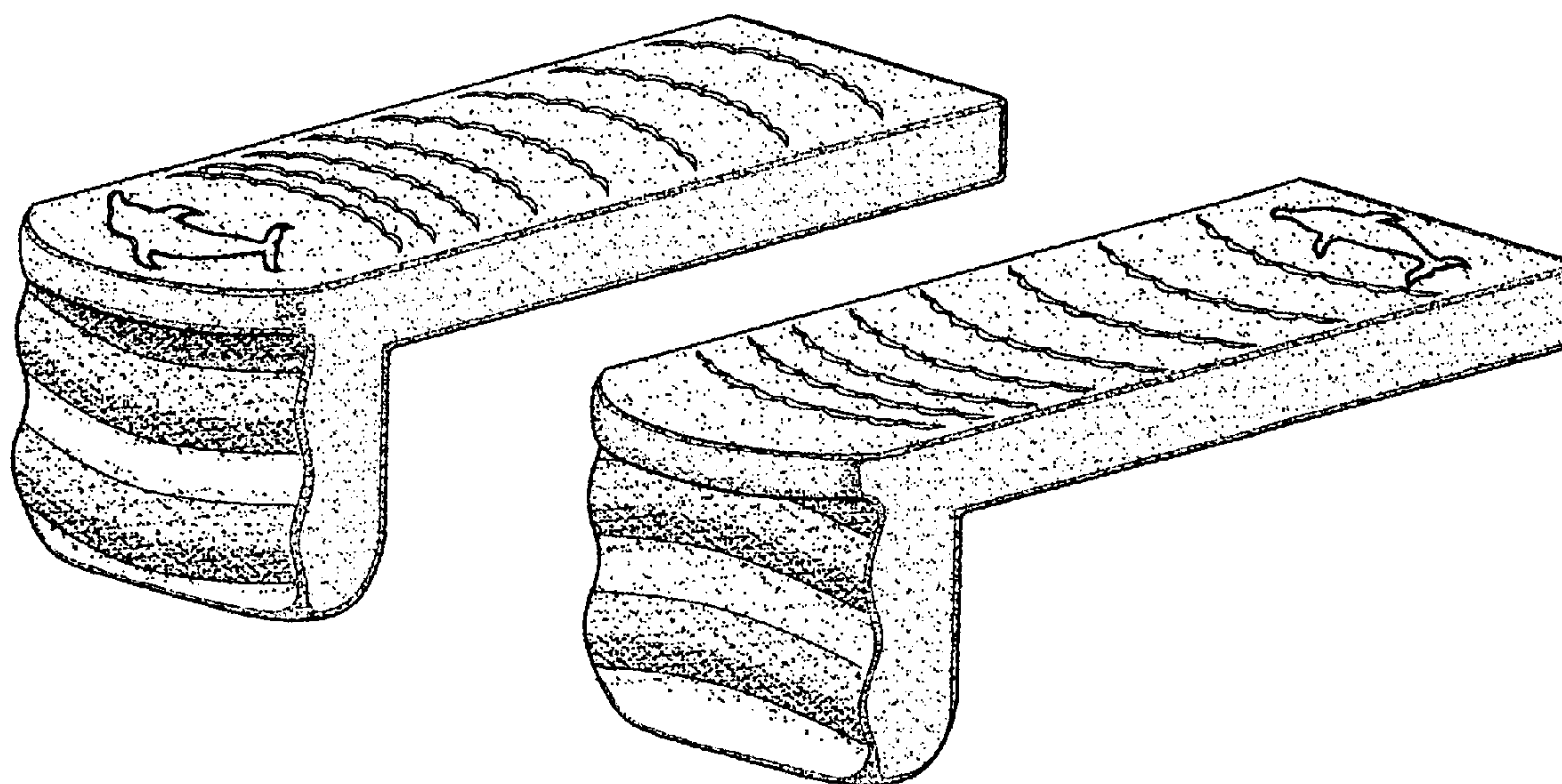

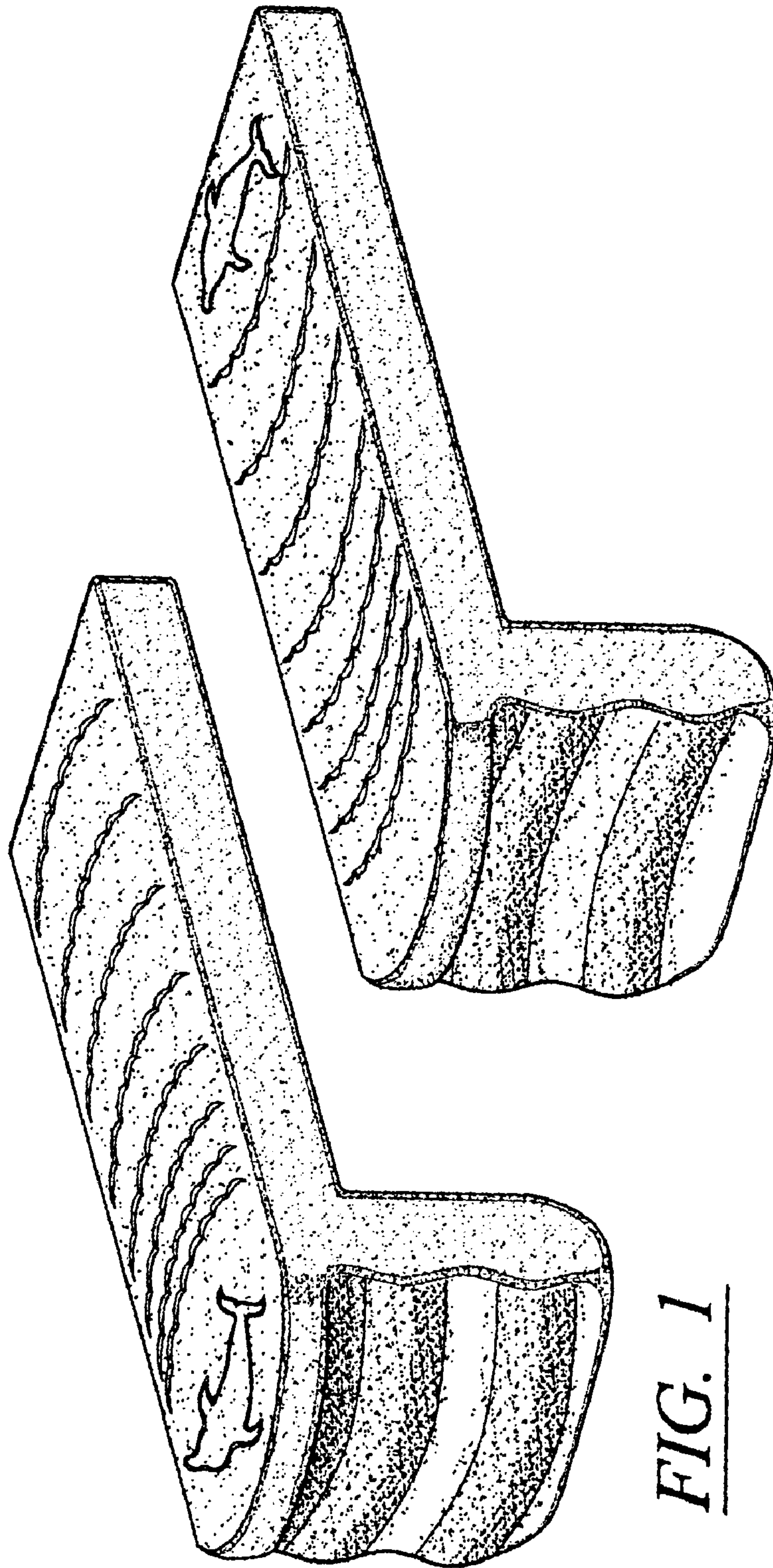

FIG. 1

FIG. 2



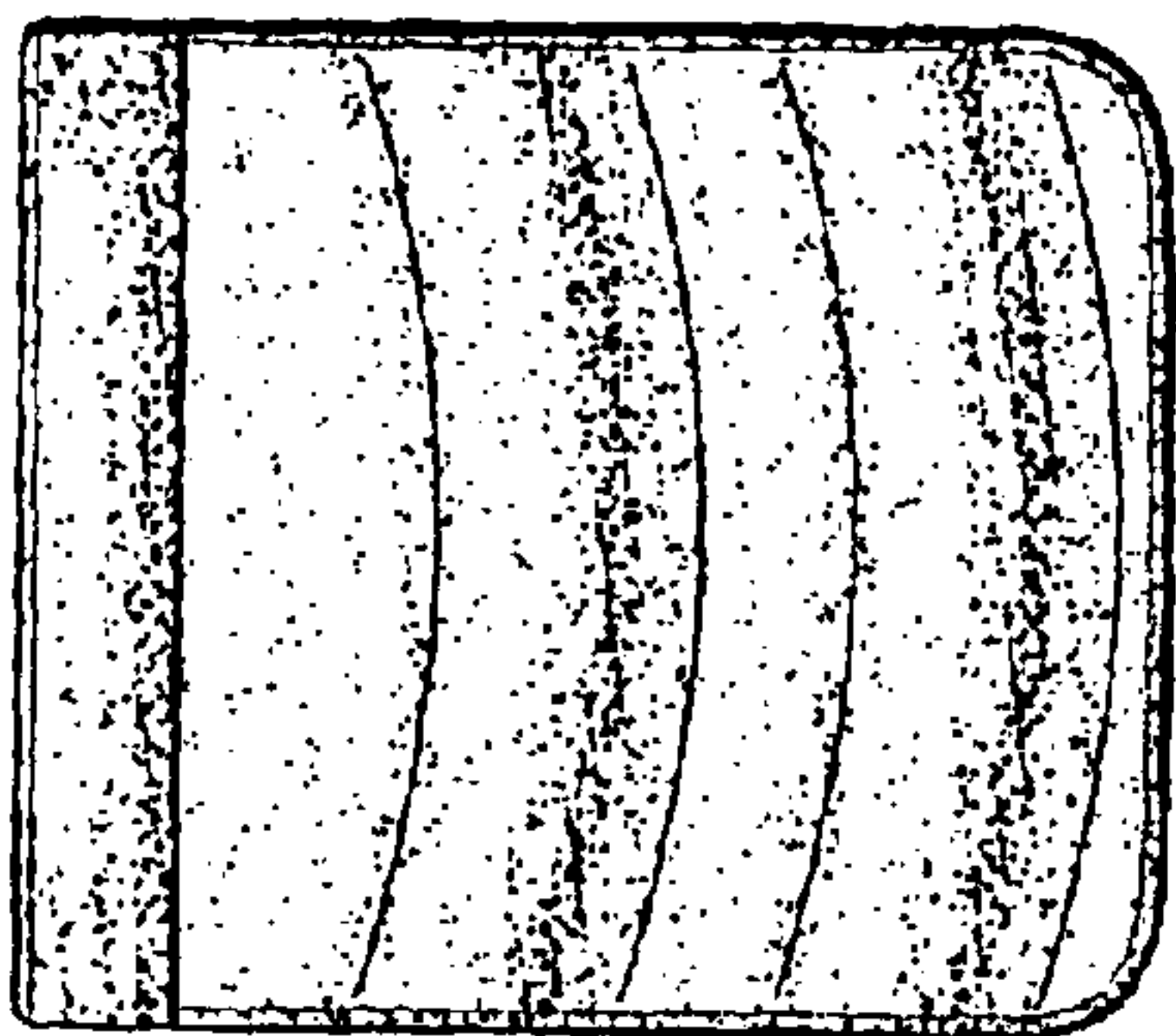

FIG. 3

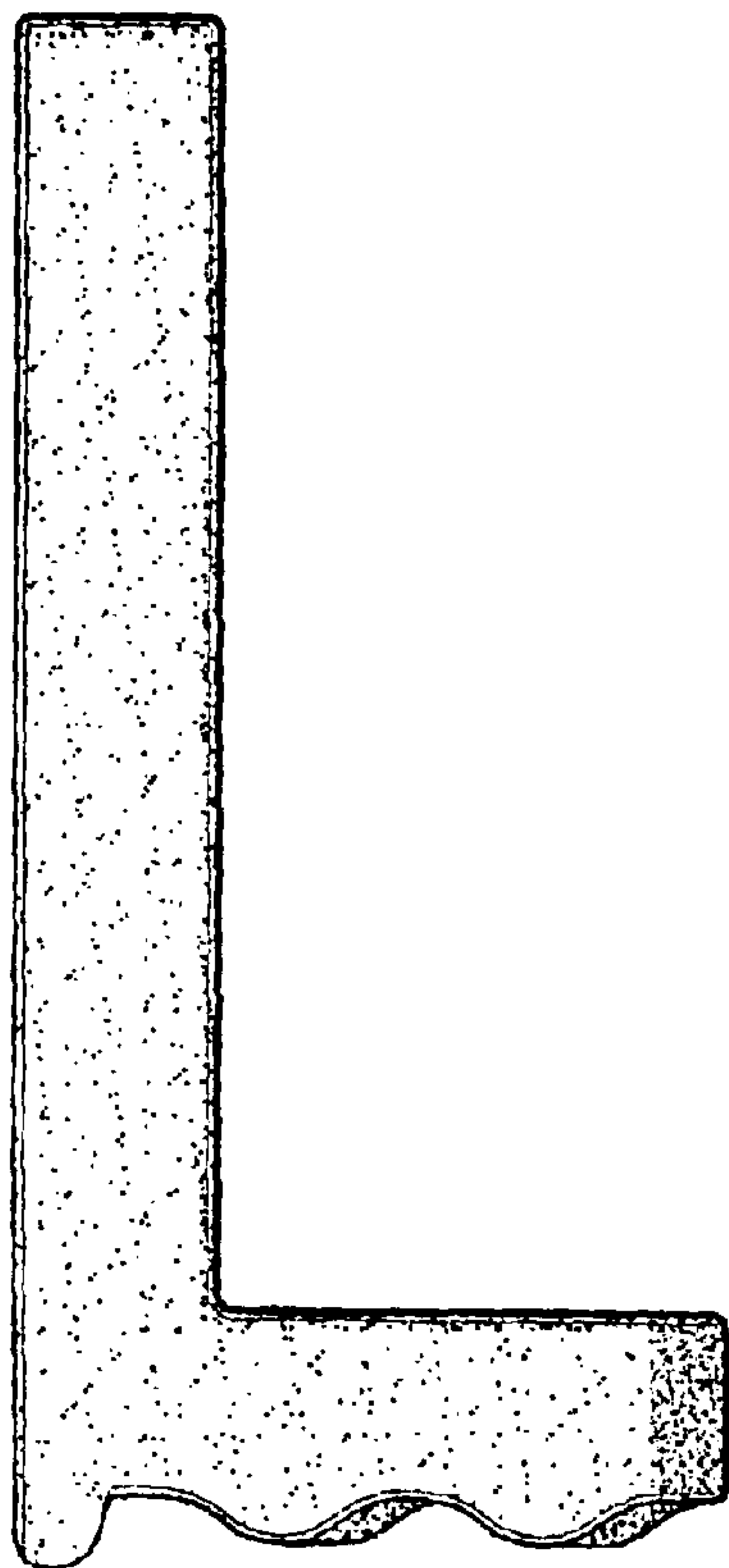

FIG. 4

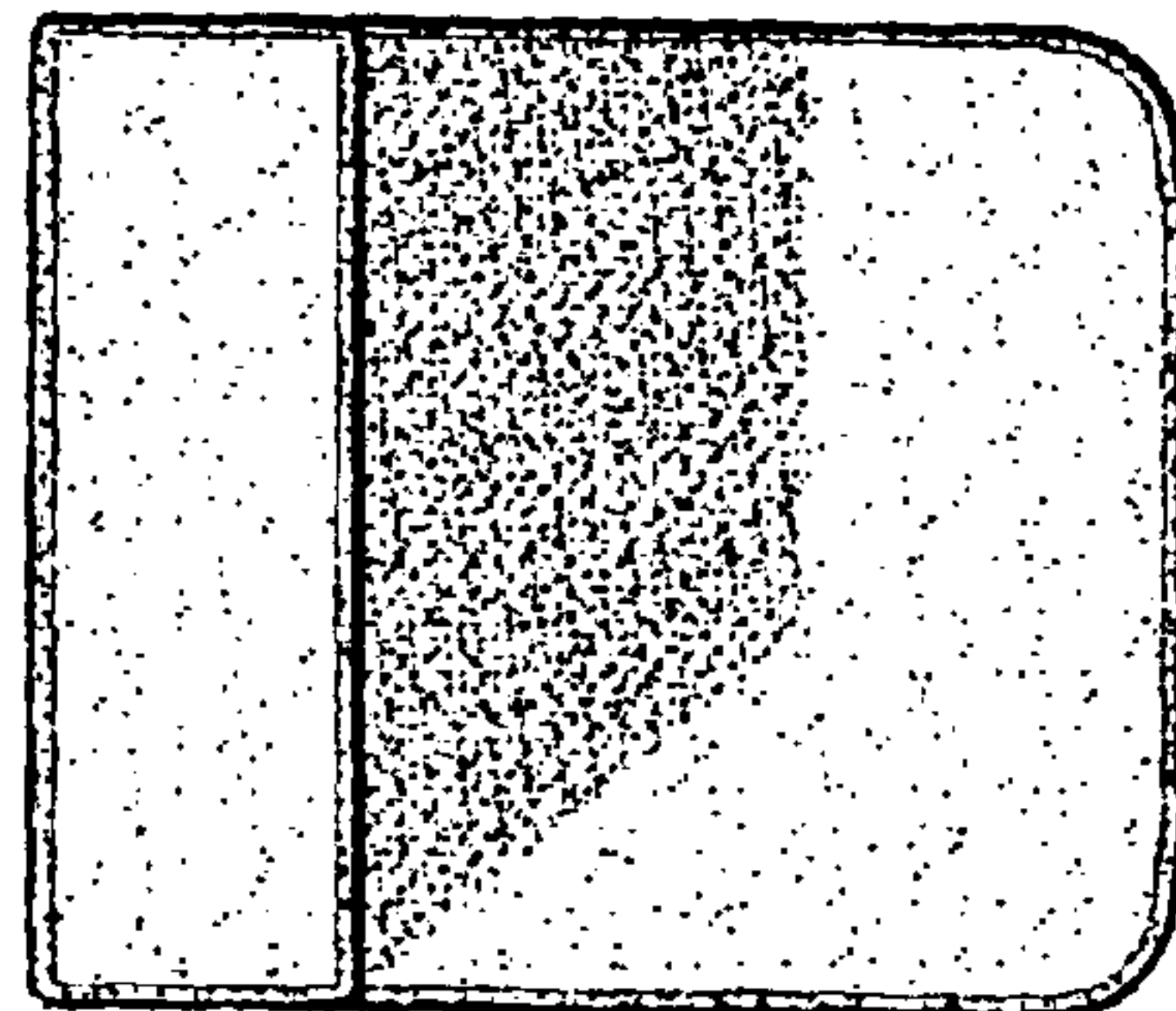

FIG. 5

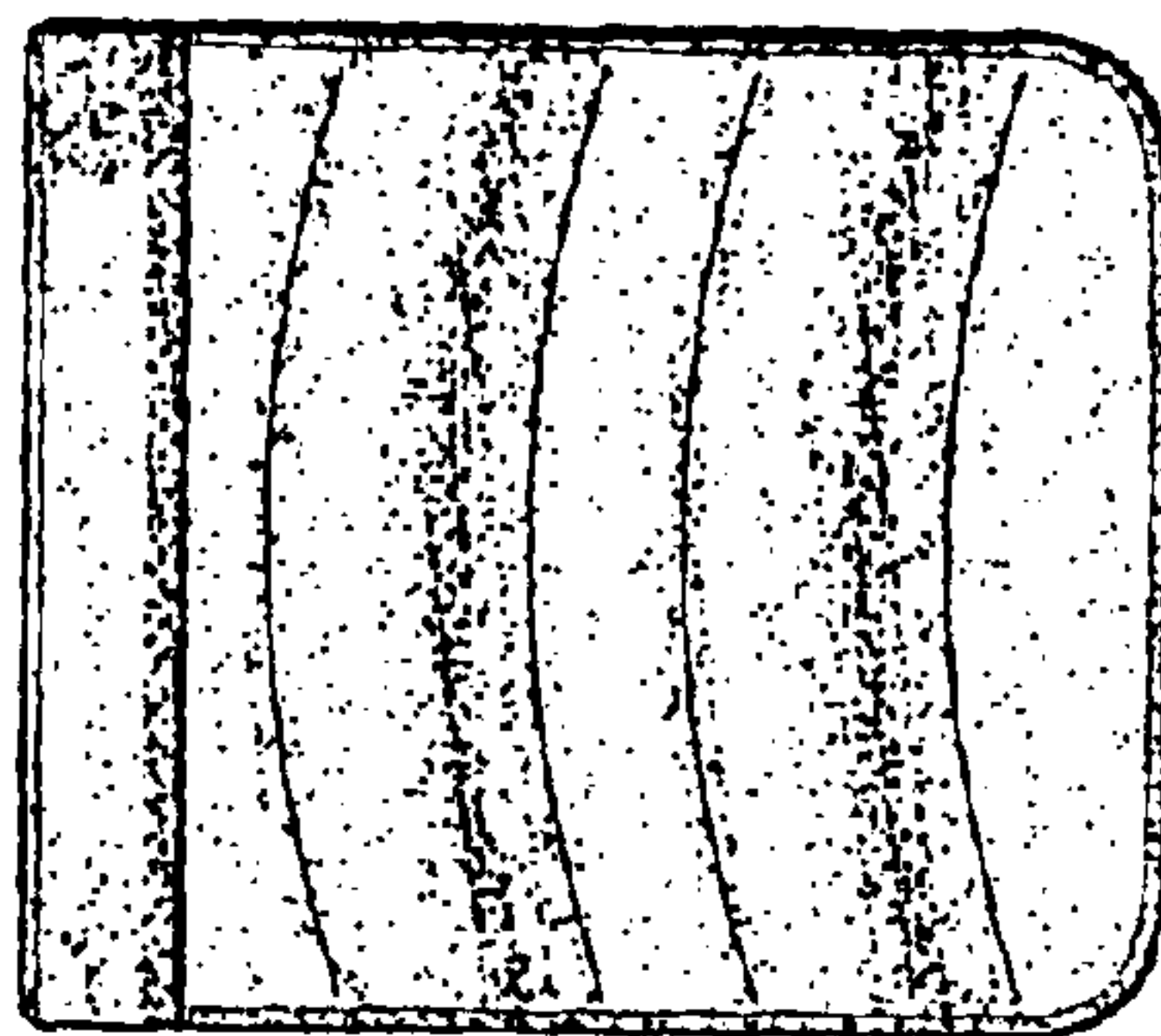

FIG. 6

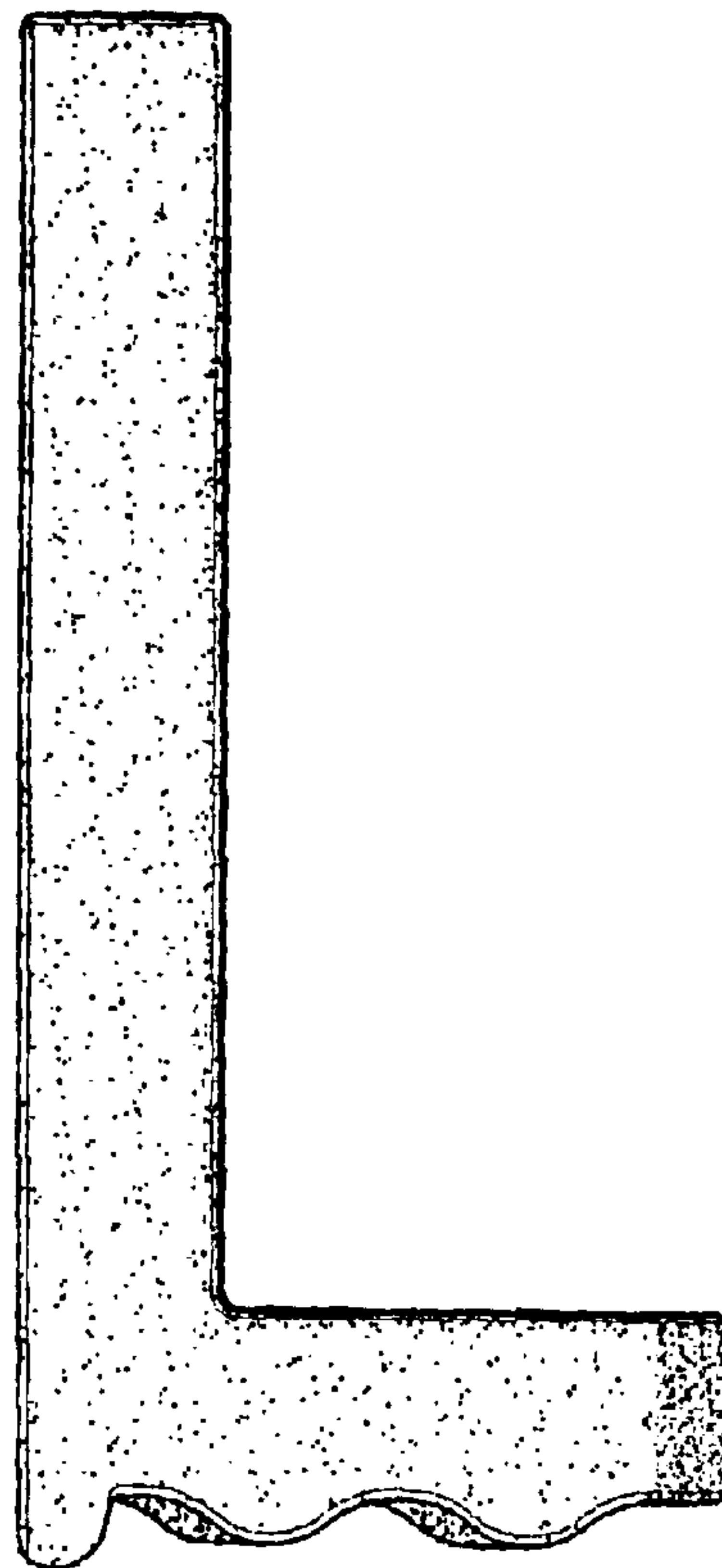

FIG. 7

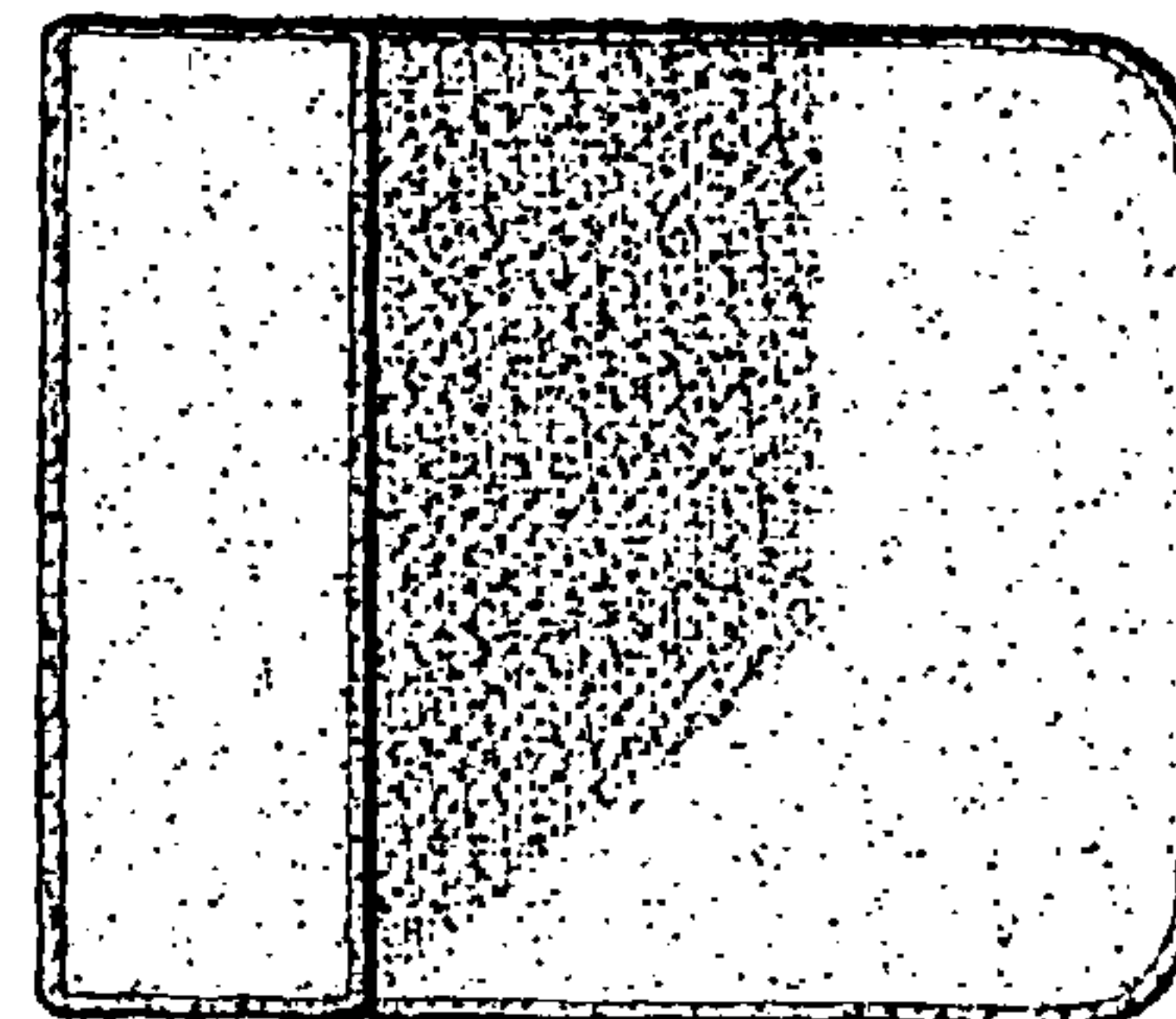

FIG. 8

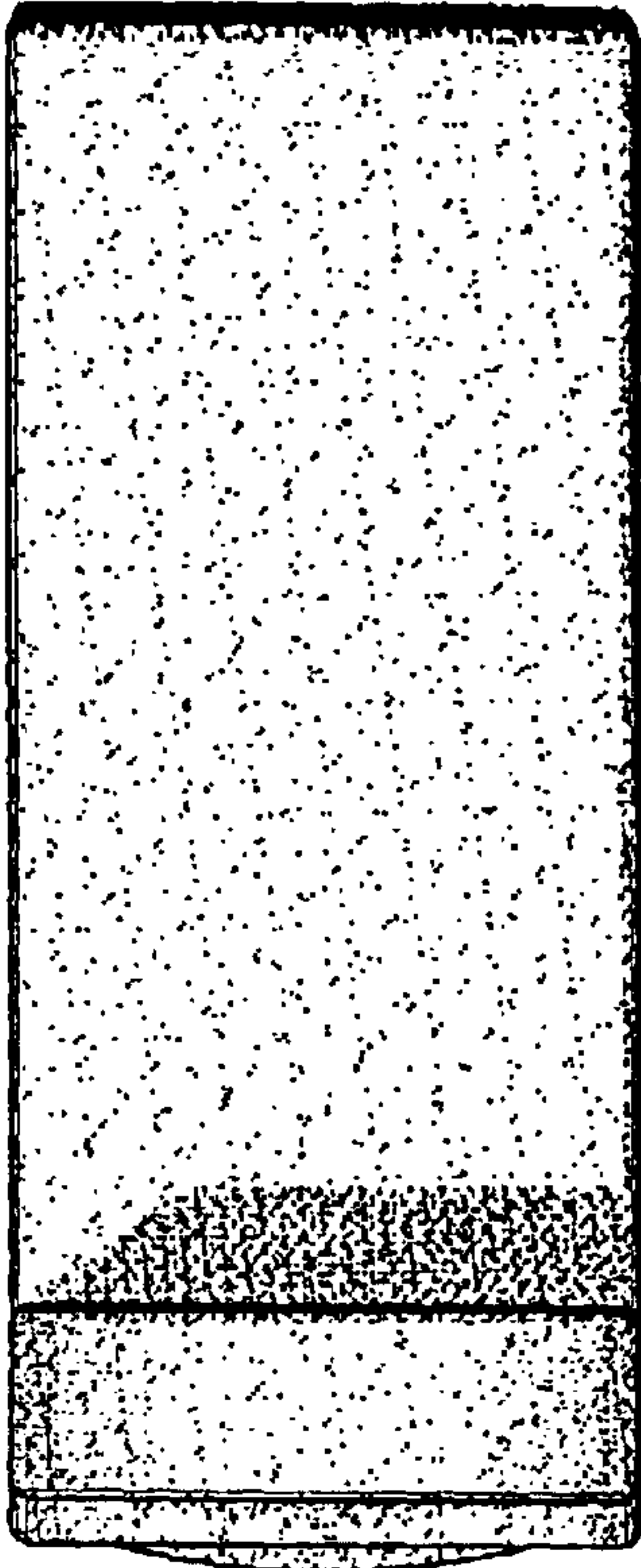

FIG. 10

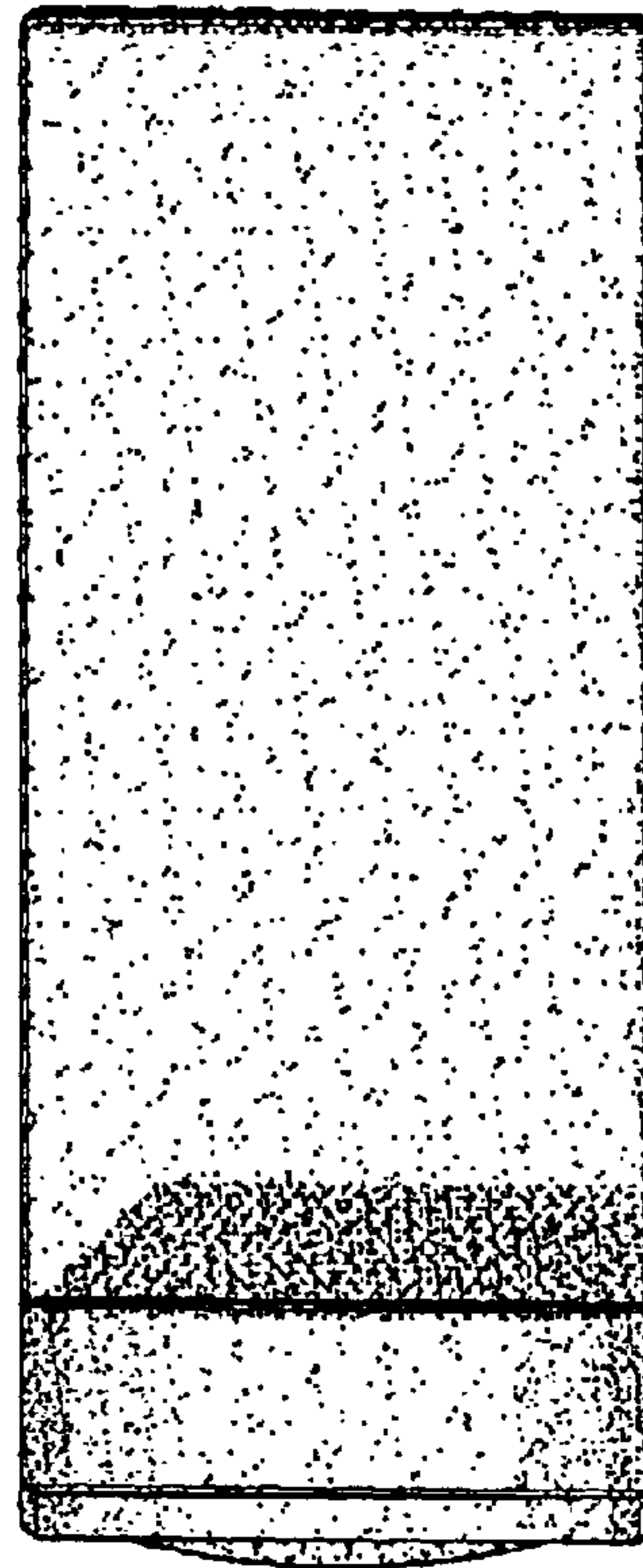

FIG. 12

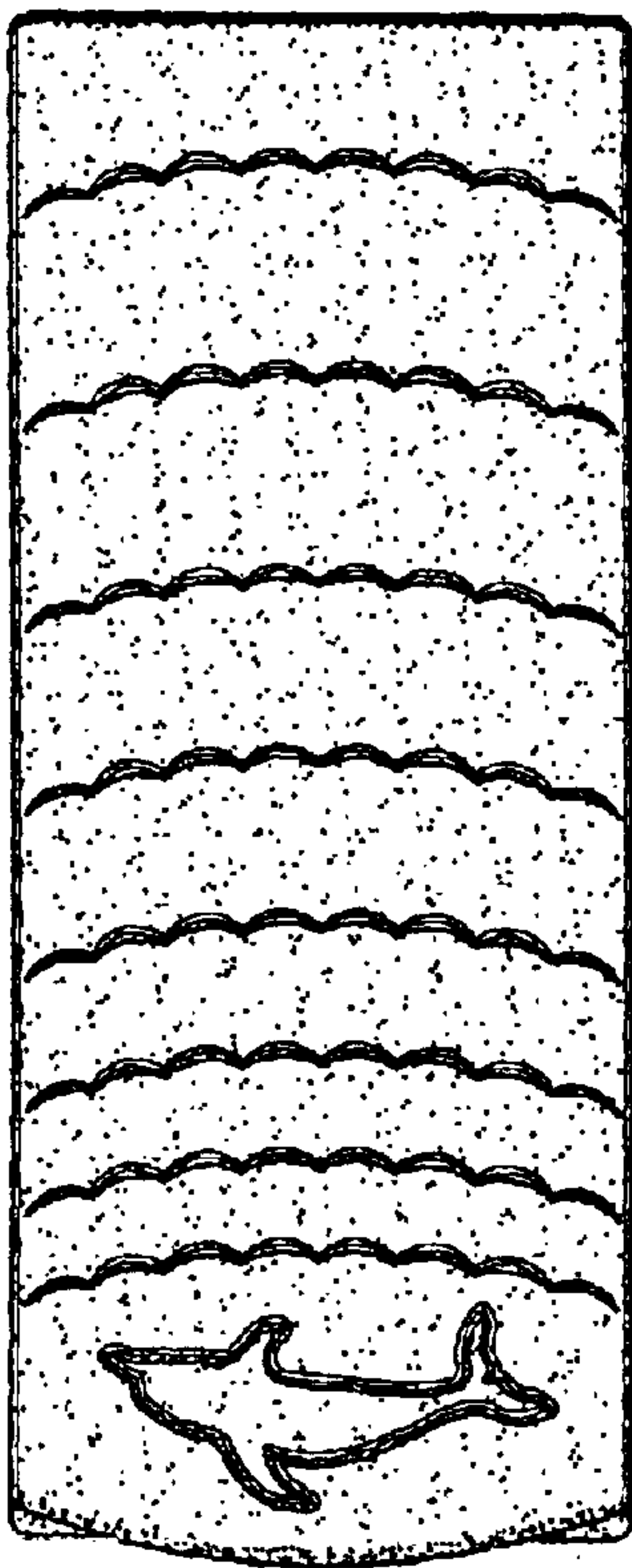

FIG. 9

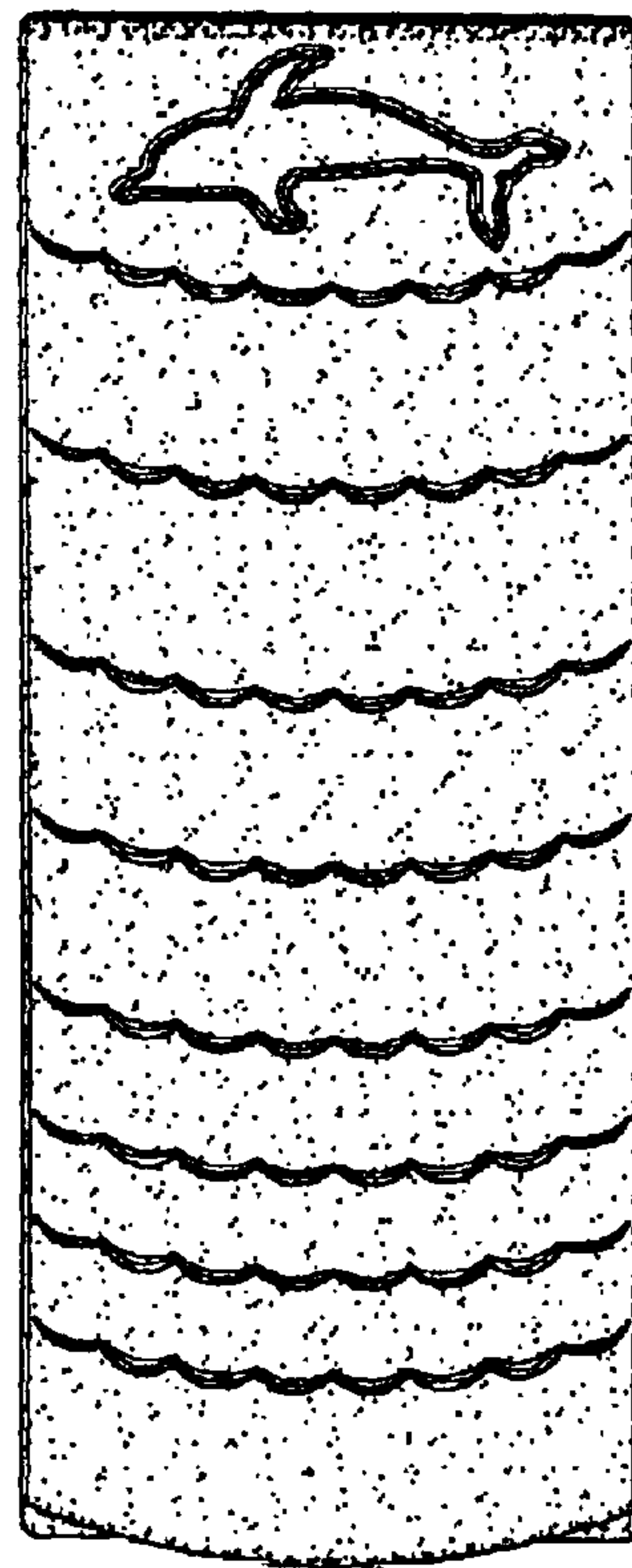

FIG. 11