

US00D494648S1

(12) **United States Design Patent** (10) **Patent No.:** **US D494,648 S**  
**Schweigert et al.** (45) **Date of Patent:** **\*\* Aug. 17, 2004**

(54) **GOLF IRON HEAD**

D481,775 S \* 11/2003 Best ..... D21/759

(75) Inventors: **Bradley D. Schweigert**, Glendale, AZ (US); **Michael R. Nicolette**, Scottsdale, AZ (US); **John A. Solheim**, Phoenix, AZ (US)

\* cited by examiner

*Primary Examiner*—Mitchell Siegel  
(74) *Attorney, Agent, or Firm*—Darrell F. Marquette

(73) Assignee: **Karsten Manufacturing Corporation**, Phoenix, AZ (US)

(57) **CLAIM**

We claim the ornamental design for a golf iron head, as shown and described.

(\*\*) Term: **14 Years**

**DESCRIPTION**

(21) Appl. No.: **29/185,283**

(22) Filed: **Jun. 24, 2003**

**Related U.S. Application Data**

(63) Continuation-in-part of application No. 29/183,512, filed on Jun. 11, 2003.

(51) **LOC (7) Cl.** ..... **21-02**

(52) **U.S. Cl.** ..... **D21/747**

(58) **Field of Search** ..... D21/747-751;  
473/324-331, 350

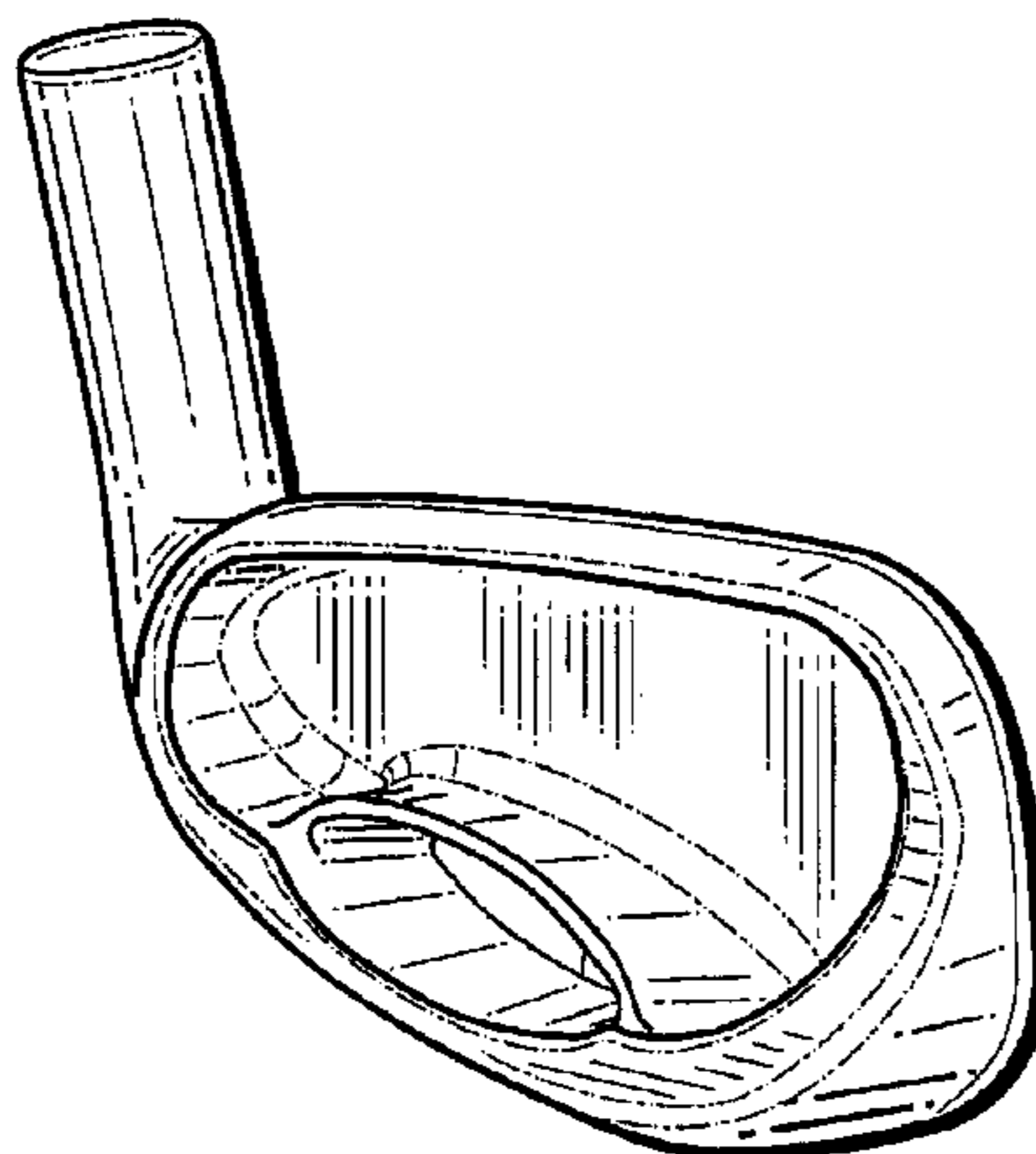
FIG. 1 is a perspective view of a golf iron head with a low loft angle such as a 2-iron showing our new design; FIG. 2 is a toe end view of the golf iron head of FIG. 1; FIG. 3 is a heel end view of the golf iron head of FIG. 1; FIG. 4 is a top view of the golf iron head of FIG. 1; FIG. 5 is a bottom view of the golf iron head of FIG. 1; FIG. 6 is a front elevational view of the golf iron head of FIG. 1; FIG. 7 is a rear elevational view of the golf iron head of FIG. 1; FIG. 8 is a perspective view of a golf iron head with a medium loft angle such as a 6-iron showing our new design; FIG. 9 is a toe end view of the golf iron head of FIG. 8; FIG. 10 is a heel end view of the golf iron head of FIG. 8; FIG. 11 is a top view of the golf iron head of FIG. 8; FIG. 12 is a bottom view of the golf iron head of FIG. 8; FIG. 13 is a front elevational view of the golf iron head of FIG. 8; FIG. 14 is a rear elevational view of the golf iron head of FIG. 8; FIG. 15 is a perspective view of a golf iron head with a high loft angle such as a wedge showing our new design; FIG. 16 is a toe end view of the golf iron head of FIG. 15; FIG. 17 is a heel end view of the golf iron head of FIG. 15; FIG. 18 is a top view of the golf iron head of FIG. 15; FIG. 19 is a bottom view of the golf iron head of FIG. 15; FIG. 20 is a front elevational view of the golf iron head of FIG. 15; and, FIG. 21 is a rear elevational view of the golf iron head of FIG. 15.

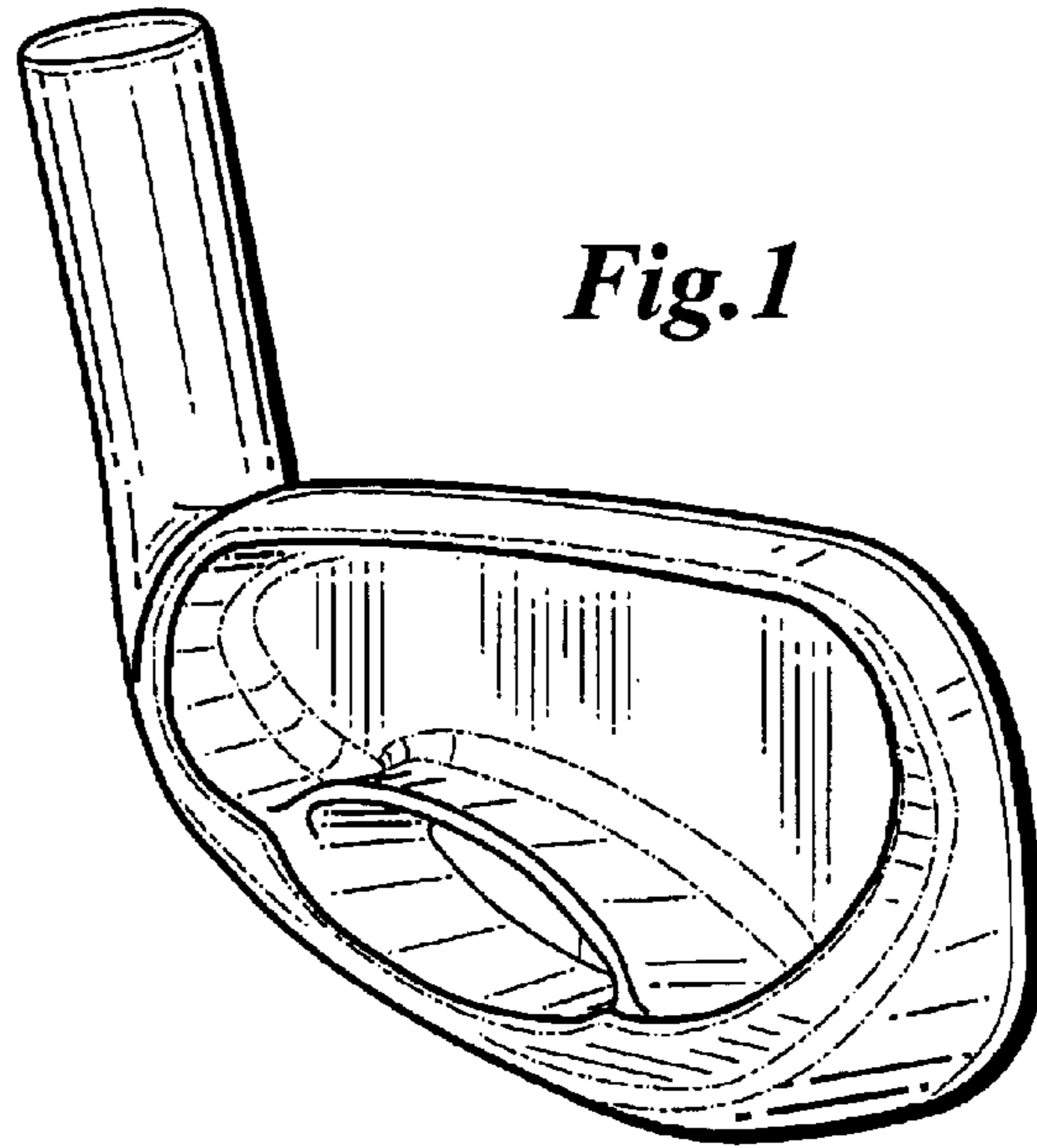
(56) **References Cited**

**U.S. PATENT DOCUMENTS**

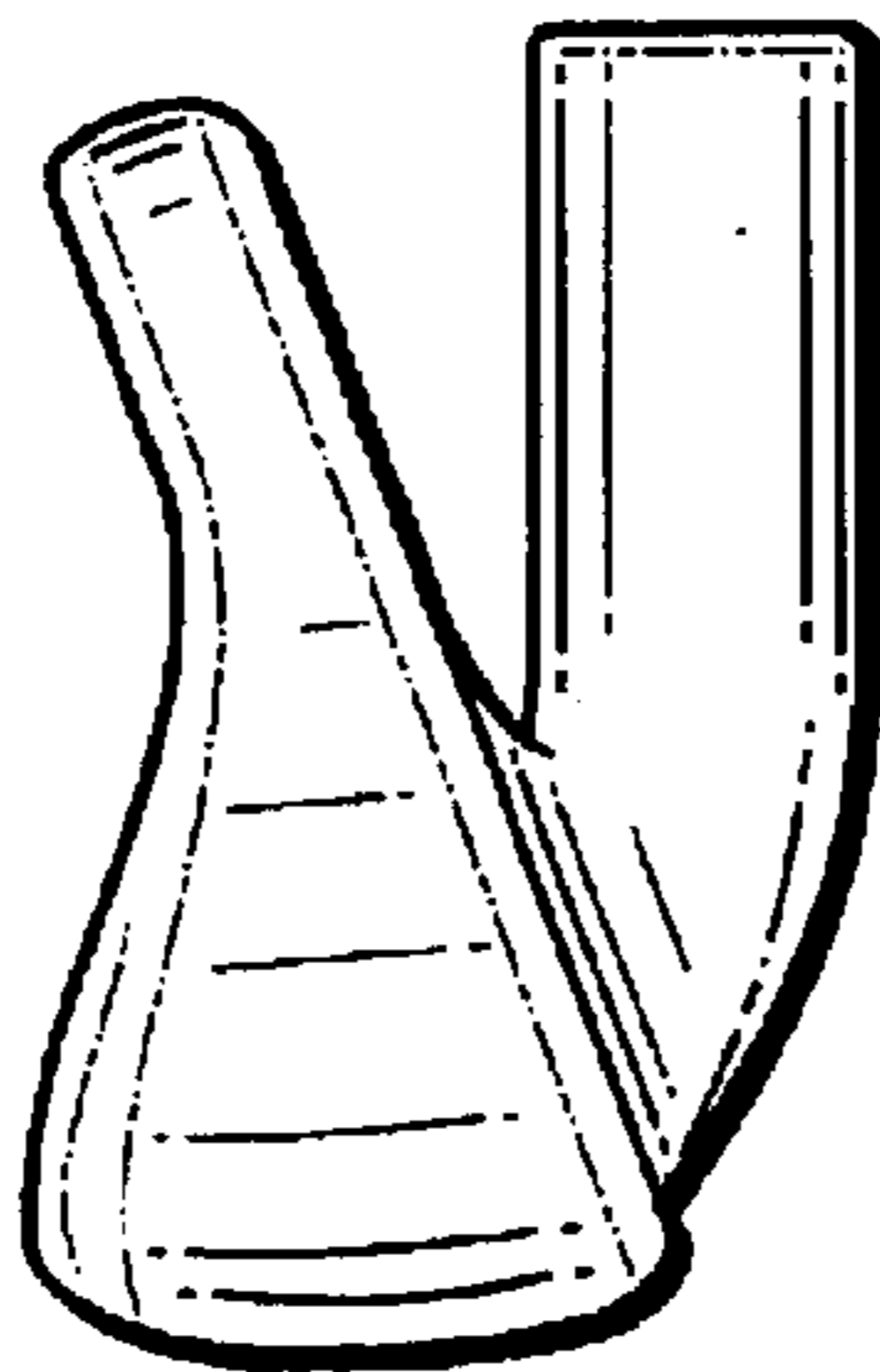
D240,841 S	8/1976	Solheim	
D256,264 S	8/1980	Solheim	
D332,812 S	1/1993	Solheim	
D357,293 S	4/1995	Solheim	
D379,393 S	5/1997	Kubica	
D422,043 S	3/2000	Kubica	
D429,299 S	8/2000	Kubica	
D436,149 S	* 1/2001	Helmstetter et al.	..... D21/748
D442,659 S	5/2001	Kubica	
D443,008 S	* 5/2001	Kubica et al.	..... D21/747
D458,328 S	* 6/2002	Solheim et al.	..... D21/747
D465,253 S	* 11/2002	Best	..... D21/759
D466,960 S	* 12/2002	Imamoto	..... D21/747
D468,787 S	* 1/2003	Oosthuizen	..... D21/747
D469,136 S	* 1/2003	Roberts	..... D21/747
D470,554 S	* 2/2003	Truesdale	..... D21/747
D473,605 S	4/2003	Petersen	
D480,440 S	* 10/2003	Rollinson et al.	..... D21/749

**1 Claim, 6 Drawing Sheets**

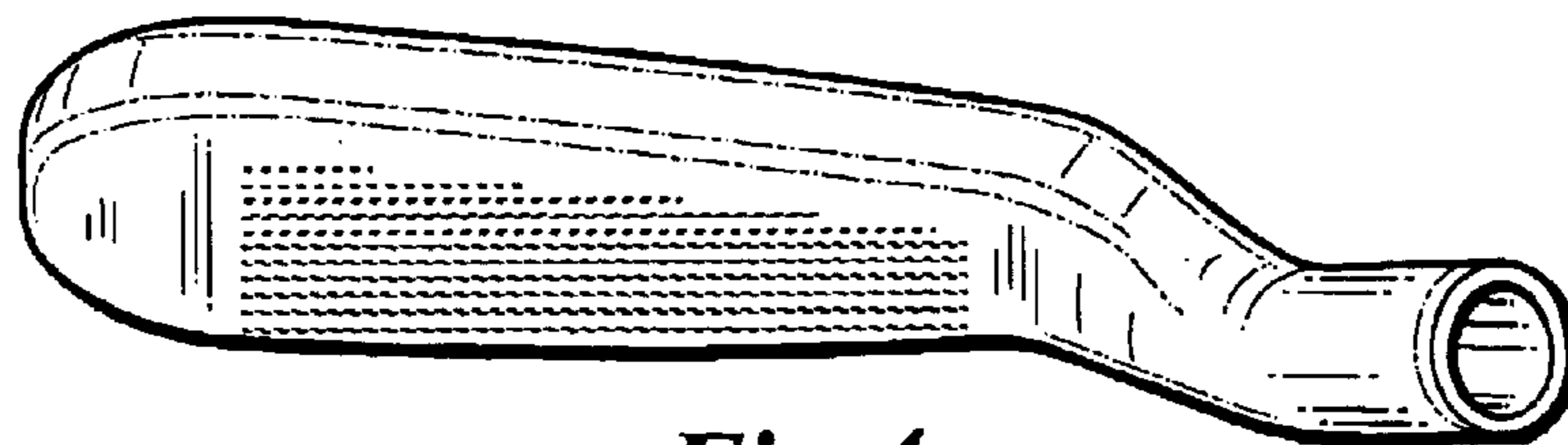
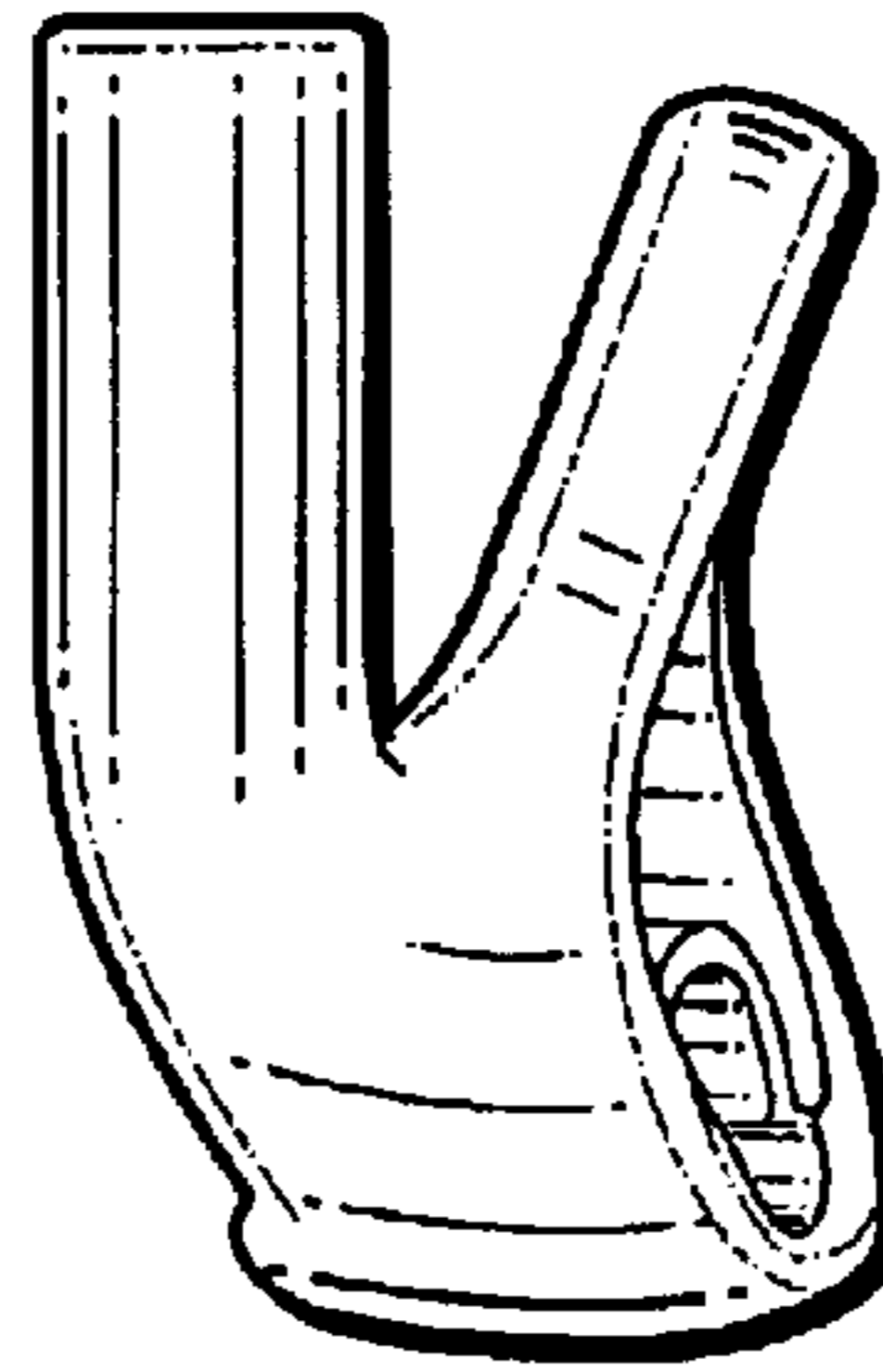




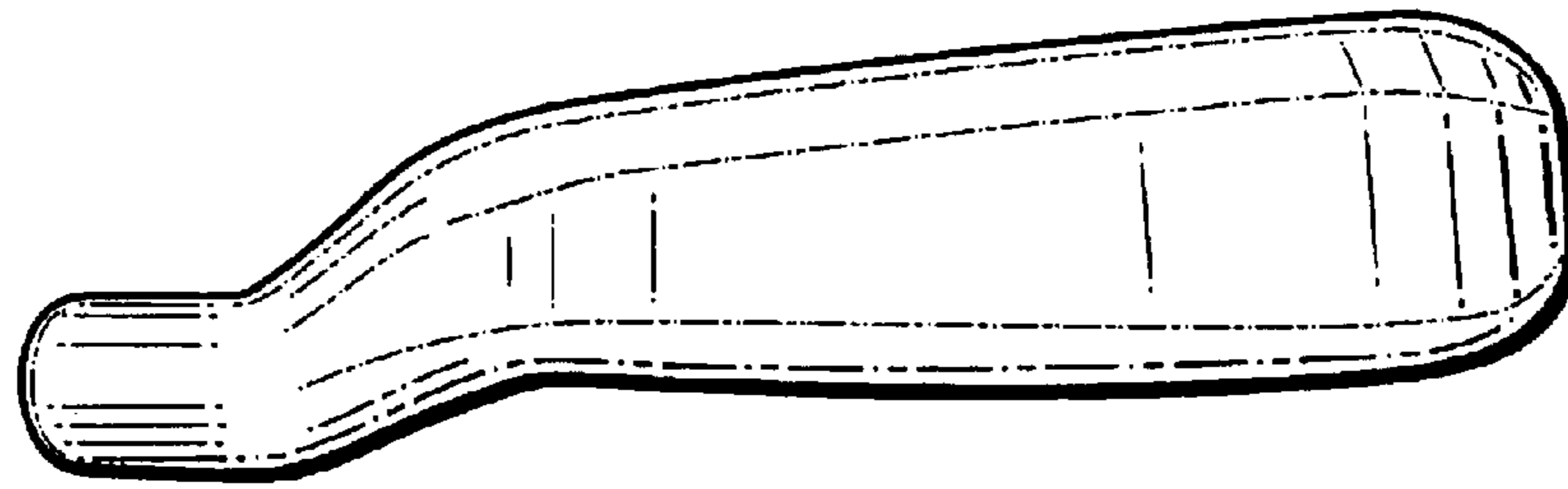
*Fig. 2*



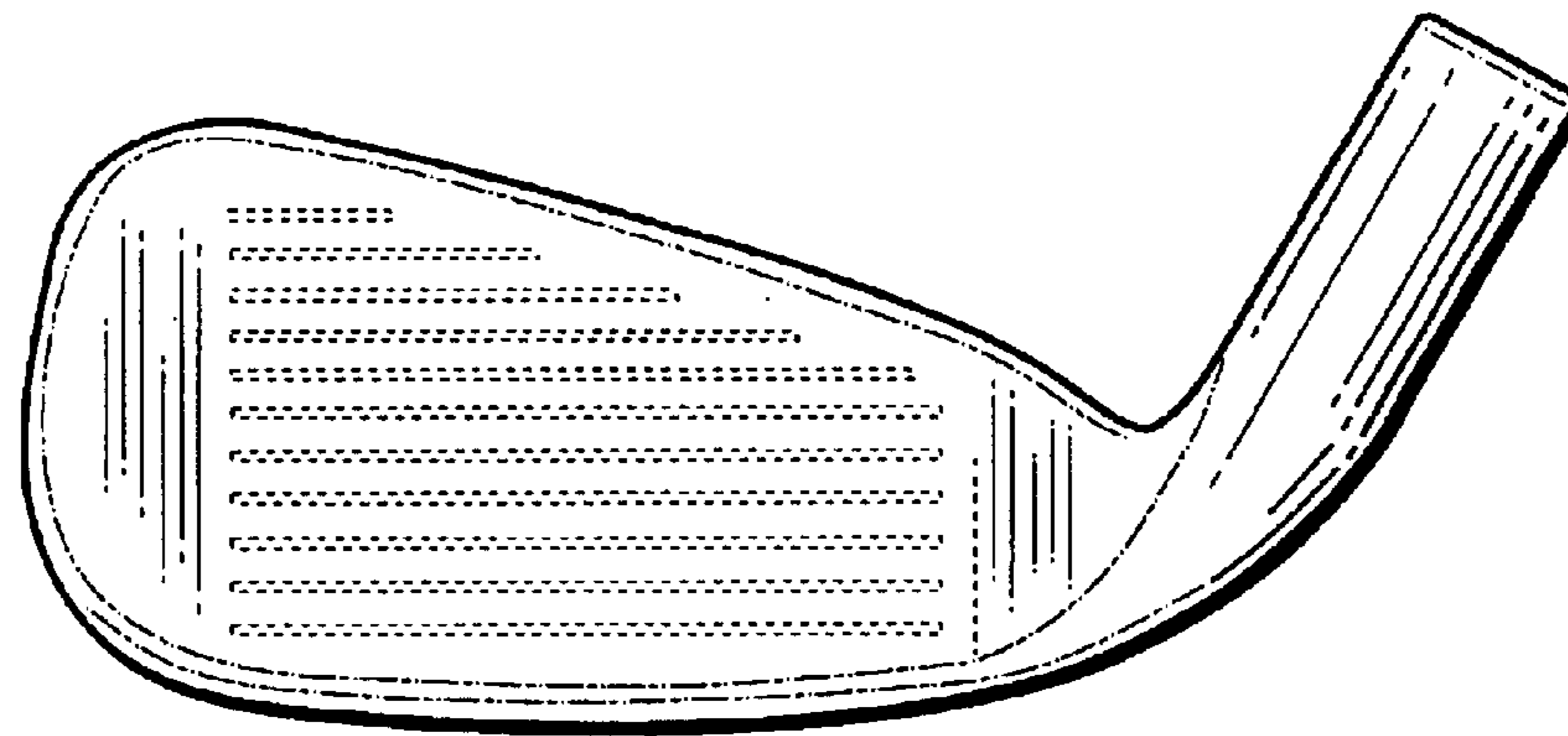
*Fig. 3*



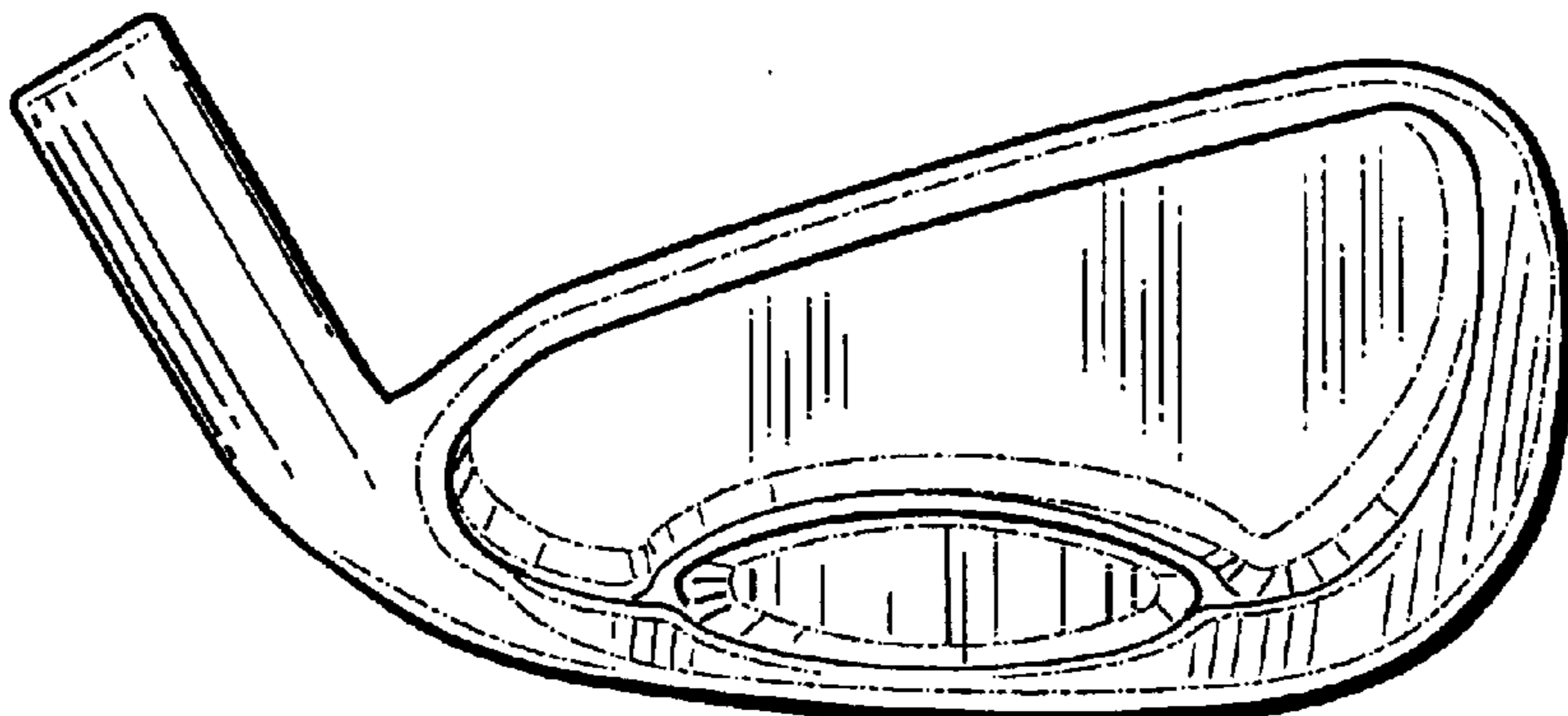
*Fig. 4*



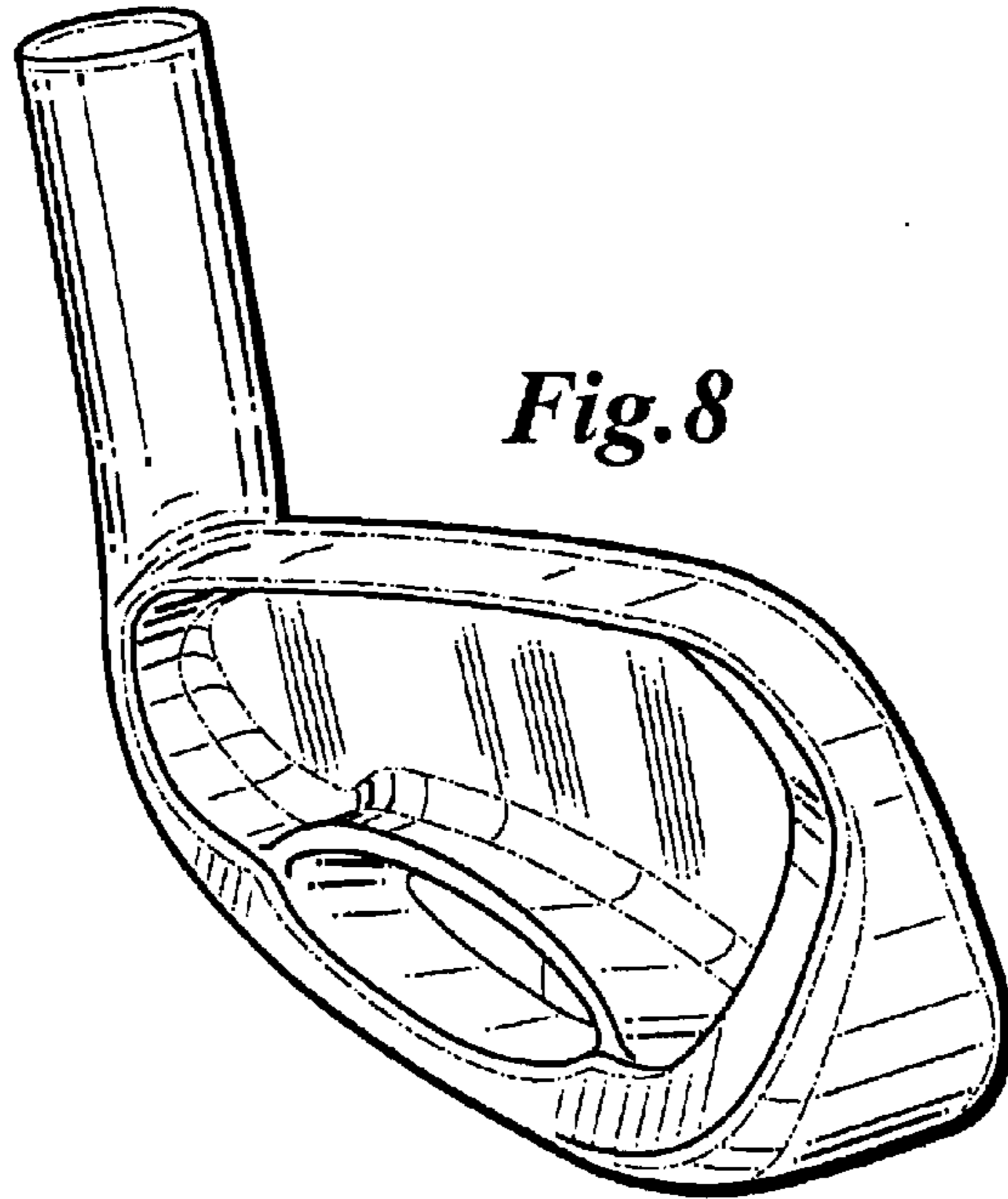
*Fig. 5*



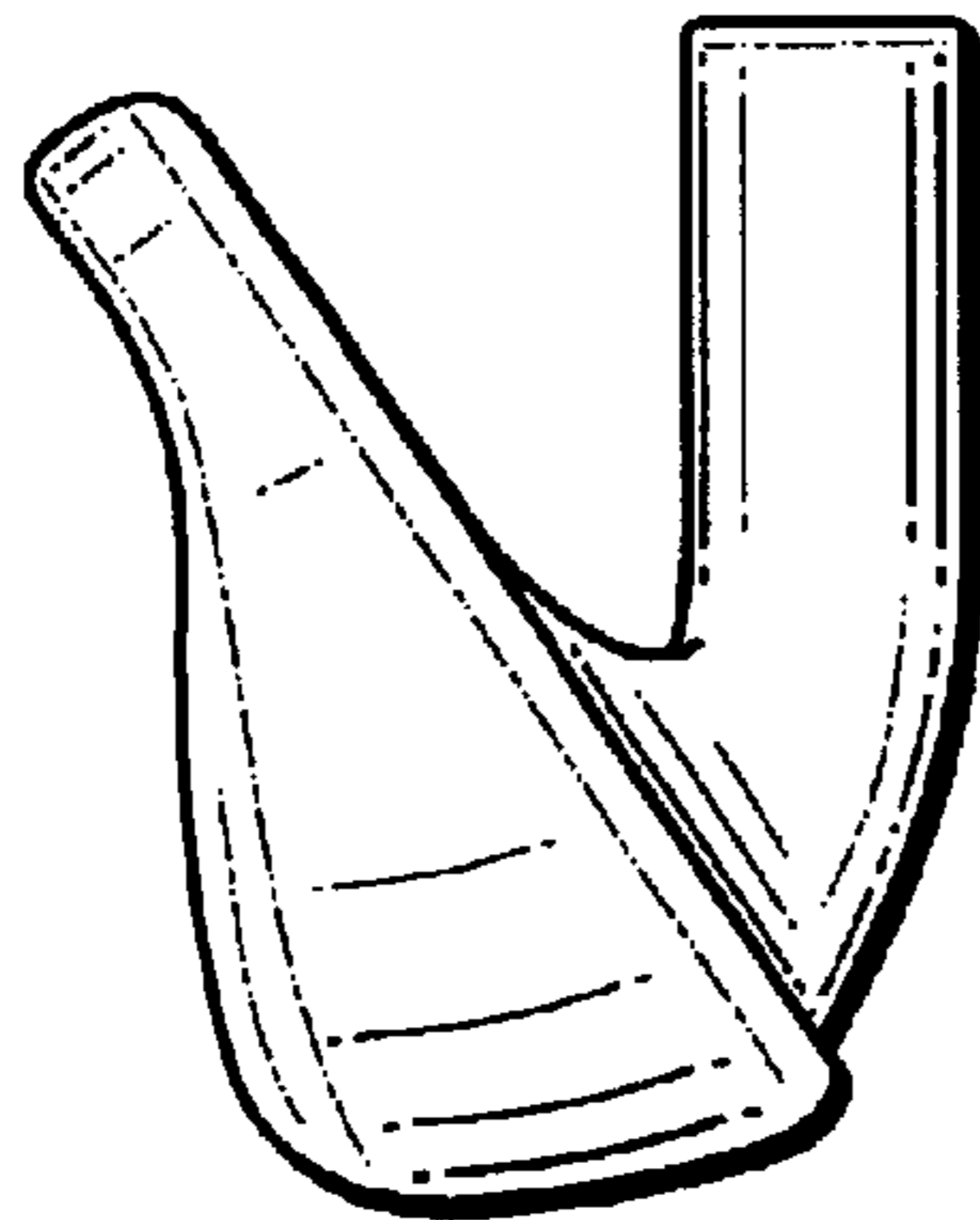
*Fig. 6*



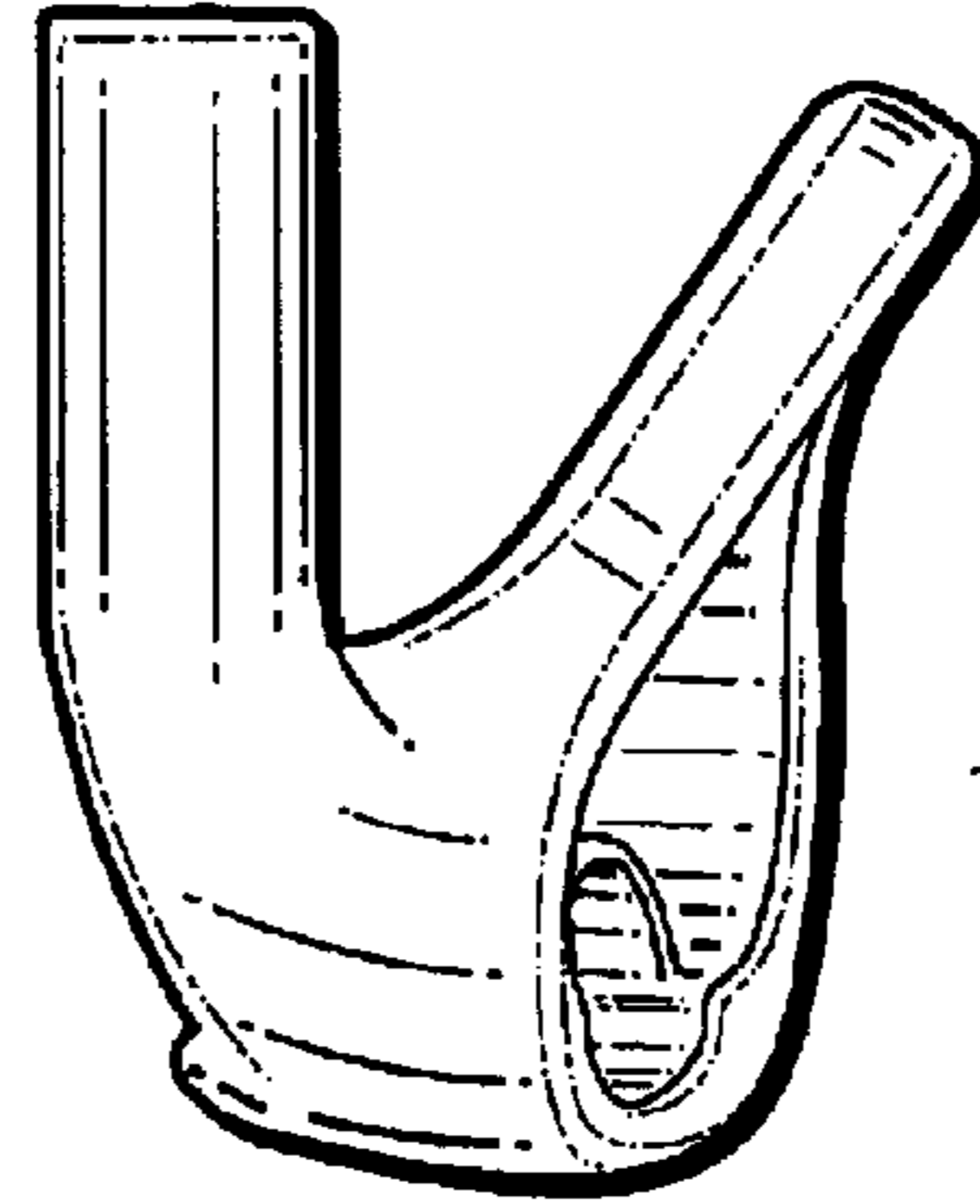
*Fig. 7*



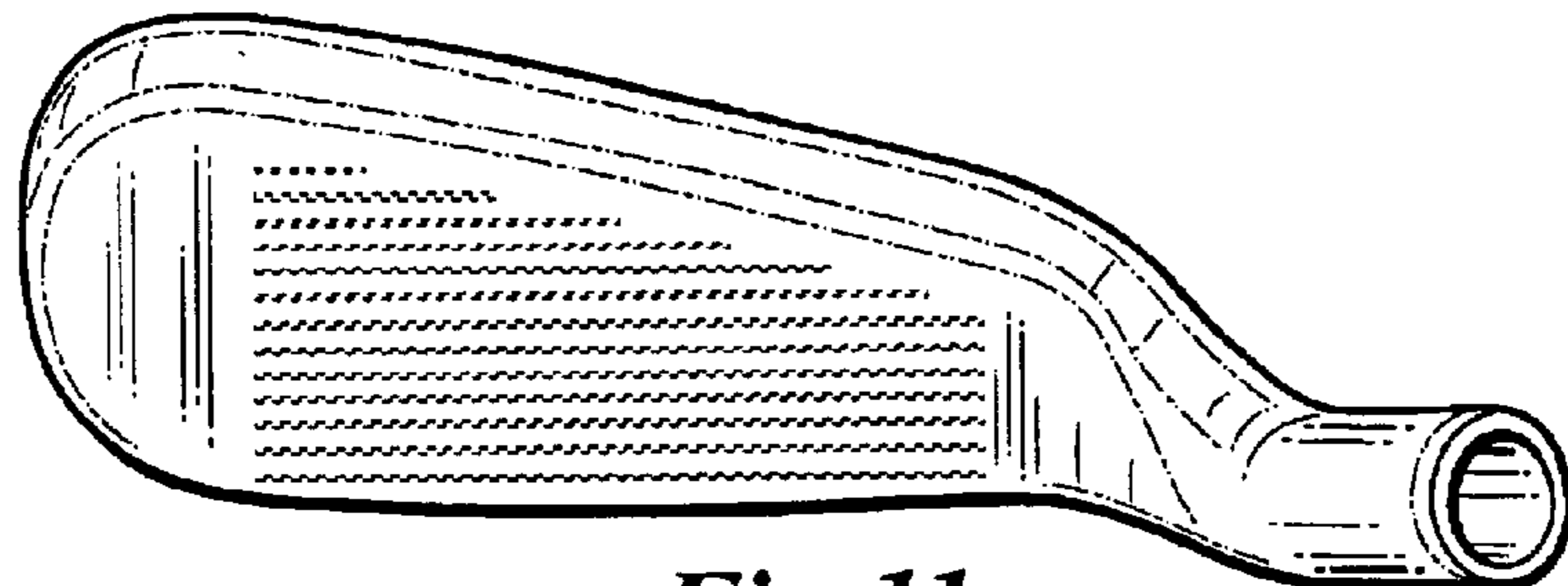
*Fig. 8*



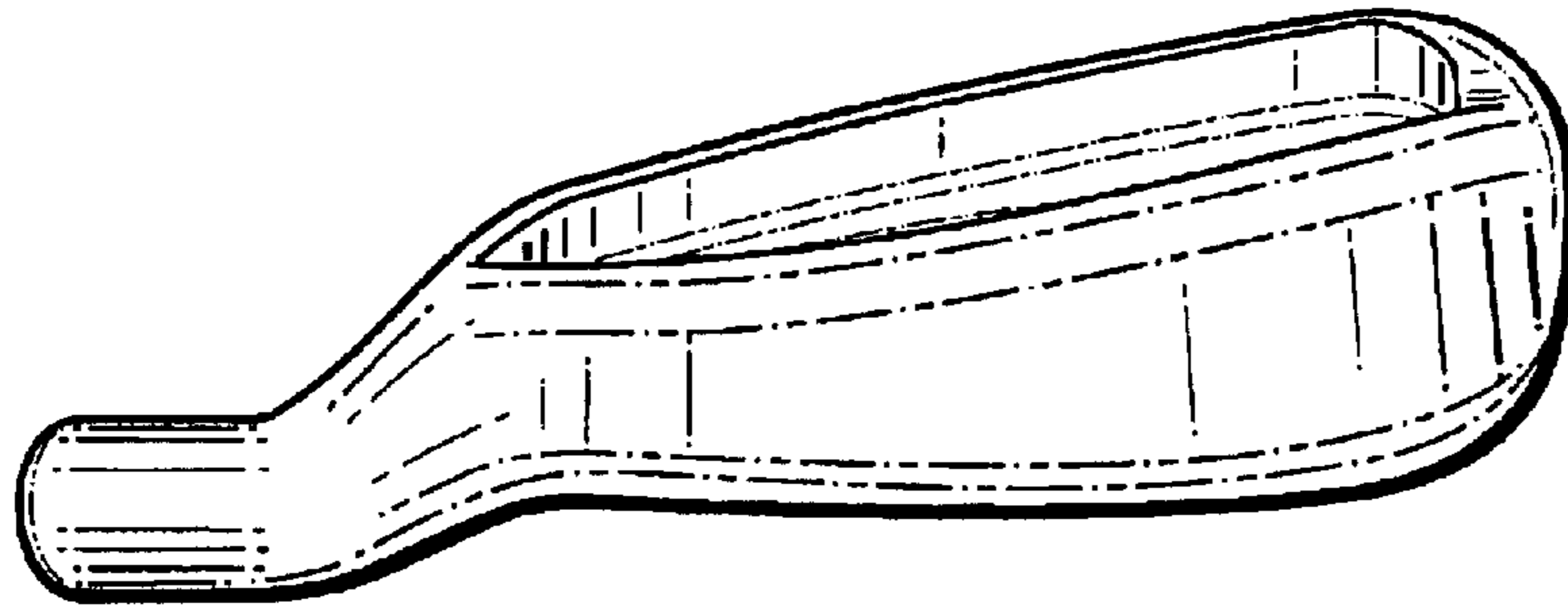
*Fig. 9*



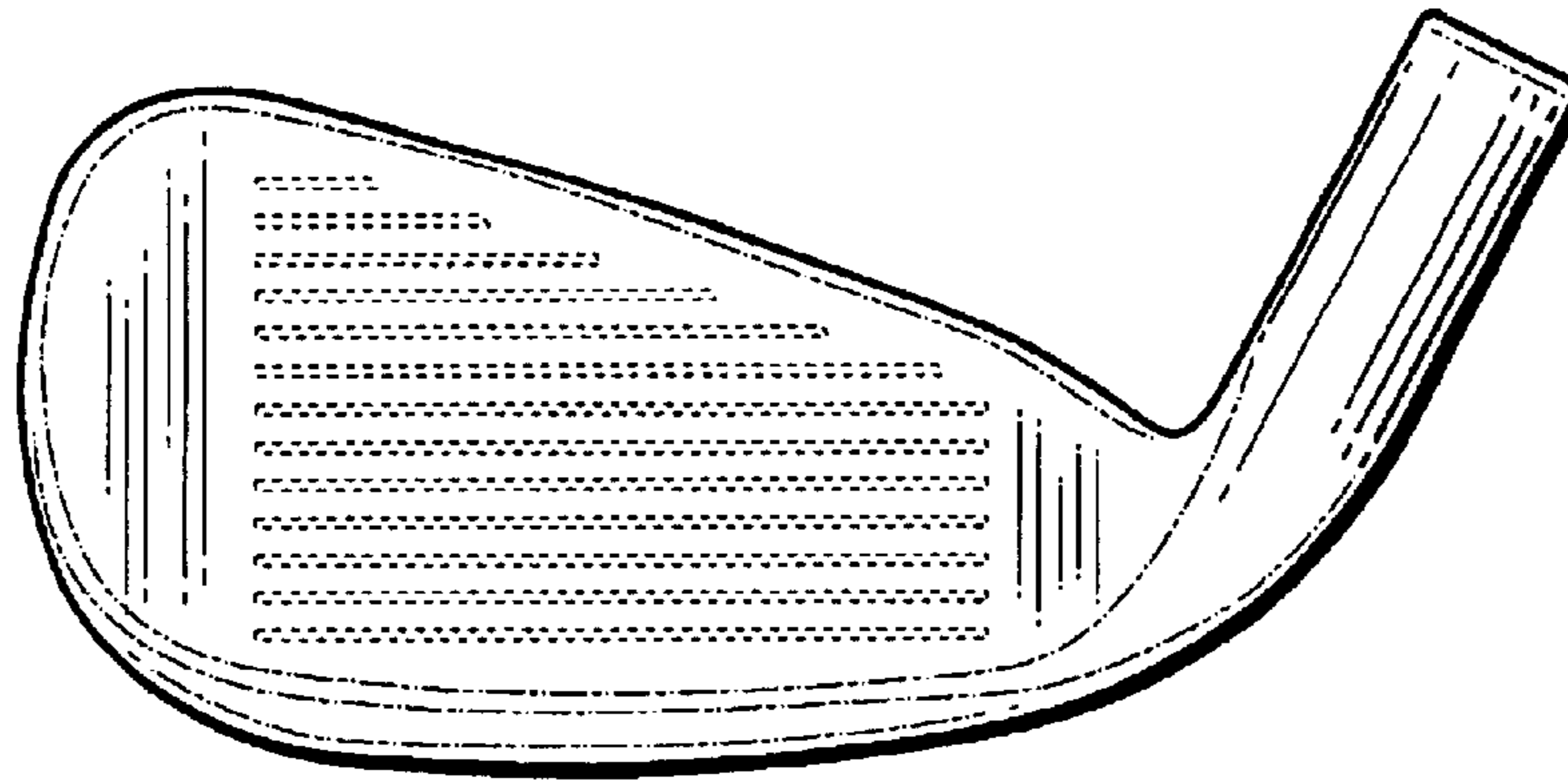
*Fig. 10*



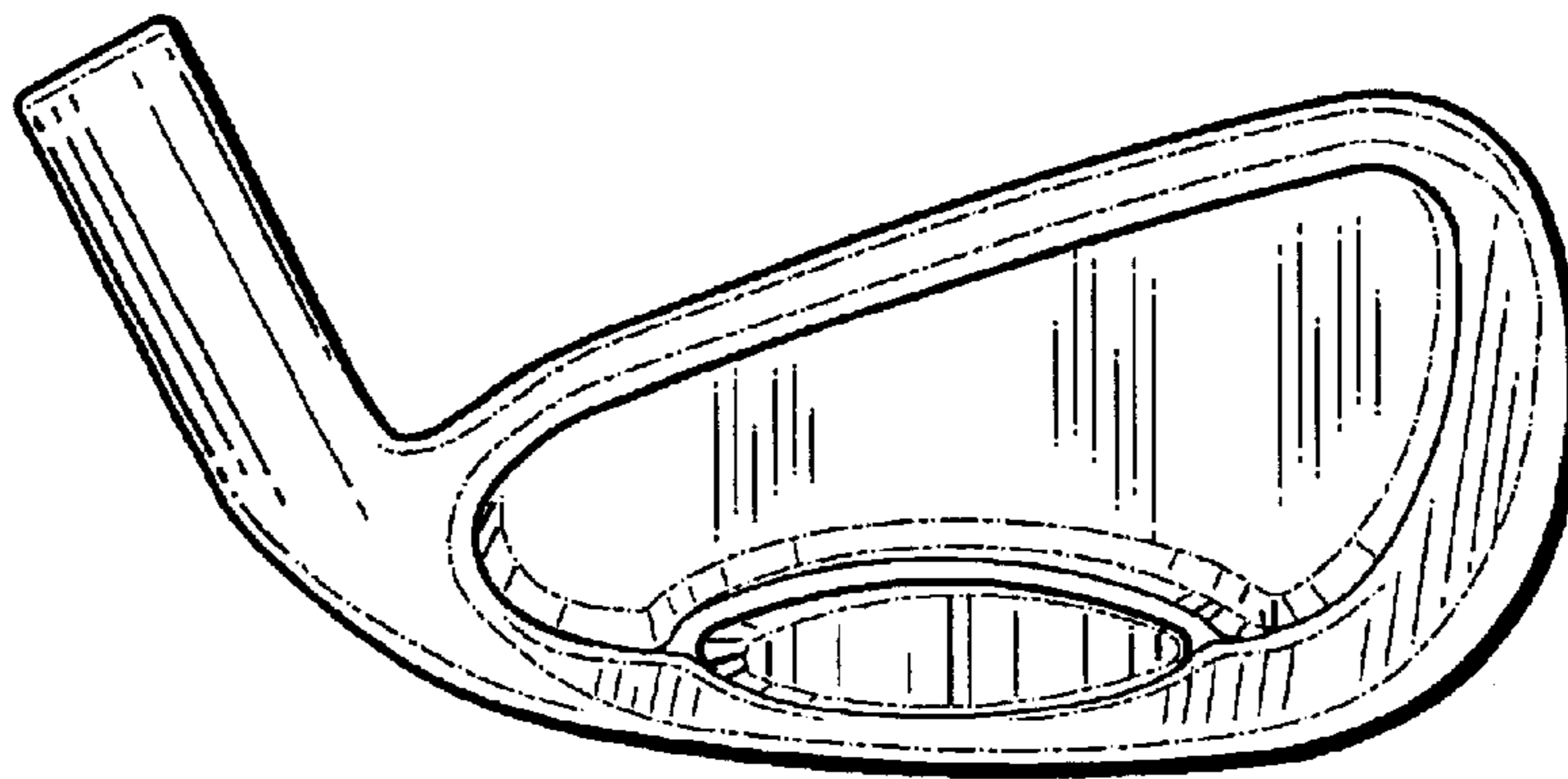
*Fig. 11*



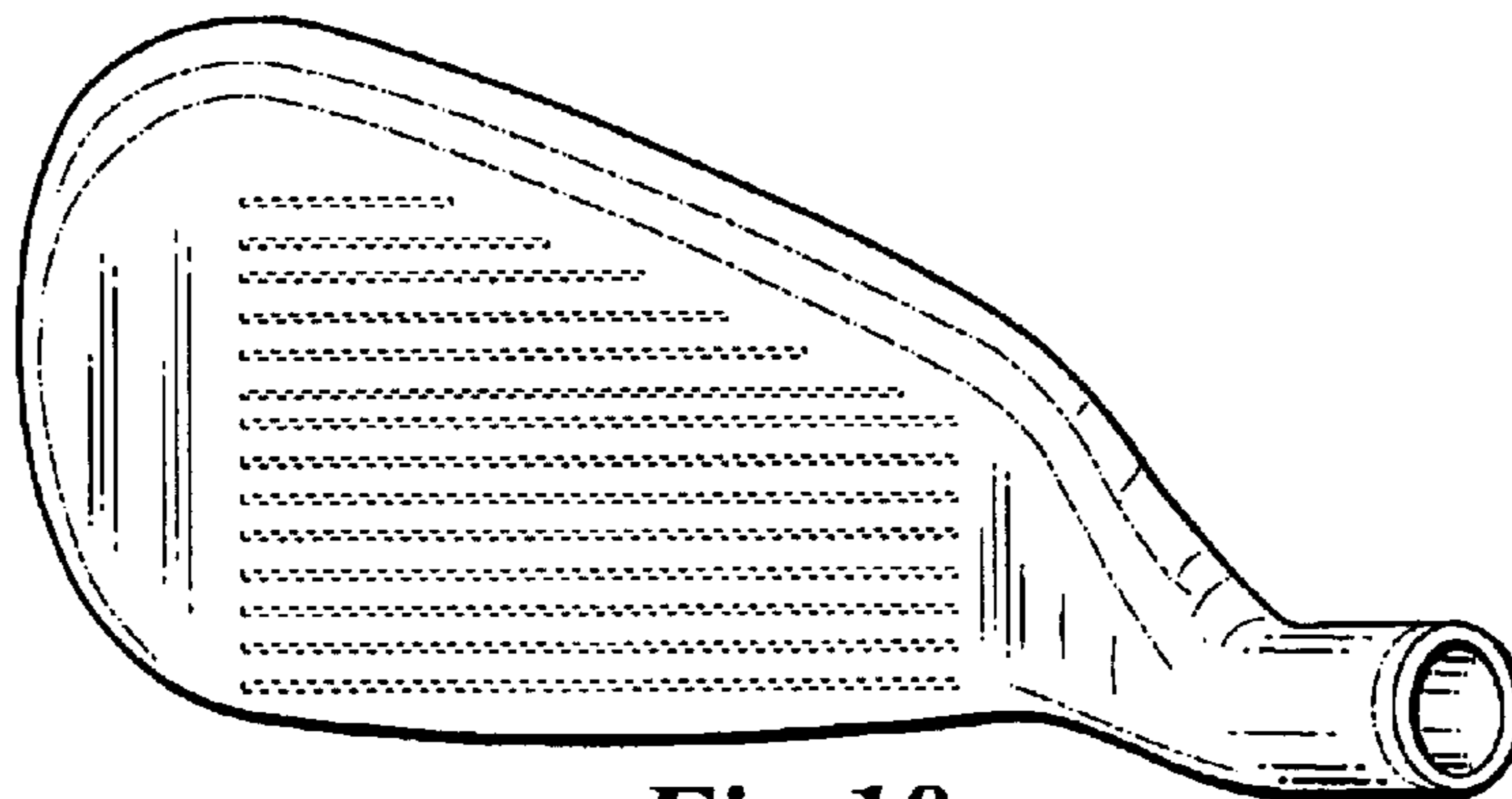
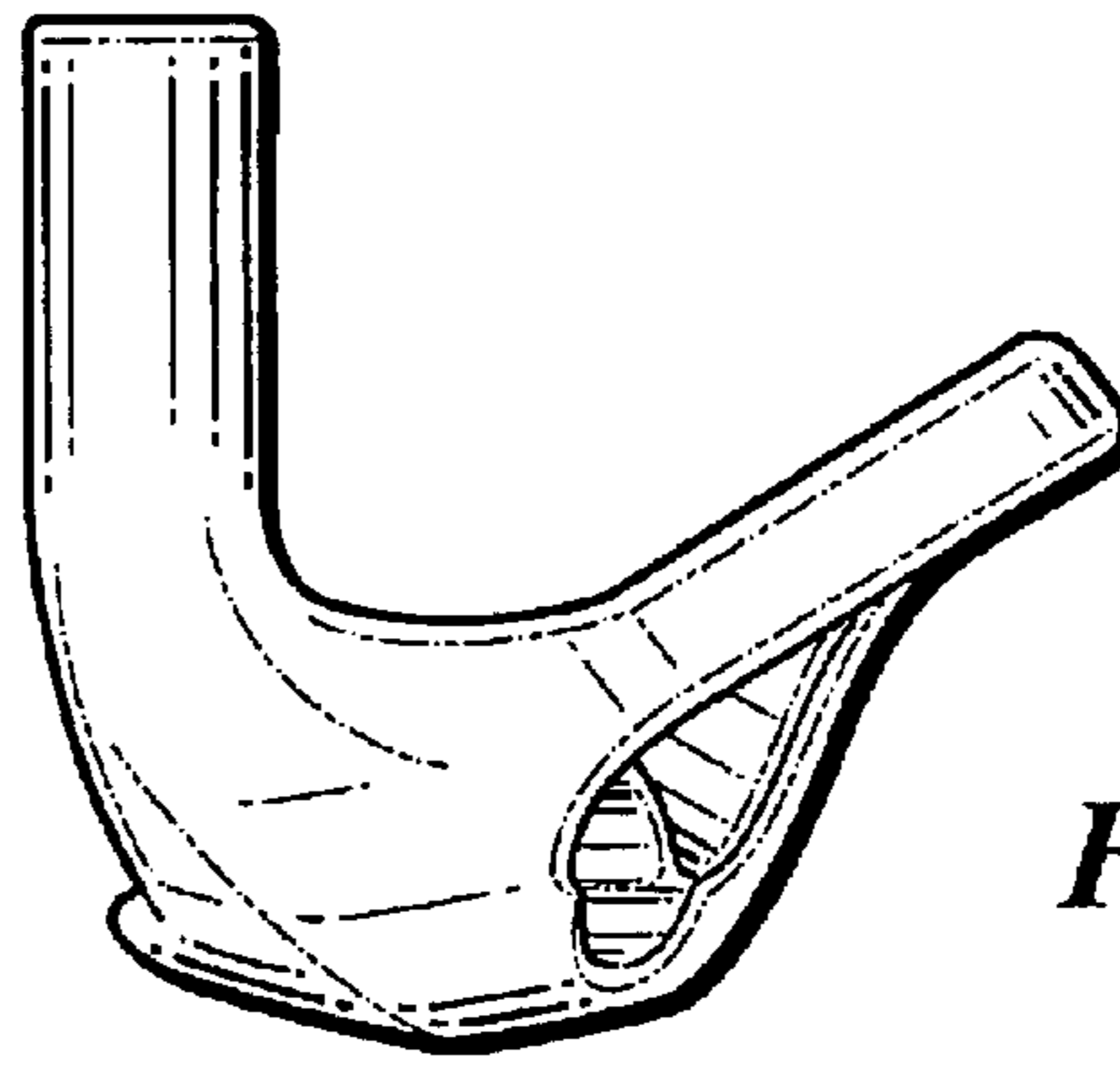
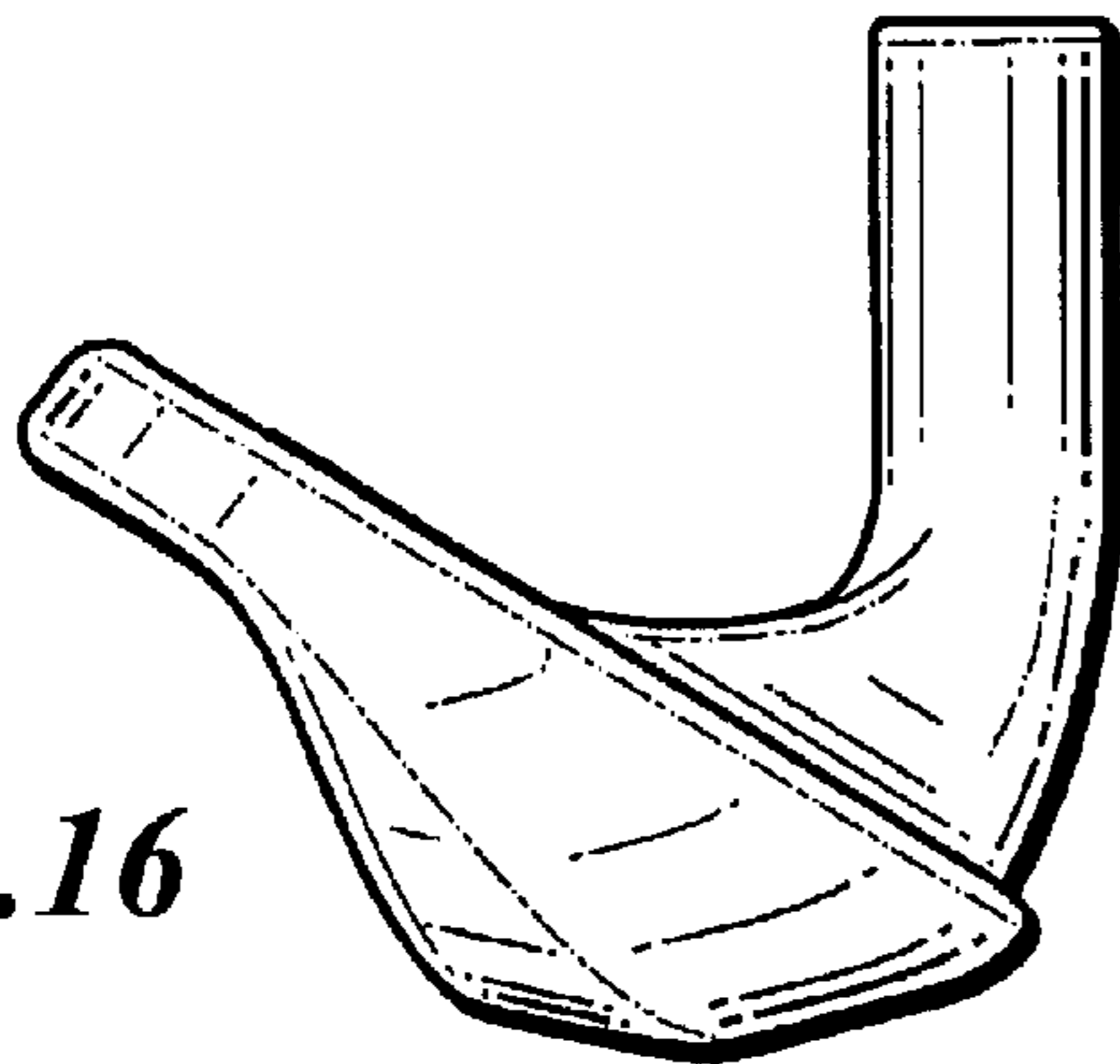
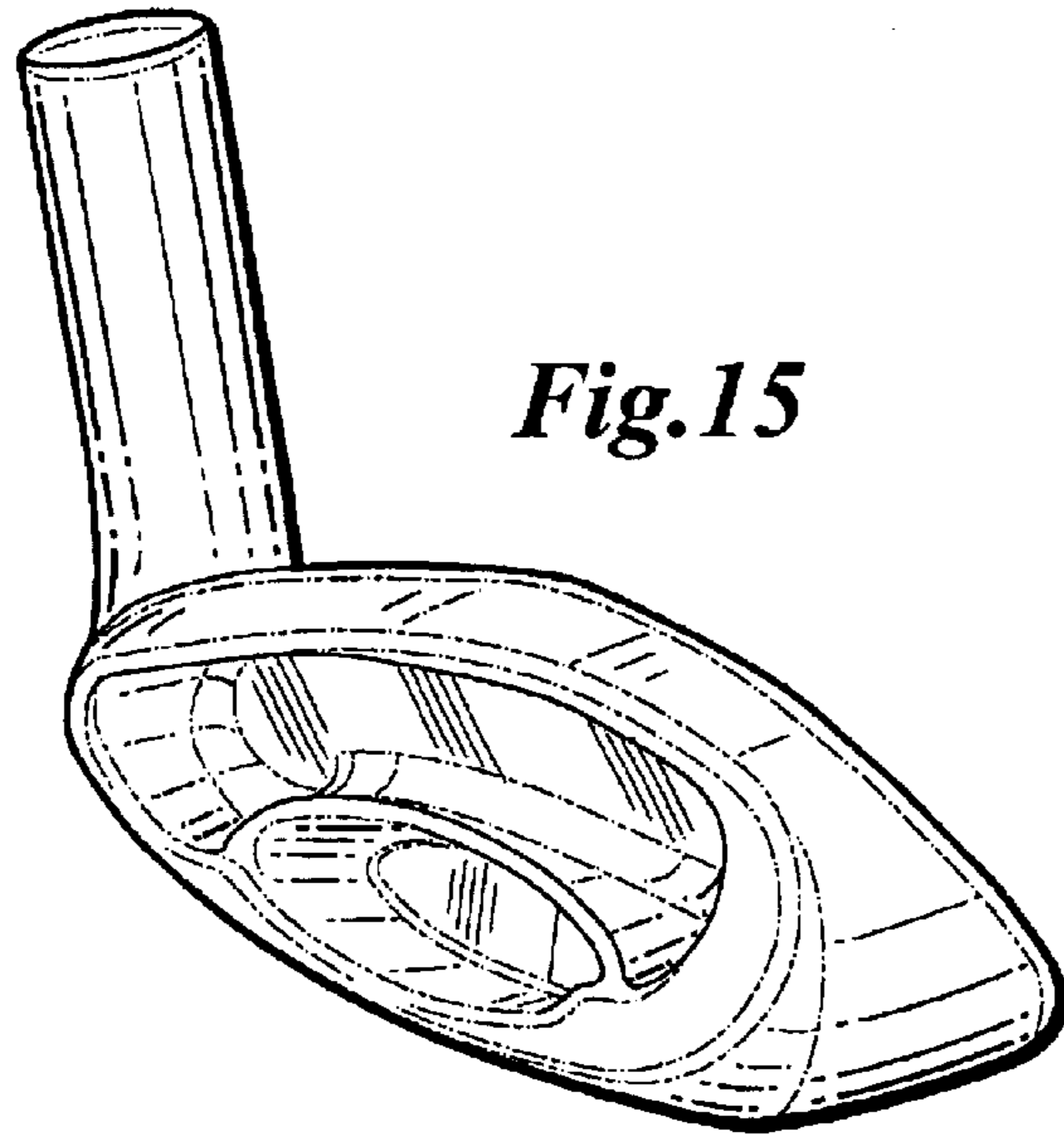
*Fig. 12*

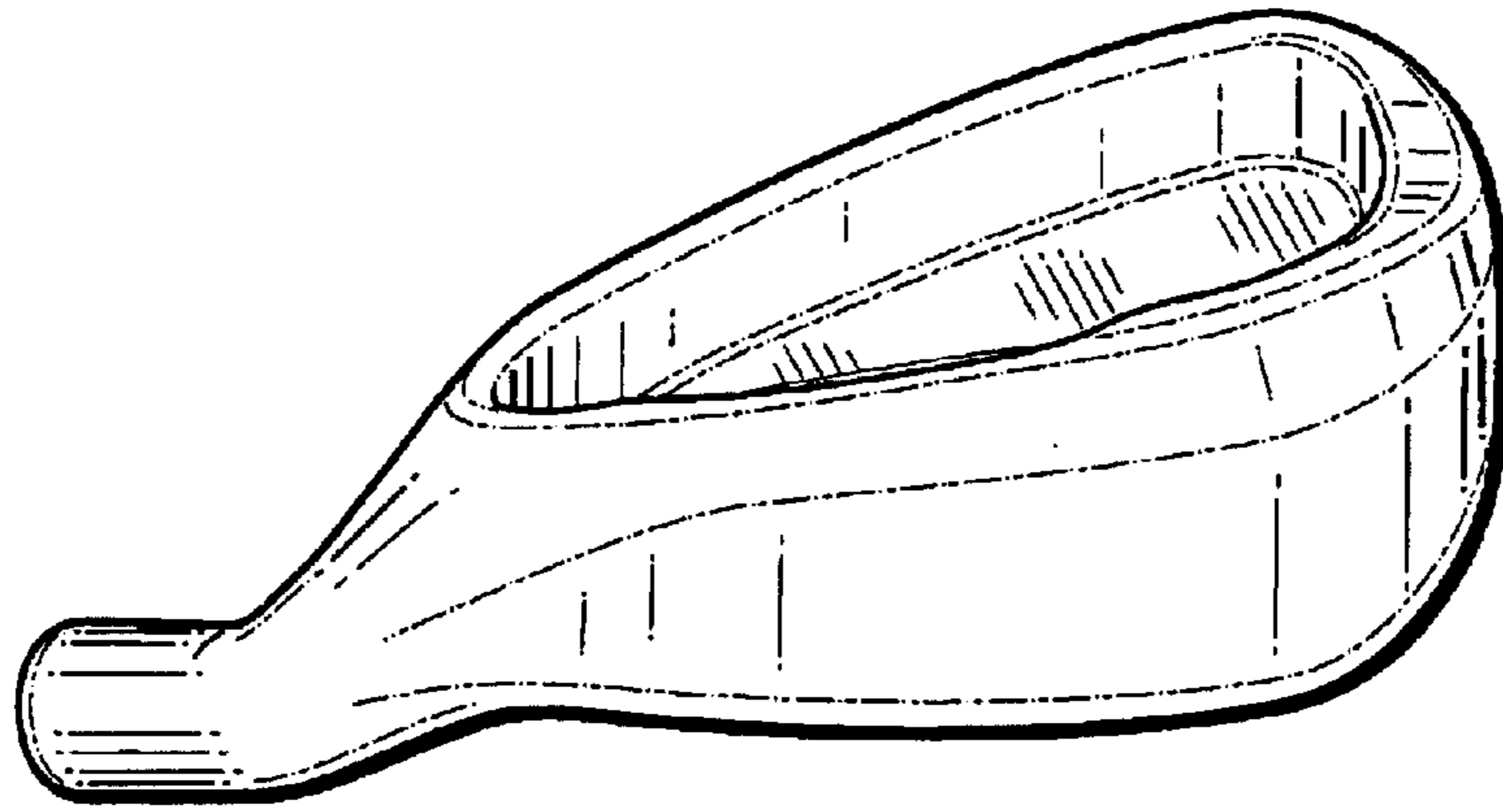


*Fig. 13*

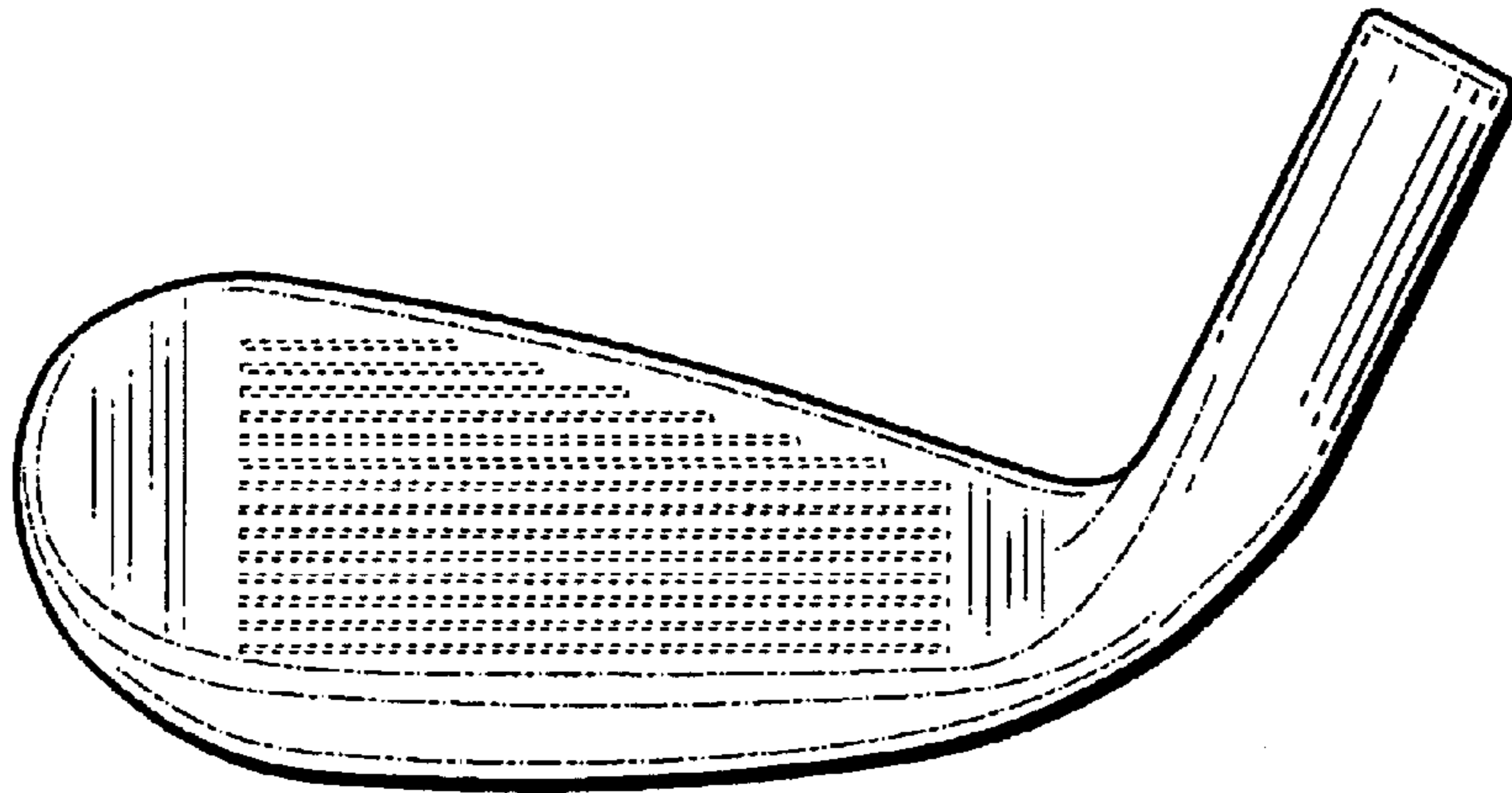


*Fig. 14*

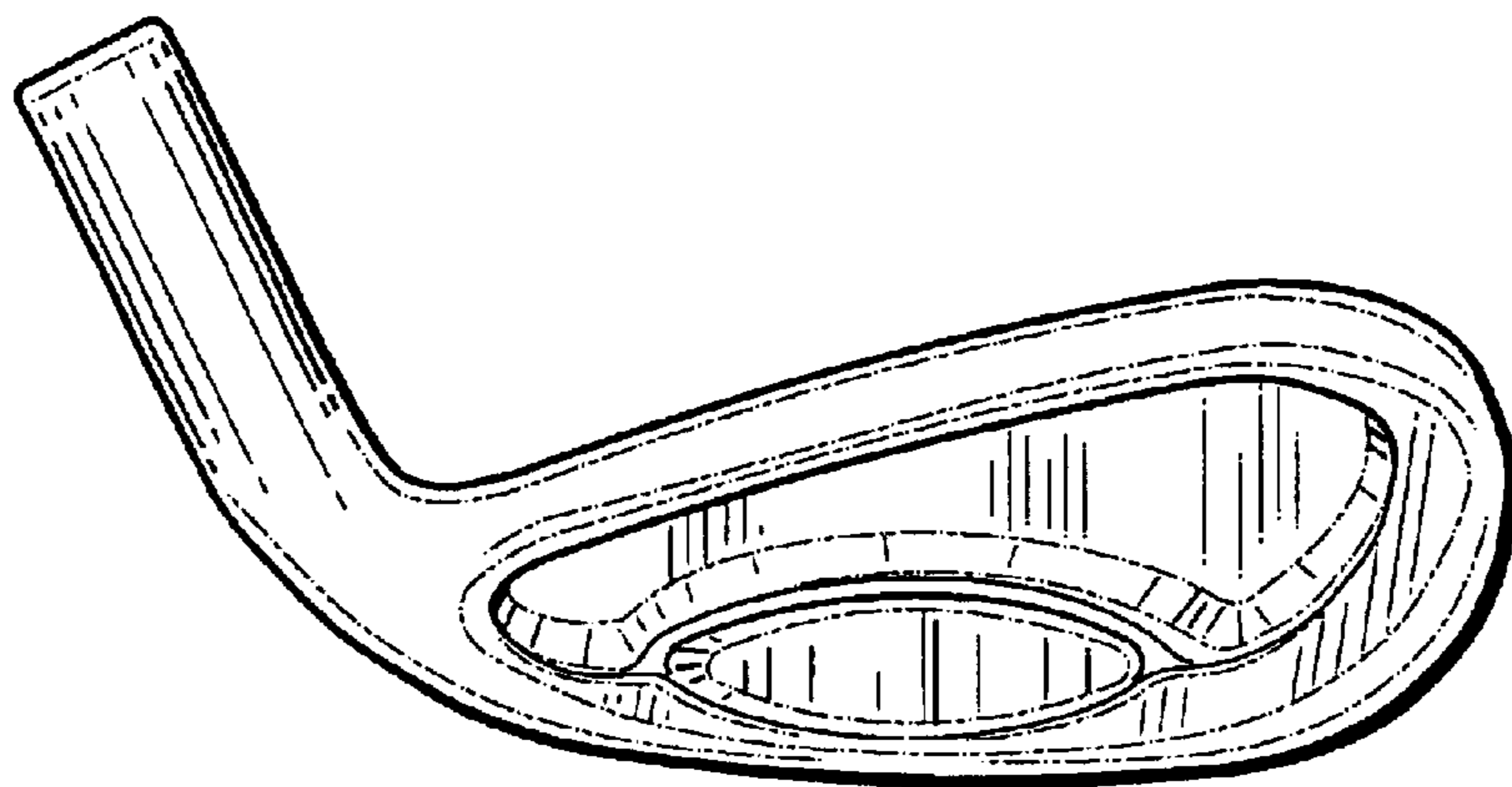




*Fig.19*



*Fig.20*



*Fig.21*