

US00D494597S1

(12) **United States Design Patent** (10) **Patent No.:** **US D494,597 S**
Lucas et al. (45) **Date of Patent:** **** Aug. 17, 2004**

(54) **SWIPE AND PARK CARD READER FOOTPRINT**

DESCRIPTION

(75) Inventors: **Bennie Lucas**, Long Beach, CA (US);
Kevin Tayeban, Los Angeles, CA (US);
Jerry Parson, Long Beach, CA (US);
Justin McJones, Rancho Palos Verdes,
CA (US)

(73) Assignee: **Mag-Tek, Inc.**, Carson, CA (US)

(**) Term: **14 Years**

(21) Appl. No.: **29/176,729**

(22) Filed: **Feb. 26, 2003**

(51) **LOC (7) Cl.** **14-02**

(52) **U.S. Cl.** **D14/453; D14/385**

(58) **Field of Search** **D14/383-386,**
D14/453; D18/36, 37, 39; 235/380, 382,
382.5, 451; 382/124-126

(56) **References Cited**

U.S. PATENT DOCUMENTS

D320,200 S * 9/1991 Kirwan et al. D14/453
D332,950 S * 2/1993 Kirwan et al. D14/453

* cited by examiner

Primary Examiner—Freda S. Nunn

(74) *Attorney, Agent, or Firm*—Christie, Parker & Hale,
LLP

(57) **CLAIM**

The ornamental design for swipe and park card reader footprint, as shown and described.

FIG. 1 is a front elevational view of a swipe and park card reader footprint according to a first embodiment of our new design;

FIG. 2 is a front view thereof;

FIG. 3 is a top view thereof;

FIG. 4 is a rear view thereof;

FIG. 5 is a bottom view thereof;

FIG. 6 is a first side view thereof;

FIG. 7 is a second side view thereof;

FIG. 8 is a front elevational view of a swipe and park card reader footprint according to a second embodiment of our new design;

FIG. 9 is a front view thereof;

FIG. 10 is a top view thereof;

FIG. 11 is a rear view thereof;

FIG. 12 is a bottom view thereof;

FIG. 13 is a first side view thereof;

FIG. 14 is a second side view thereof;

FIG. 15 is a front elevational view of a swipe and park card reader footprint according to a third embodiment of our new design;

FIG. 16 is a front view thereof;

FIG. 17 is a top view thereof;

FIG. 18 is a rear view thereof;

FIG. 19 is a bottom view thereof;

FIG. 20 is a first side view thereof; and,

FIG. 21 is a second side view thereof.

1 Claim, 18 Drawing Sheets

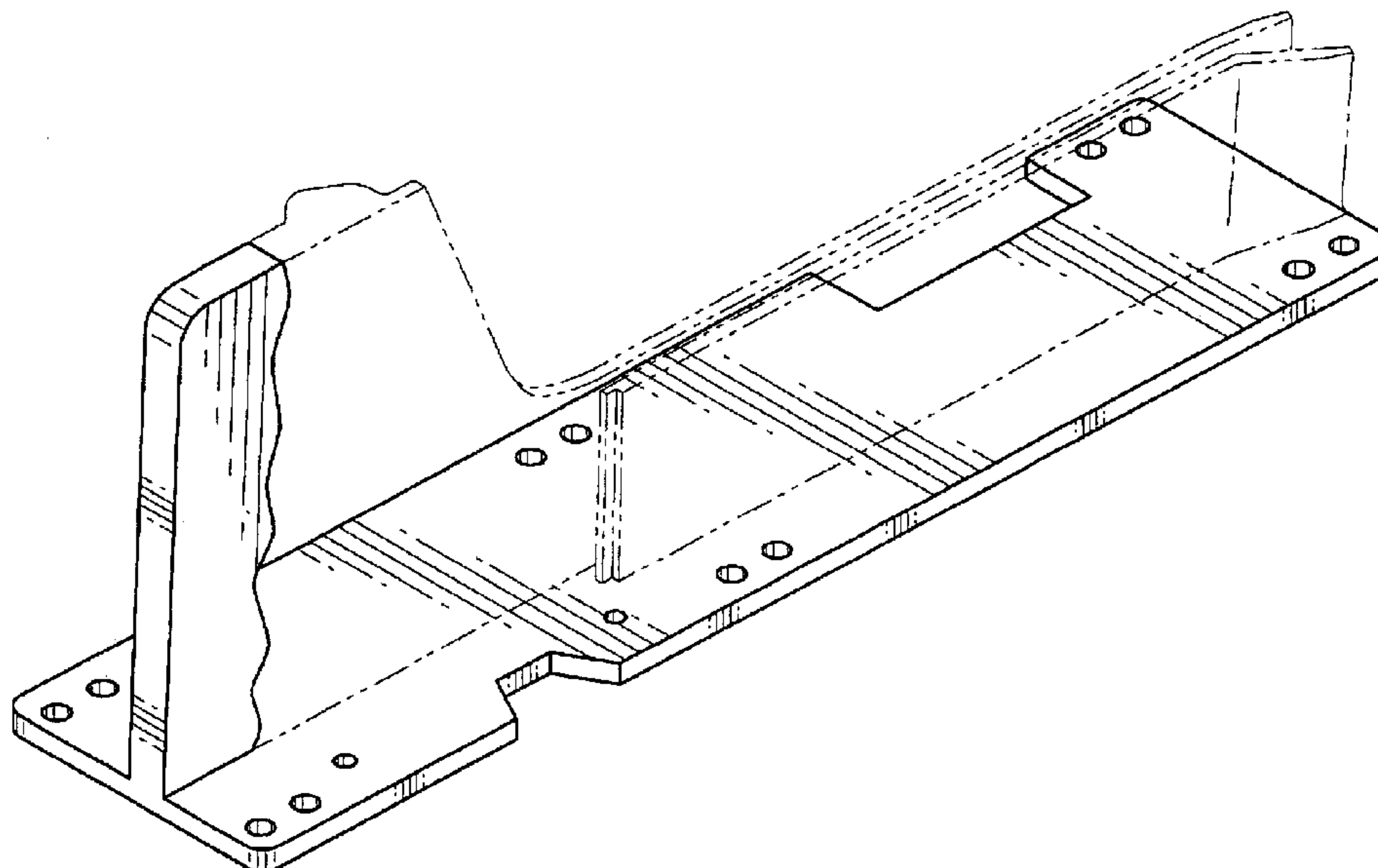

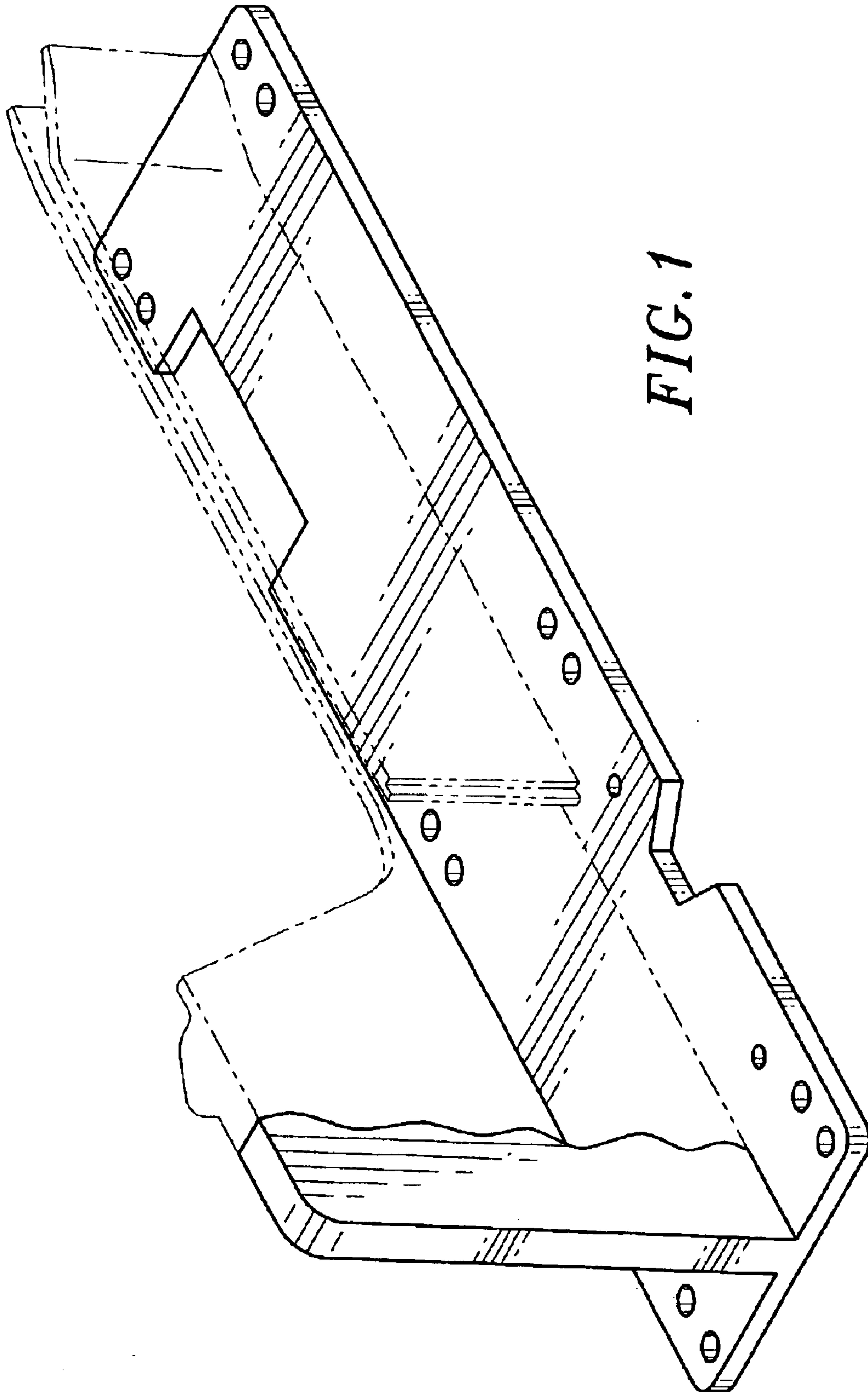

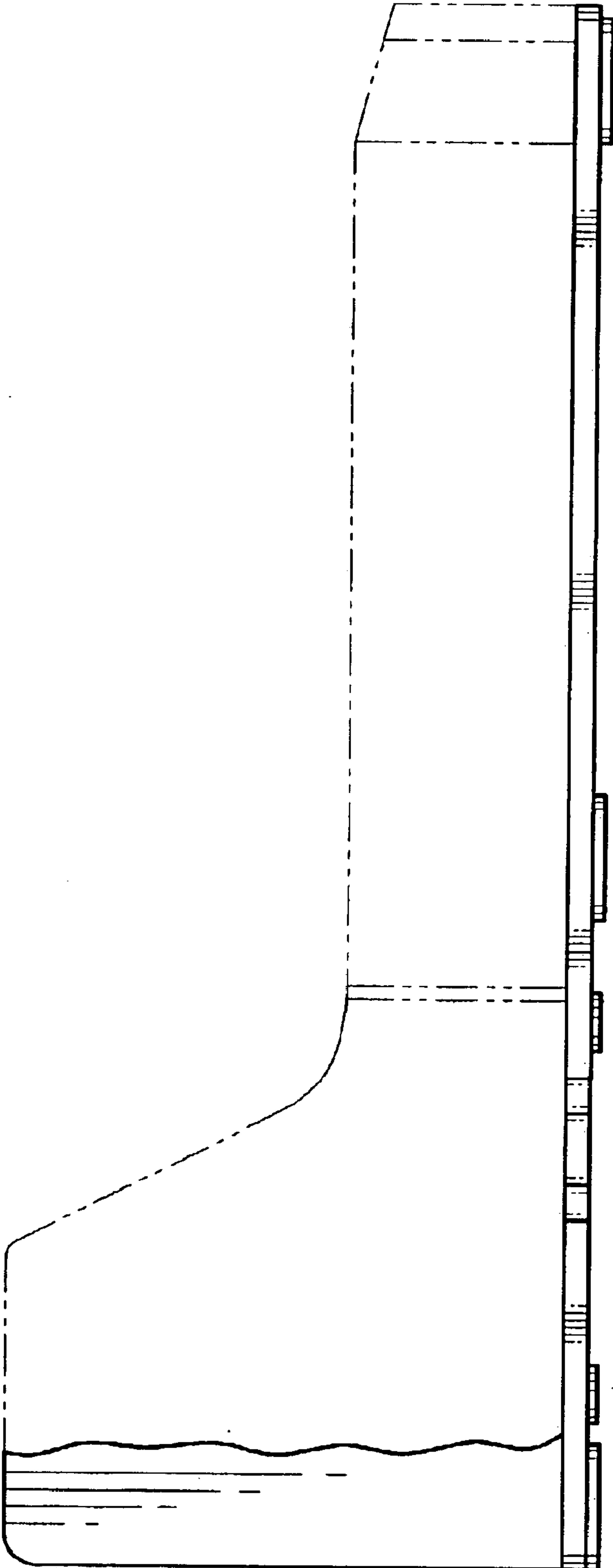

FIG. 2

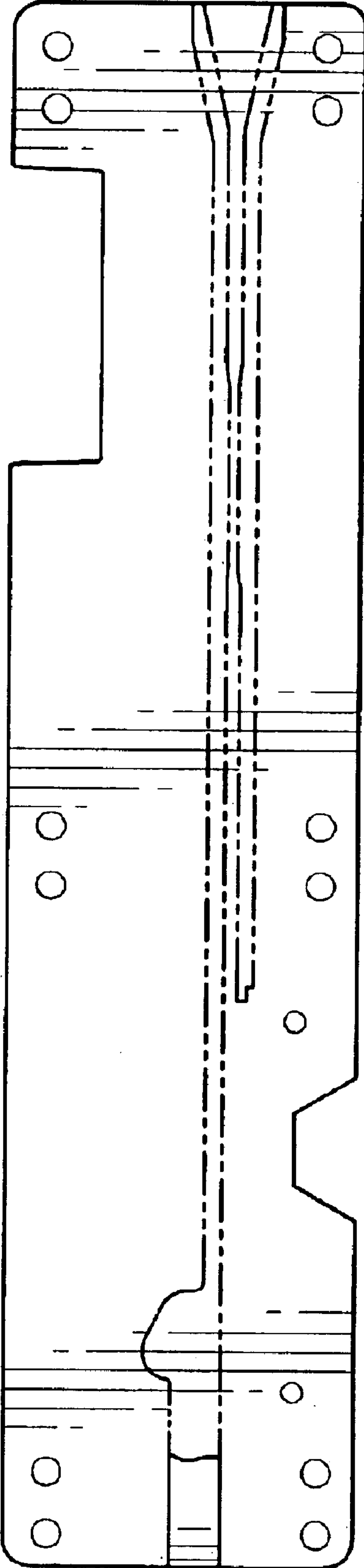

FIG. 3

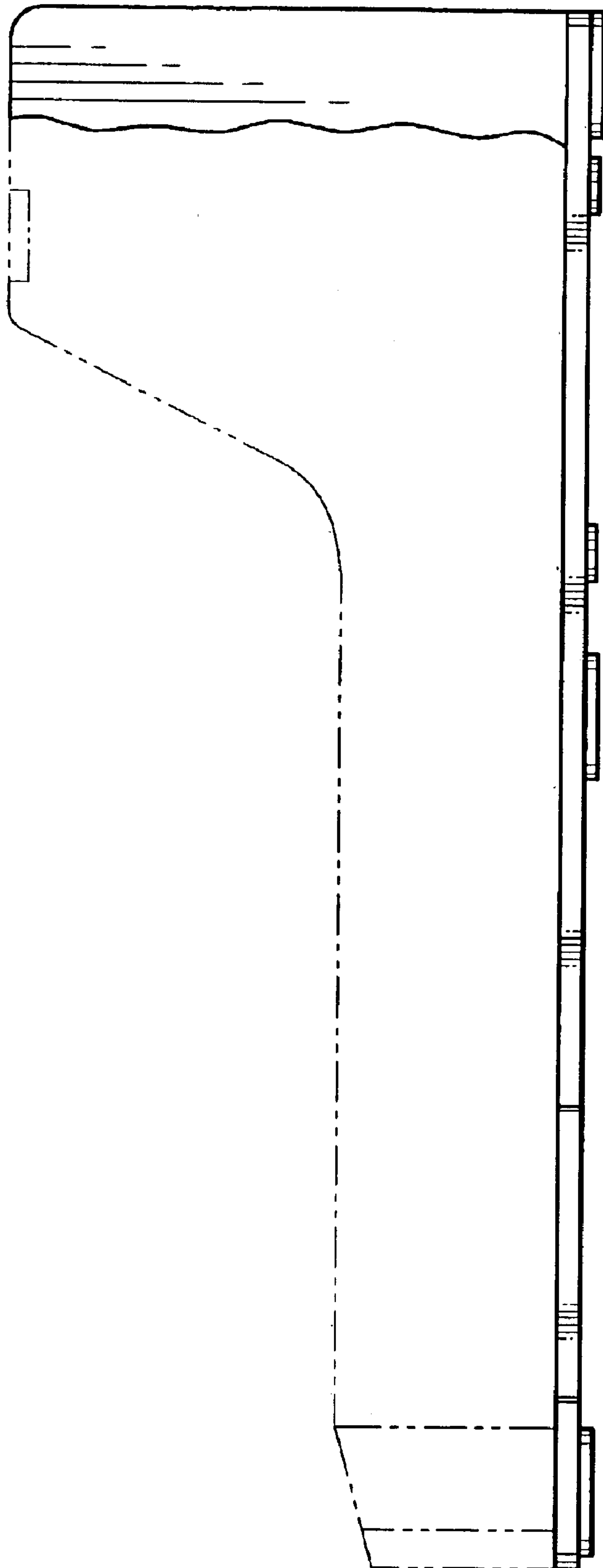

FIG. 4

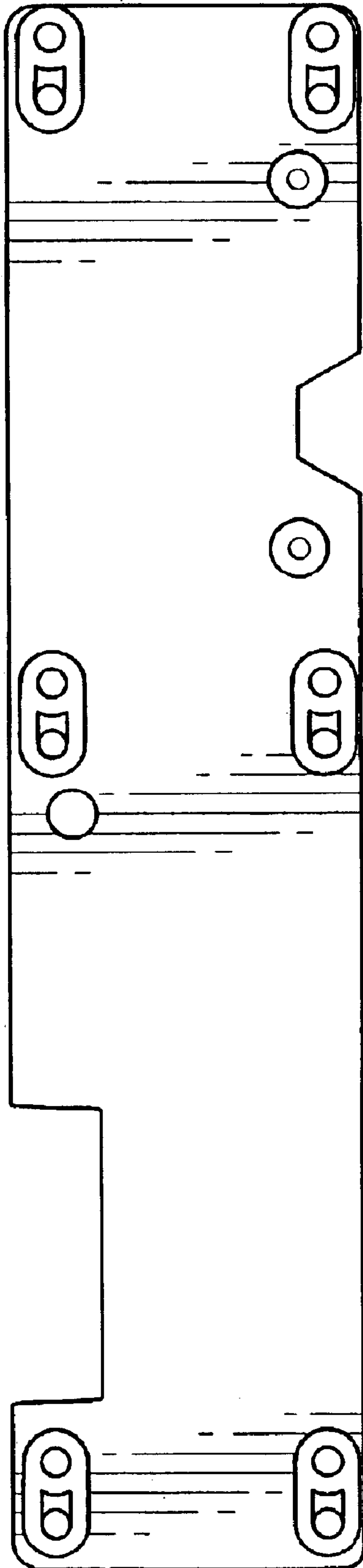

FIG. 5

FIG. 6

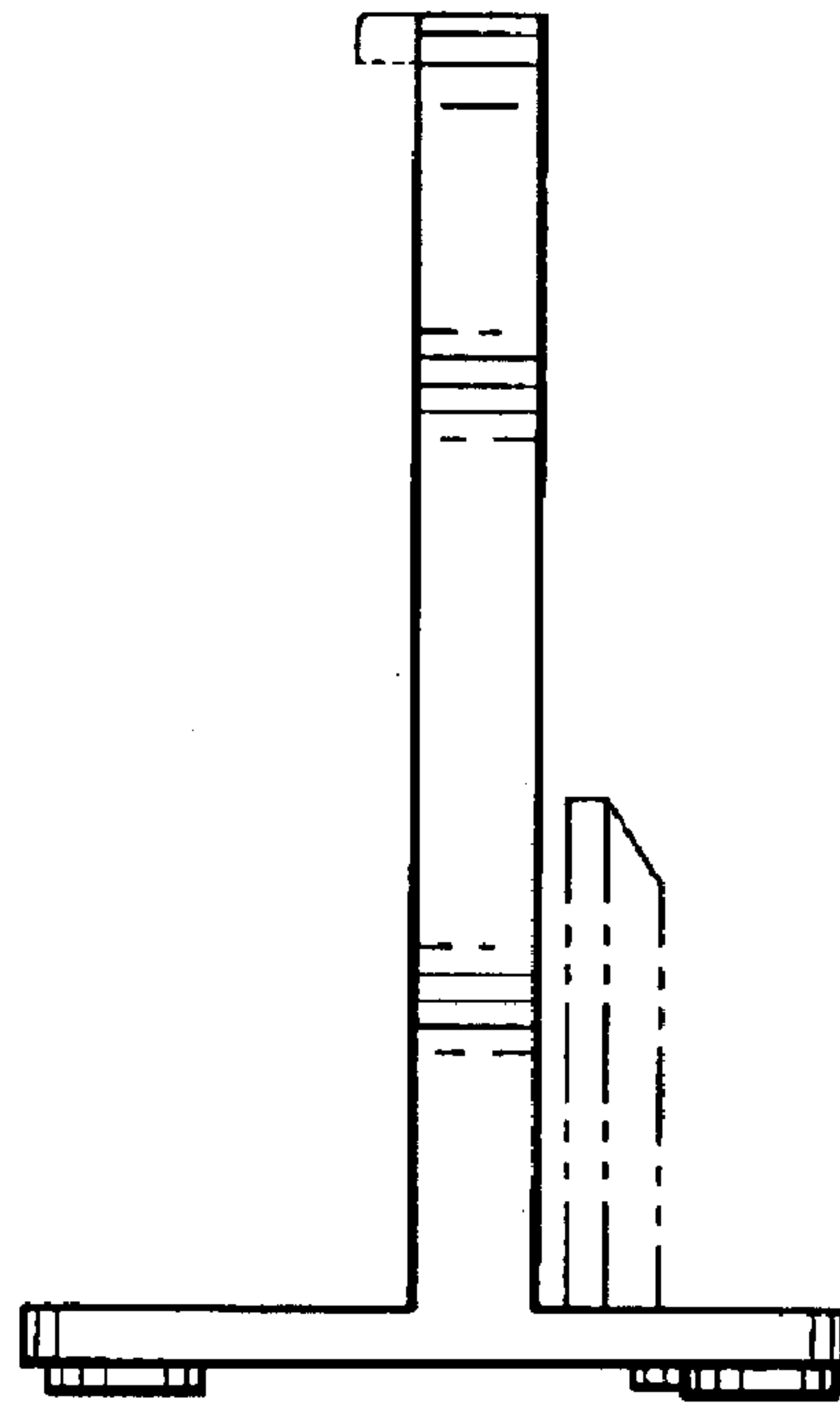
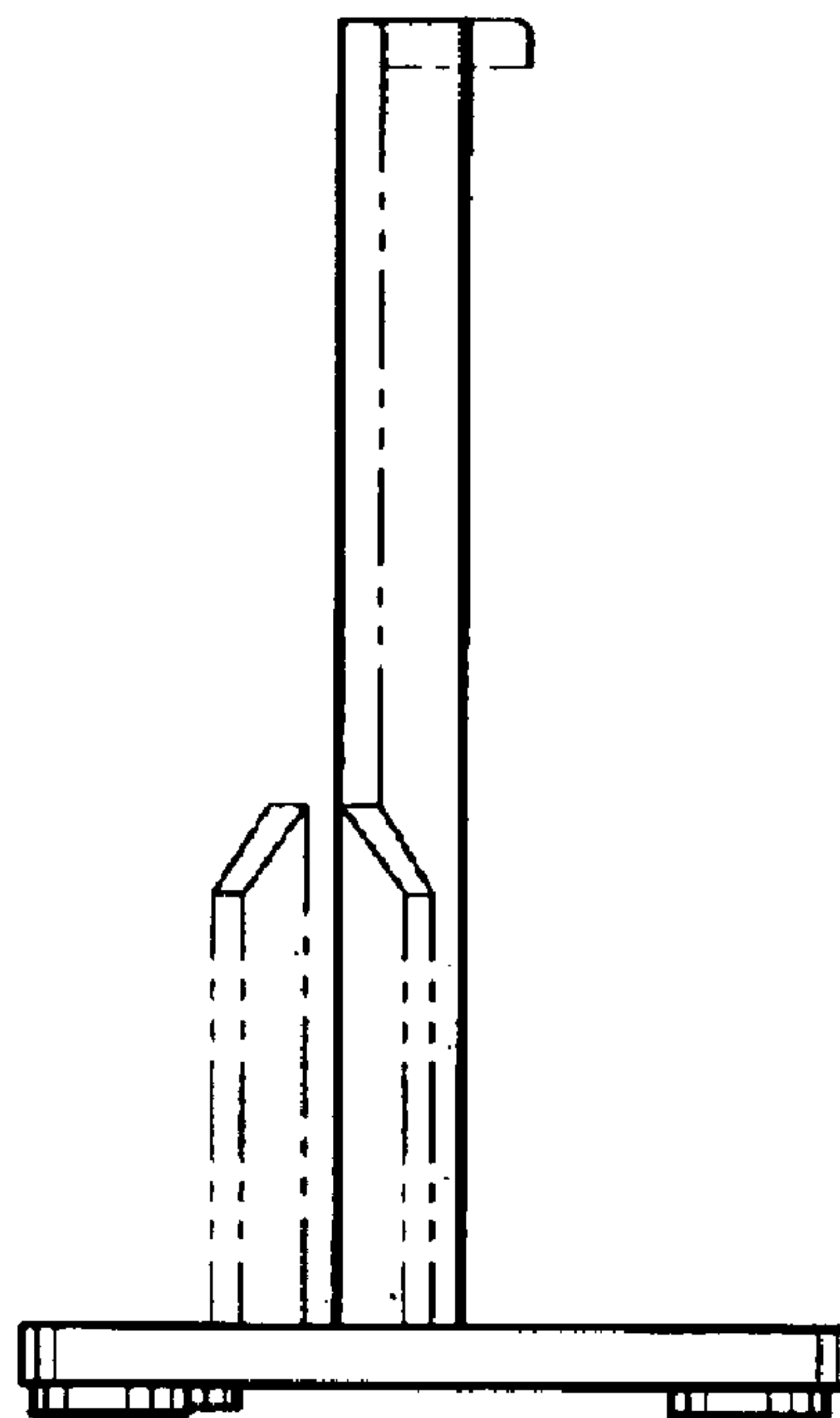

FIG. 7



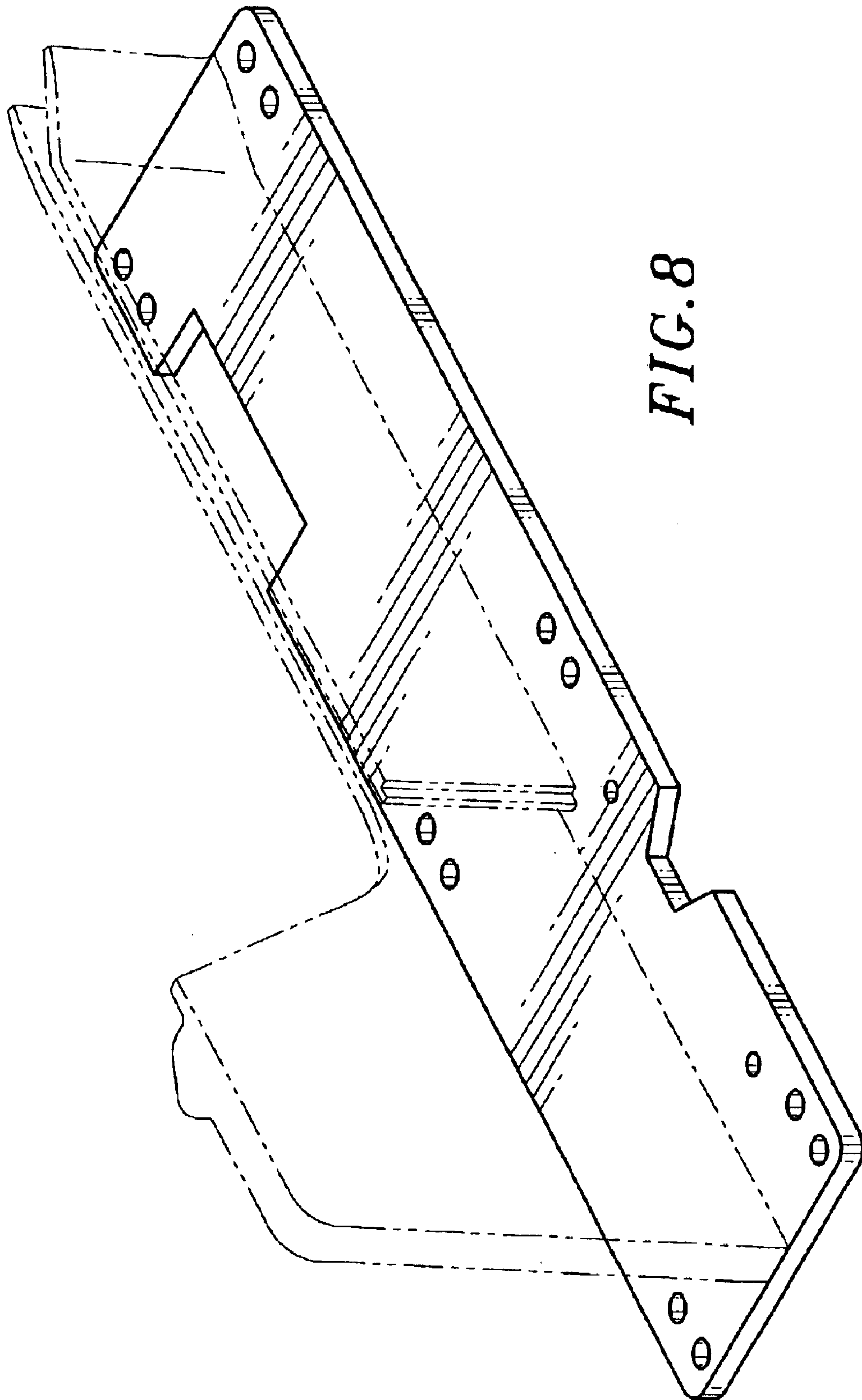

FIG. 8

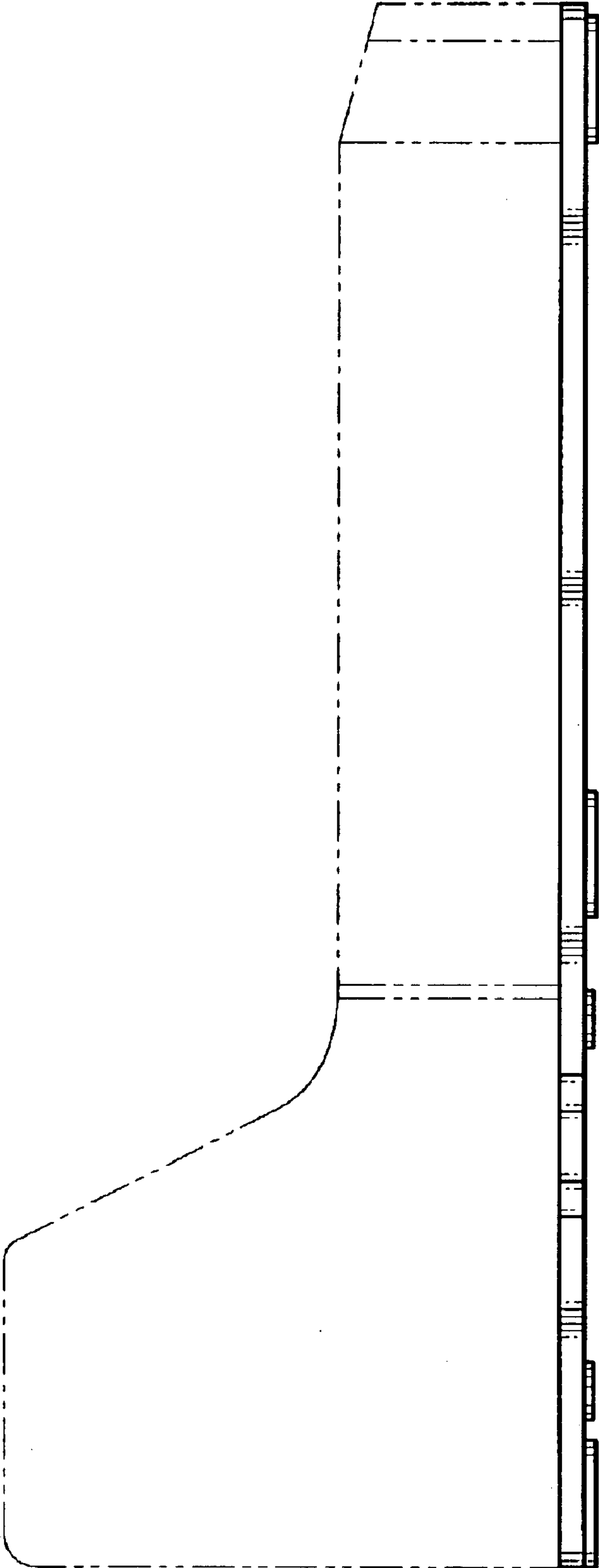

FIG. 9

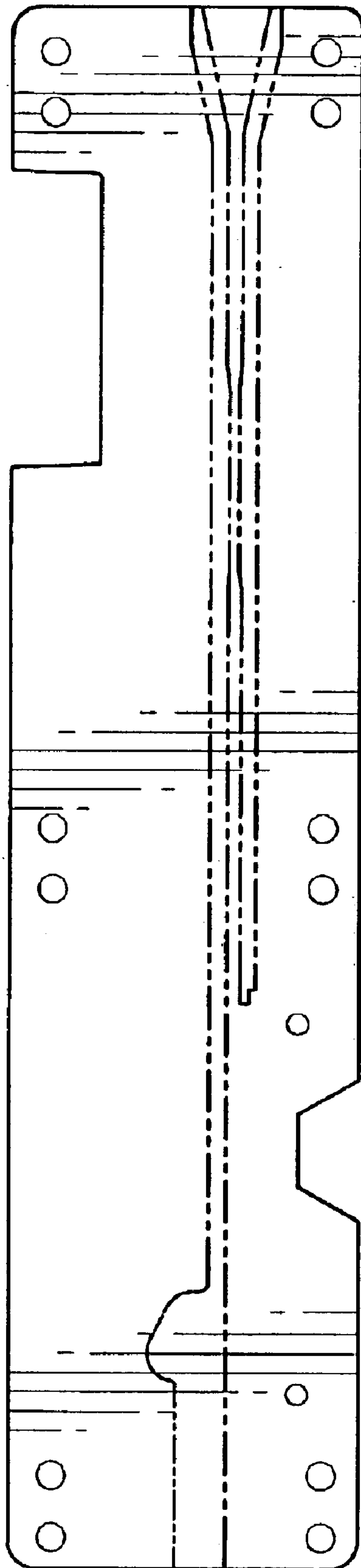

FIG. 10

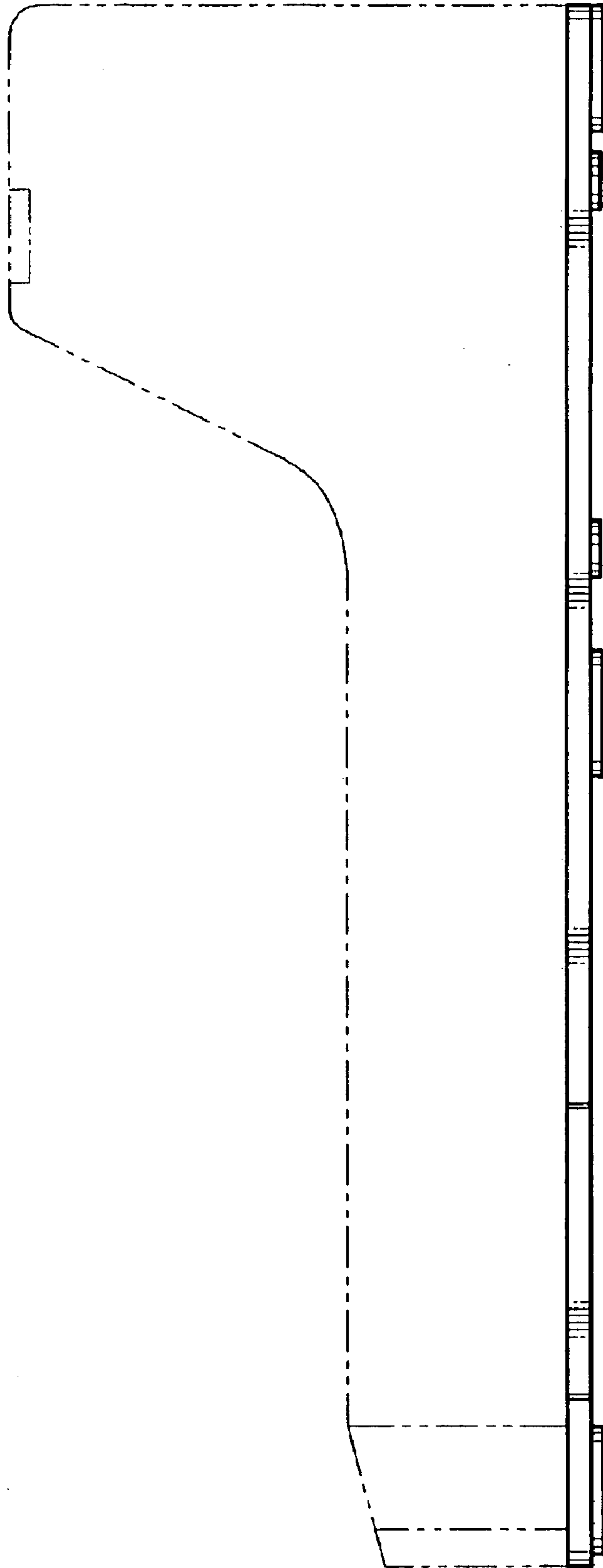

FIG. 11

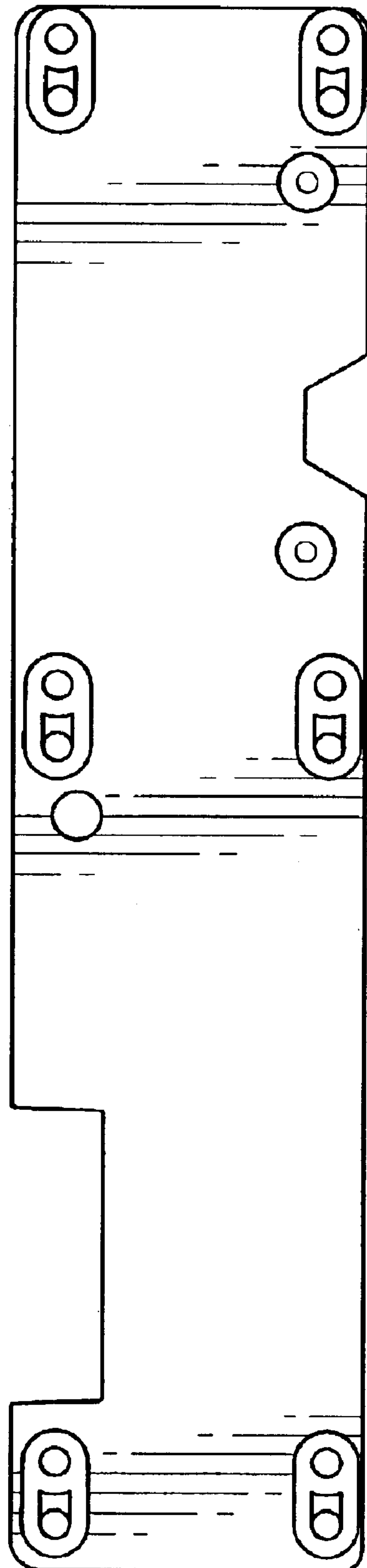

FIG. 12

FIG. 13

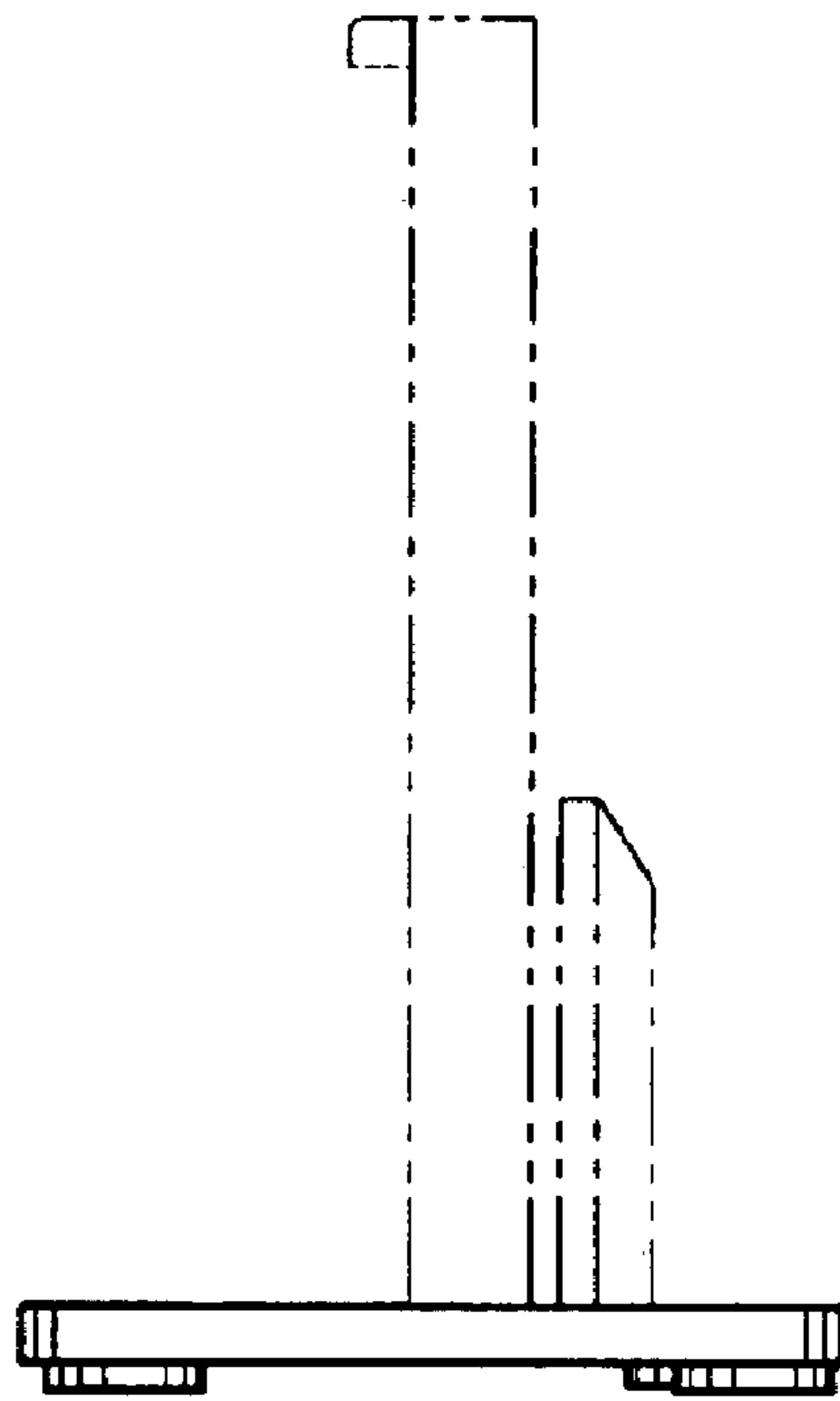
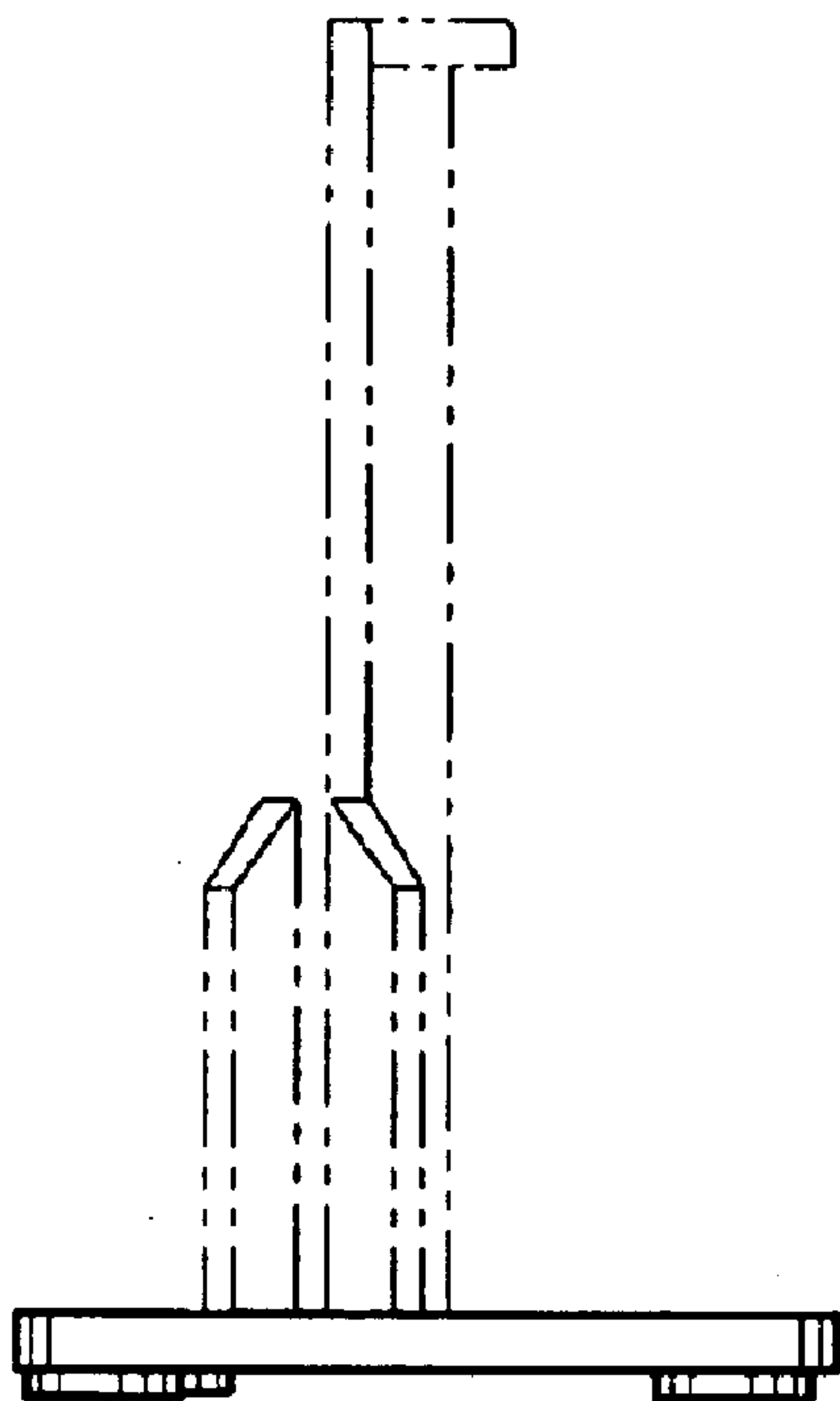

FIG. 14



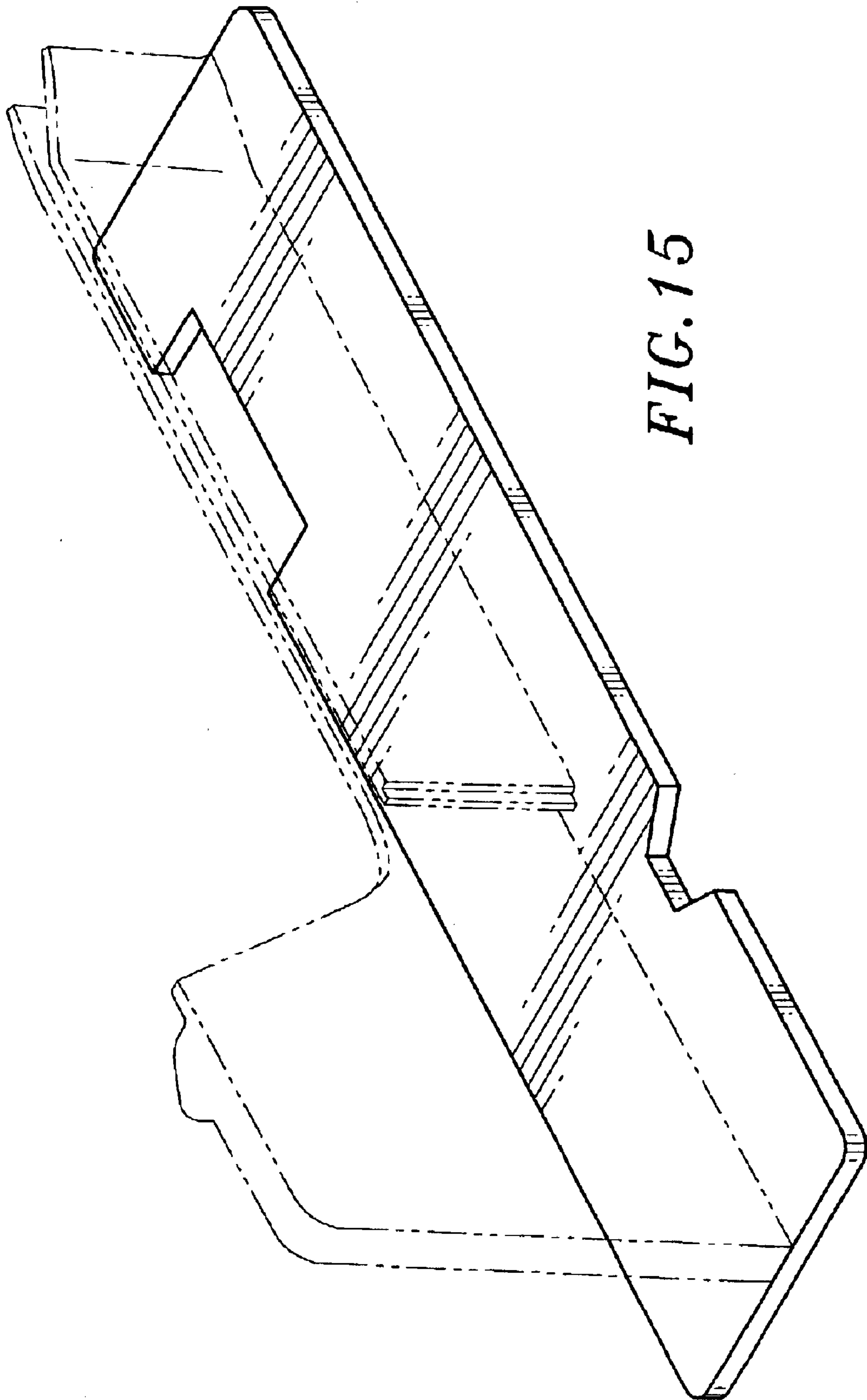

FIG. 15

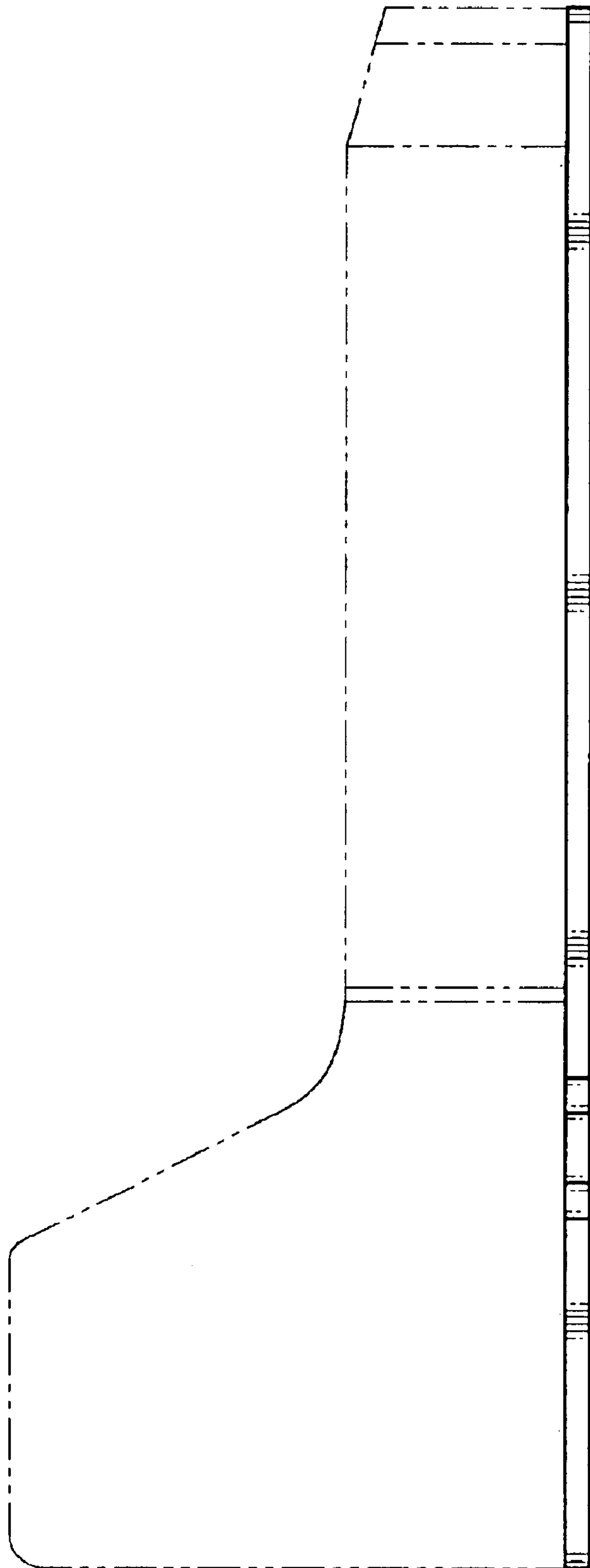

FIG. 16

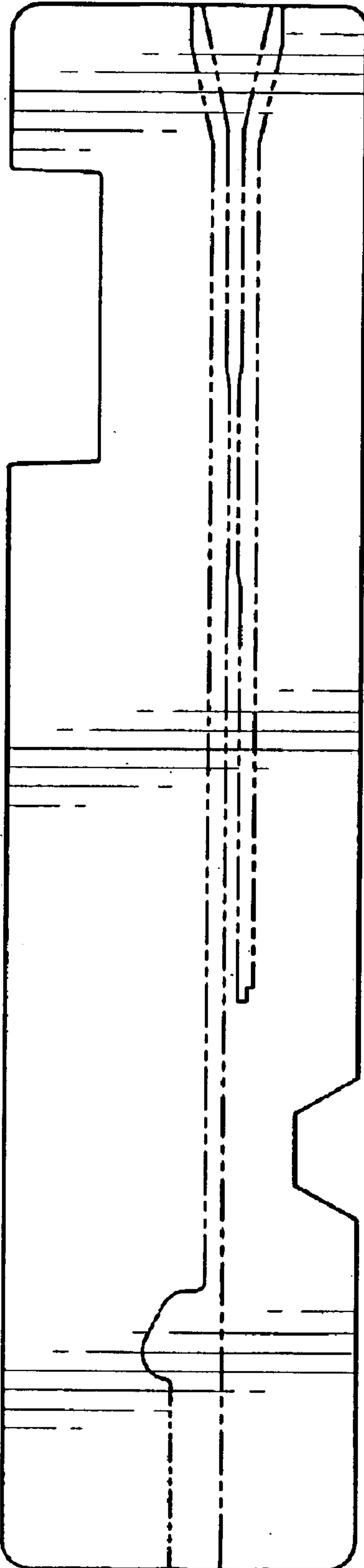

FIG. 17

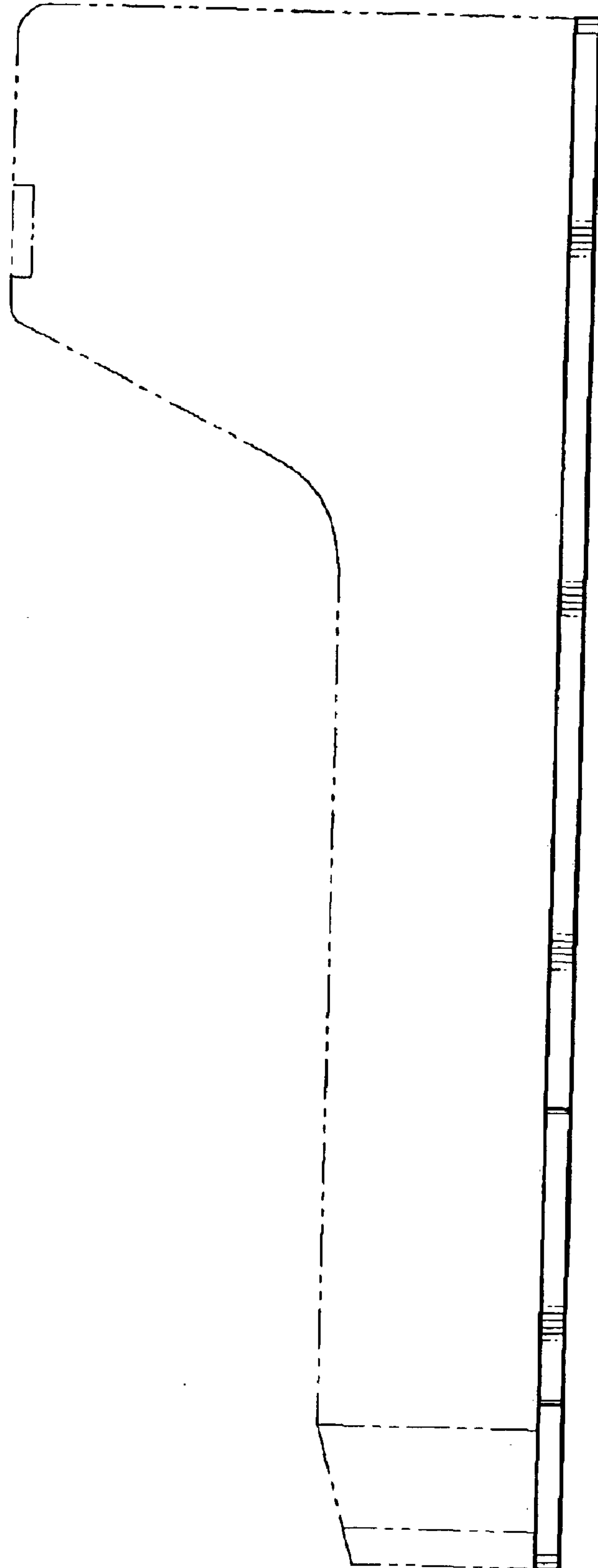

FIG. 18

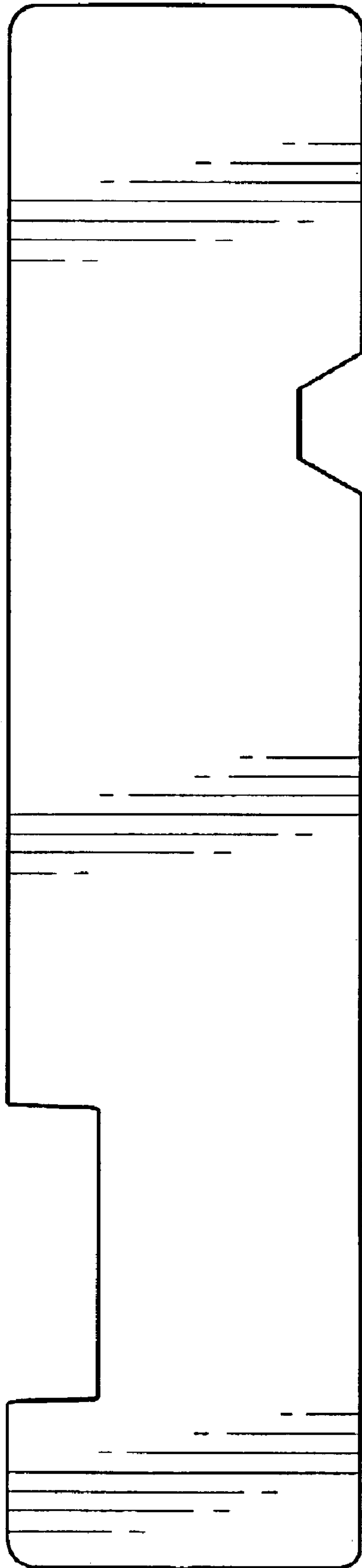

FIG. 19

FIG. 20

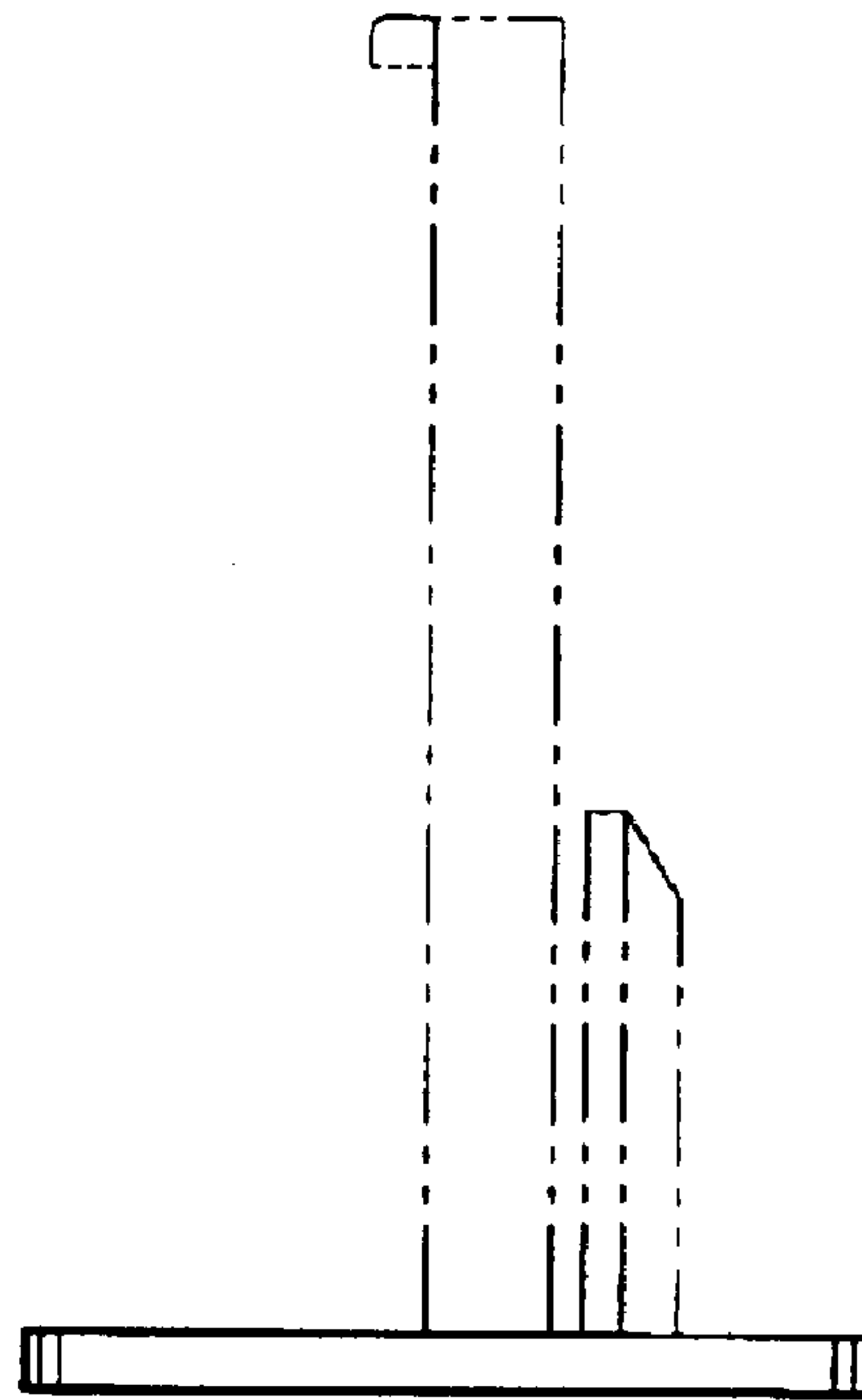

FIG. 21

