



US00D494561S1

(12) **United States Design Patent**  
**Kagami et al.**

(10) **Patent No.: US D494,561 S**

(45) **Date of Patent: \*\* Aug. 17, 2004**

- (54) **HANDSET**
- (75) Inventors: **Junichi Kagami**, Tokyo (JP); **Robert Shepherd**, Tarzana, CA (US)
- (73) Assignee: **Nokia Corporation**, Espoo (FI)
- (\*\*) Term: **14 Years**
- (21) Appl. No.: **29/183,523**
- (22) Filed: **Jun. 13, 2003**
- (51) **LOC (7) Cl. .... 14-03**
- (52) **U.S. Cl. .... D14/138**
- (58) **Field of Search** ..... D14/137, 138,  
D14/218, 147-148, 247-248, 144, 341-347;  
379/433.01-433.13, 419, 434, 428.01-428.04,  
420.01-420.04, 440; D10/65, 78; 455/550.1-90.3;  
D21/517; D13/168; D18/2, 7; 345/168,  
169

- D475,034 S \* 5/2003 Arbisi et al. .... D14/138
- D476,985 S \* 7/2003 Griffin ..... D14/247
- D478,324 S \* 8/2003 O'Neil ..... D14/138
- D478,882 S \* 8/2003 Peng et al. .... D14/138
- D479,216 S \* 9/2003 Ho-Cheun et al. .... D14/138
- D479,513 S \* 9/2003 Bricaud et al. .... D14/138
- D479,514 S \* 9/2003 Chan ..... D14/138
- D479,516 S \* 9/2003 Bricaud et al. .... D14/138
- D480,057 S \* 9/2003 HoCheun et al. .... D14/138
- D480,697 S \* 10/2003 Lee et al. .... D14/138
- D484,477 S \* 12/2003 Salmi ..... D14/138
- D484,885 S 1/2004 Arbisi
- D485,246 S \* 1/2004 Johansson et al. .... D14/138
- D486,458 S \* 2/2004 Chen et al. .... D14/138
- D487,066 S \* 2/2004 Gartrell et al. .... D14/138

**FOREIGN PATENT DOCUMENTS**

- WO DM/053863 \* 10/2000 ..... 14/3
- WO DM/055620 \* 4/2001 ..... 14/3
- WO DM/060 180 7/2002
- WO DM/062 301 1/2003
- WO DM/062 321 1/2003
- WO DM/064 013 8/2003
- WO DM/064 133 9/2003
- WO DM/064 218 10/2003

\* cited by examiner

*Primary Examiner*—Jeffrey Asch  
(74) *Attorney, Agent, or Firm*—Banner & Witcoff, Ltd.

(56) **References Cited**

**U.S. PATENT DOCUMENTS**

- D385,875 S \* 11/1997 Harris et al. .... D14/138
- D402,572 S \* 12/1998 Han ..... D10/65
- 6,014,552 A \* 1/2000 Aiken et al. .... 455/575.1
- D420,351 S \* 2/2000 Waldner ..... D14/138
- D433,017 S \* 10/2000 Martinez ..... D14/346
- D451,079 S \* 11/2001 Ali ..... D14/138
- D451,485 S 12/2001 Moss
- D454,849 S \* 3/2002 Eckholm ..... D14/138
- D456,794 S \* 5/2002 Laverick et al. .... D14/138
- D458,595 S \* 6/2002 Yin et al. .... D14/138
- D458,912 S \* 6/2002 DeLeon ..... D14/138
- D459,327 S \* 6/2002 Ali ..... D14/138
- D460,057 S \* 7/2002 Hunt ..... D14/138
- D485,482 S 11/2002 Nuovo
- D466,878 S \* 12/2002 Porter ..... D14/138
- D467,918 S \* 12/2002 Fitch et al. .... D14/347
- D469,367 S \* 1/2003 Mirabelli et al. .... D10/65
- D469,415 S \* 1/2003 Nam ..... D14/138
- D469,748 S \* 2/2003 Ribeiro et al. .... D14/138
- D469,750 S \* 2/2003 Nam ..... D14/138
- D470,467 S \* 2/2003 Maruska et al. .... D14/138
- D470,843 S \* 2/2003 Horiki ..... D14/346

(57) **CLAIM**

The ornamental design for a handset, as shown and described.

**DESCRIPTION**

FIG. 1 is a bottom view of a handset showing our new design;  
FIG. 2 is a right side view thereof;  
FIG. 3 is a front view thereof;  
FIG. 4 is a left side view thereof;  
FIG. 5 is a top plan view thereof;  
FIG. 6 is a rear view thereof;  
FIG. 7 is a perspective front view thereof; and,  
FIG. 8 is a perspective rear view thereof.

**1 Claim, 3 Drawing Sheets**

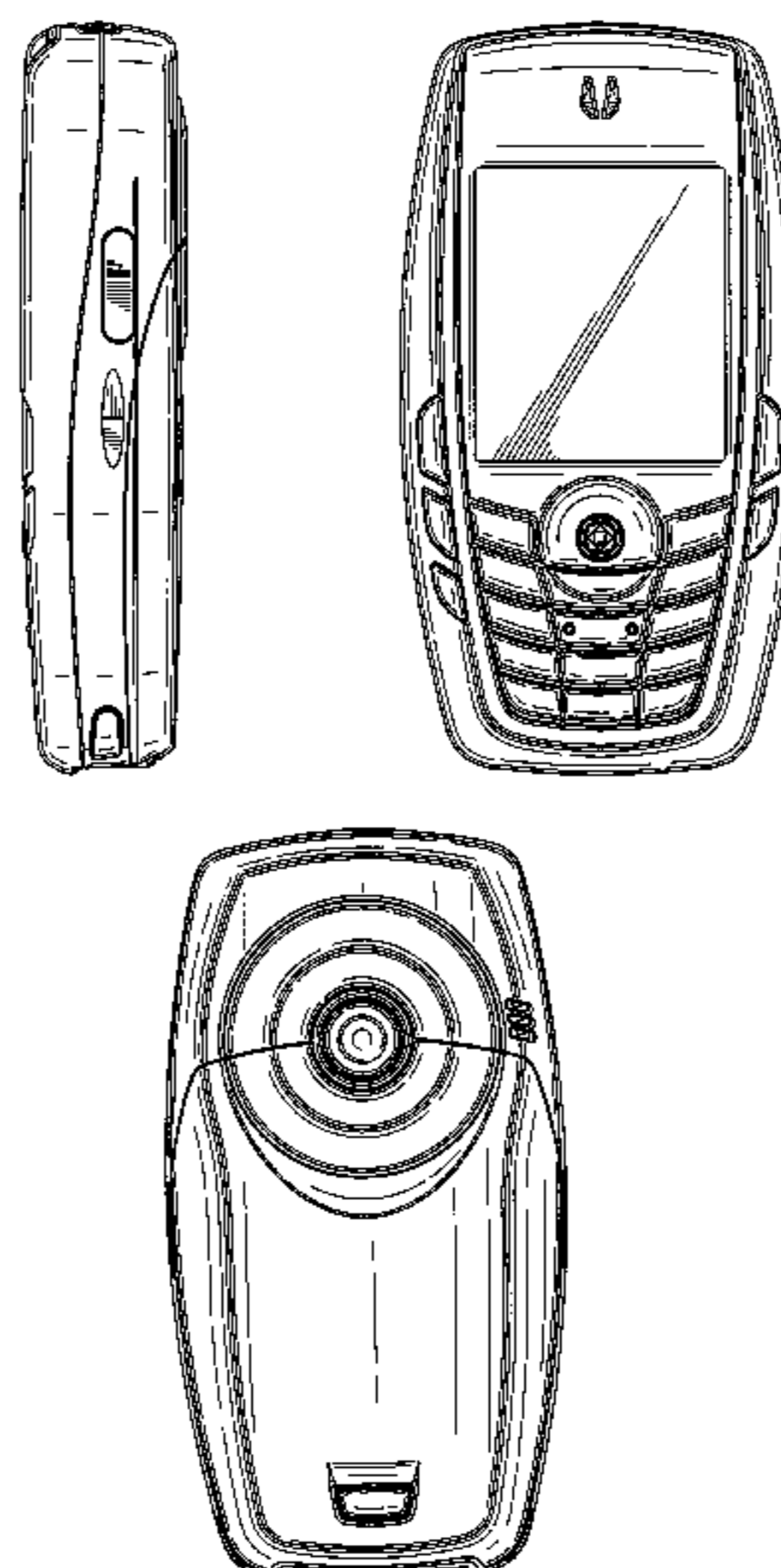

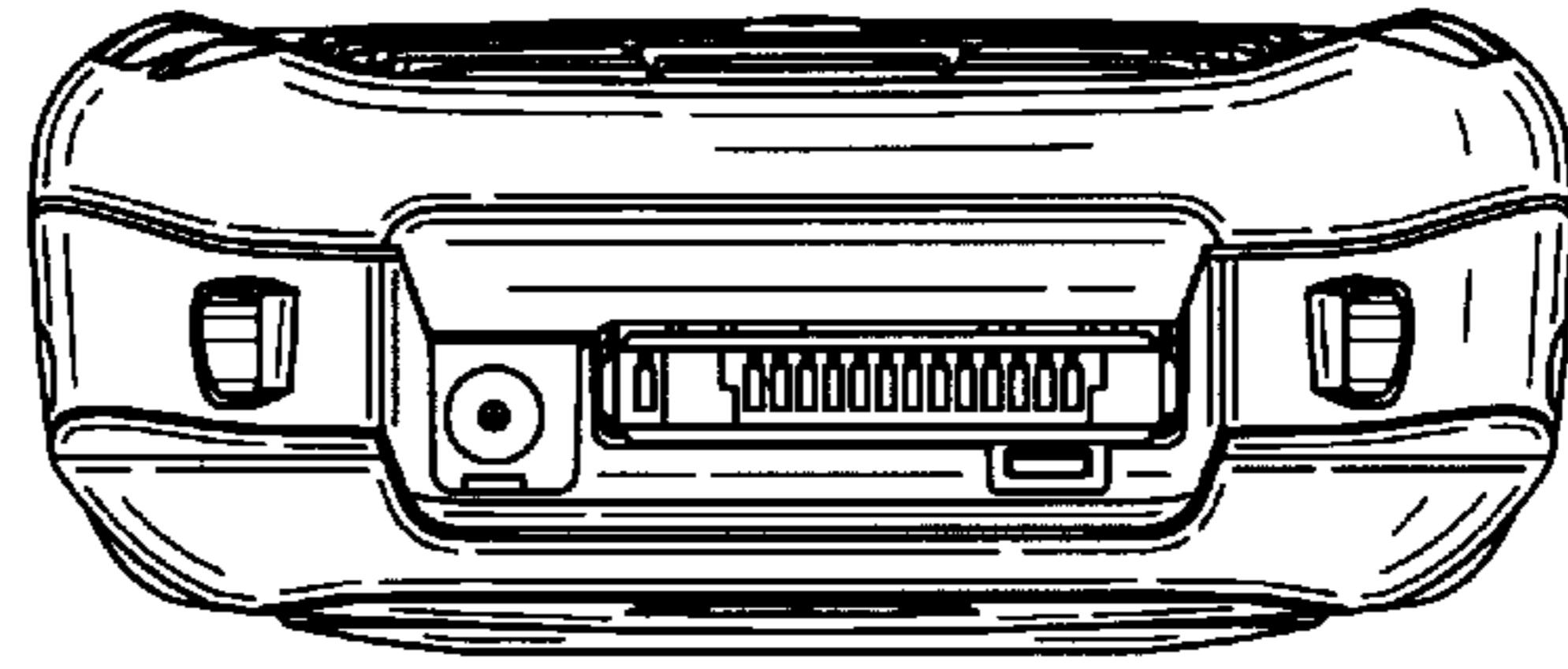

FIG. 1

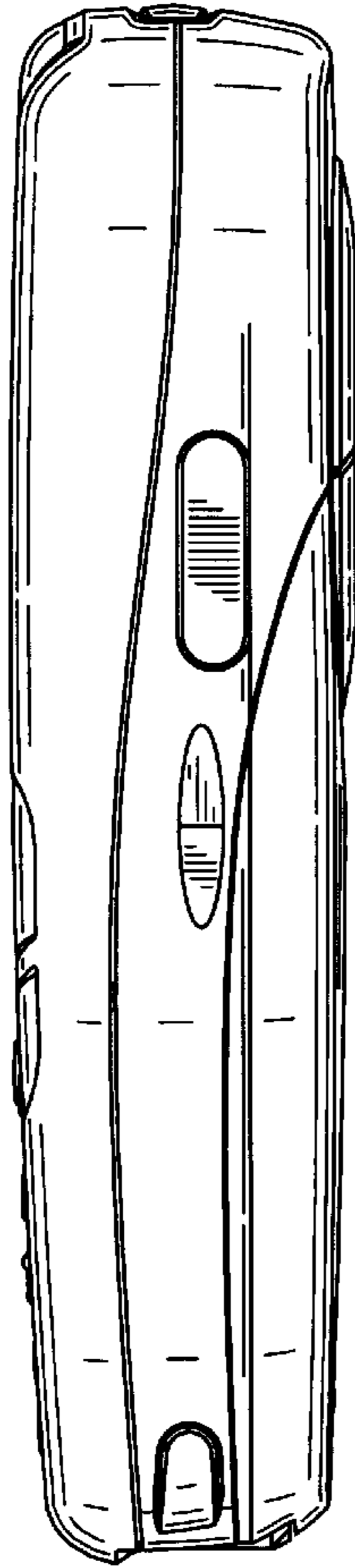

FIG. 2

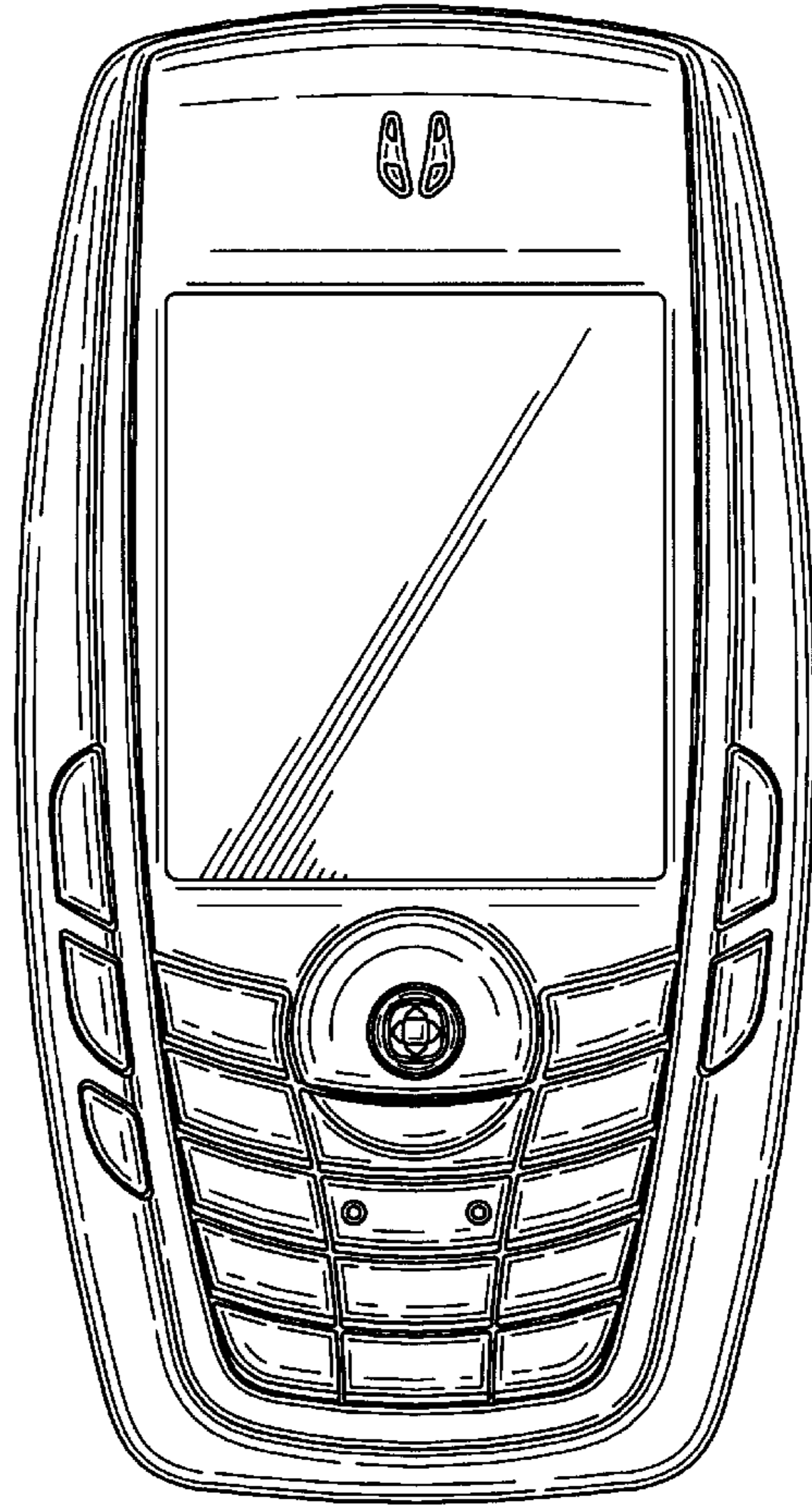

FIG. 3

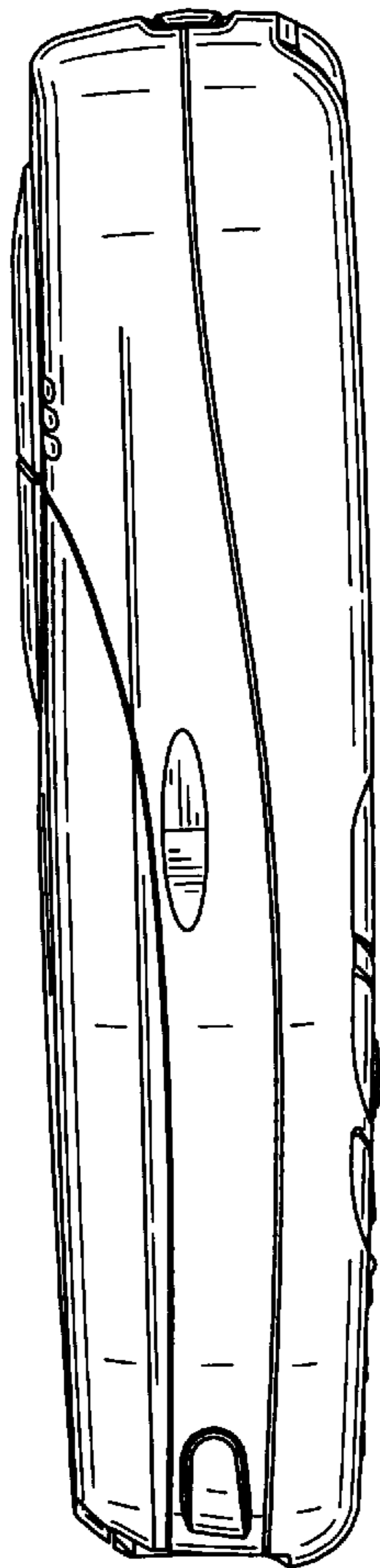

FIG. 4

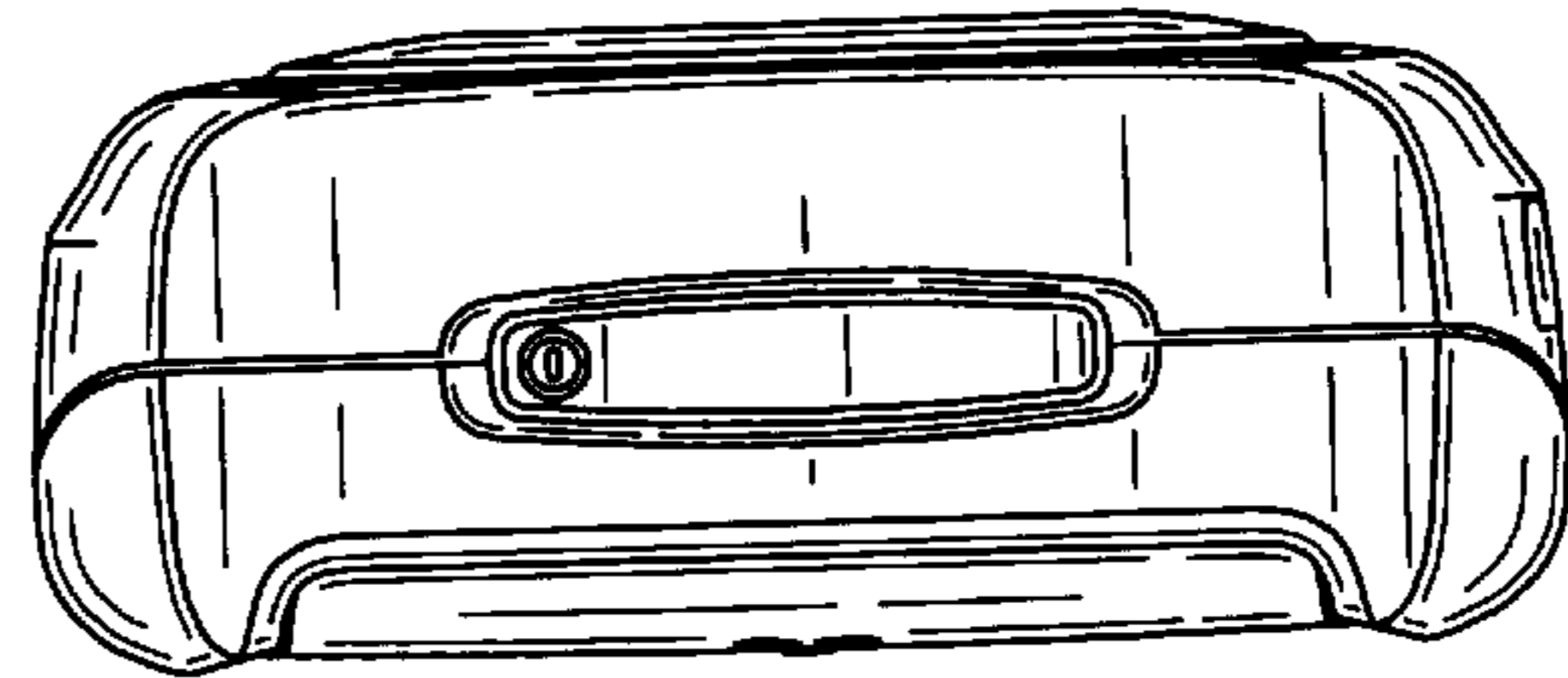

FIG. 5

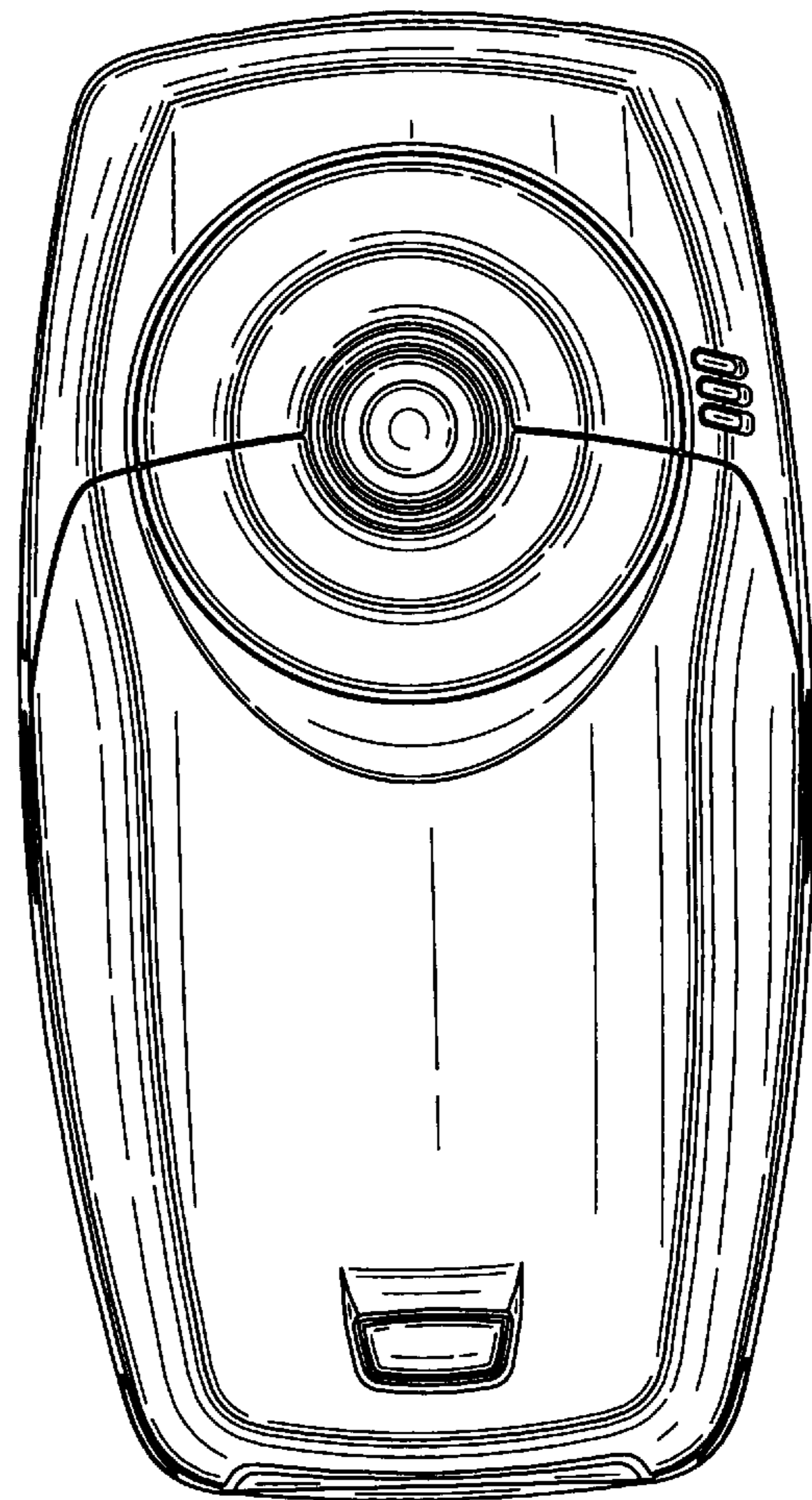

FIG. 6



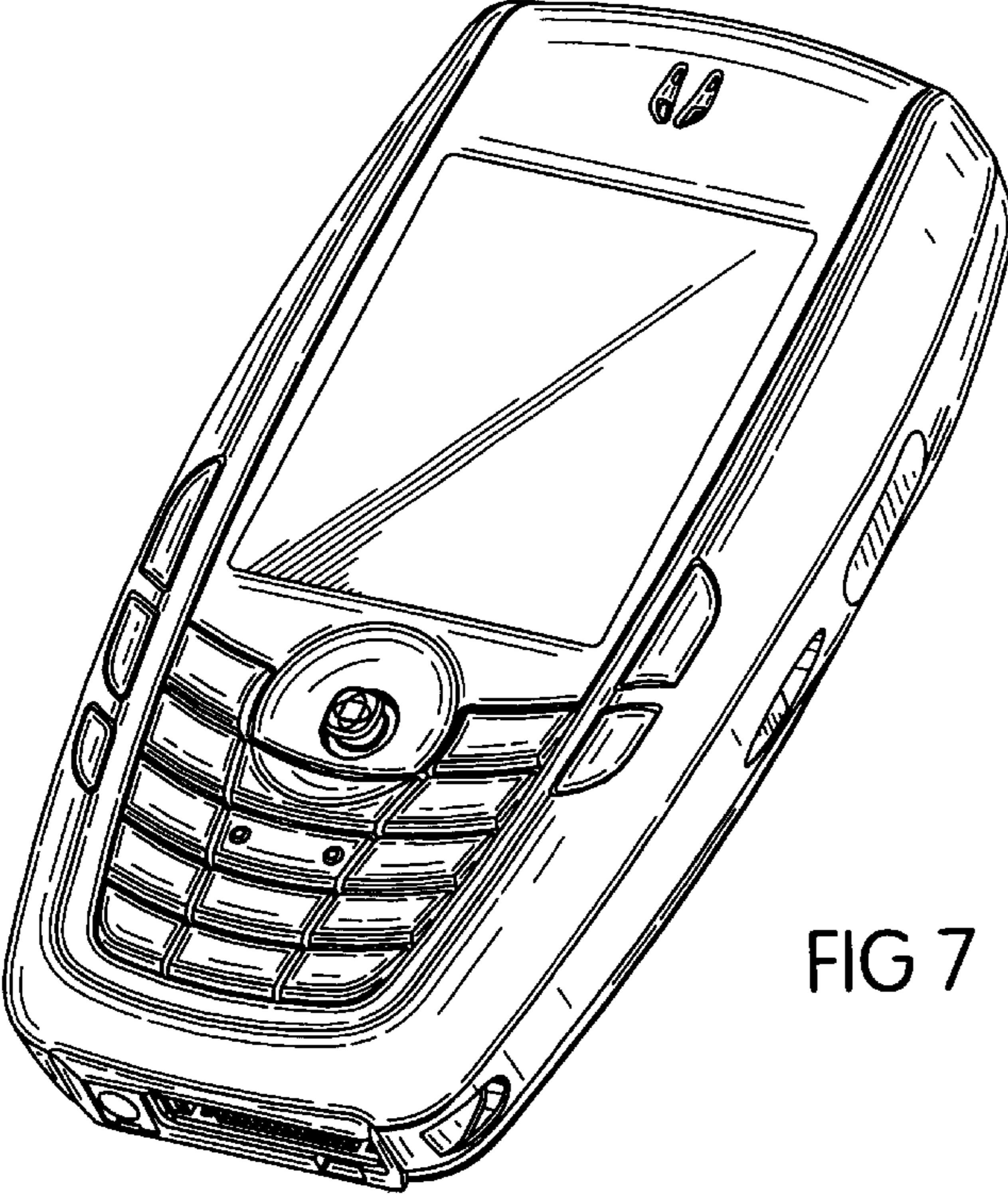

FIG 7

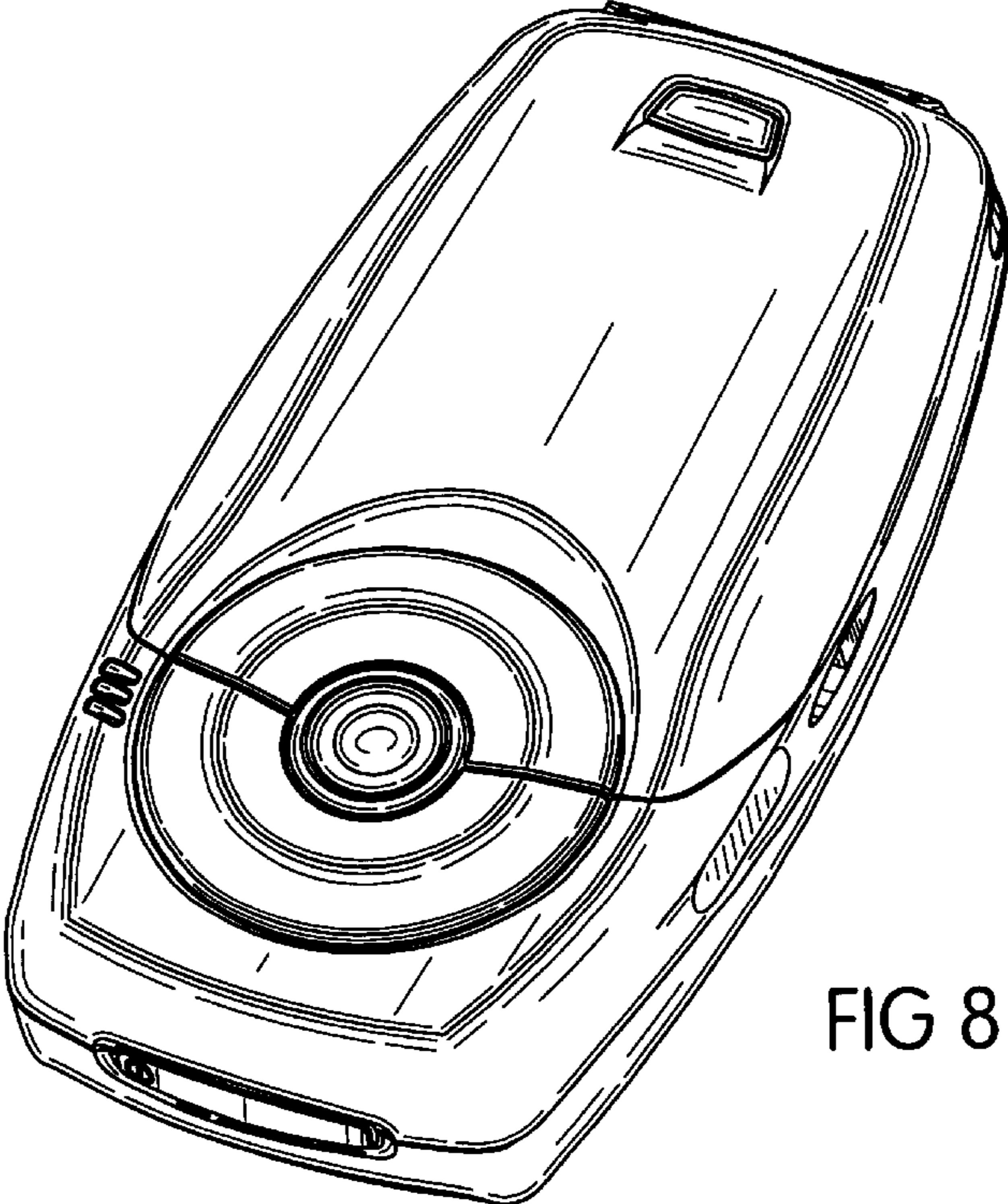

FIG 8

UNITED STATES PATENT AND TRADEMARK OFFICE  
**CERTIFICATE OF CORRECTION**

PATENT NO. : Des. 494,561 S  
DATED : August 17, 2004  
INVENTOR(S) : Junichi Kagami et al.

Page 1 of 1

It is certified that error appears in the above-identified patent and that said Letters Patent is hereby corrected as shown below:

Title page,

Item [56], **References Cited**, U.S. PATENT DOCUMENTS,

“D485,482 S” has been replaced with -- D465,482 S --

“D484,885 S” has been replaced with -- D484,865 S --

Signed and Sealed this

Fourteenth Day of December, 2004

A handwritten signature in black ink that reads "Jon W. Dudas". The signature is written in a cursive style with a large, stylized initial "J" and "D".

JON W. DUDAS

*Director of the United States Patent and Trademark Office*