

US00D494529S1

(12) **United States Design Patent** (10) **Patent No.:** **US D494,529 S**
Cassell et al. (45) **Date of Patent:** **** Aug. 17, 2004**

(54) **SELECTED ELEMENTS OF A PERSONAL WATERCRAFT**

D342,352 S 12/1993 Schoell et al.
D343,160 S * 1/1994 LaPointe D12/307
D359,469 S * 6/1995 Yoshida et al. D12/307

(75) Inventors: **Shannon Cassell**, Palm Bay, FL (US);
Tom Bucaccio, Grant, FL (US); **Kirk Aguero**, Indialantic, FL (US); **Greg Martin**, Melbourne Beach, FL (US);
Rick Adameczyk, St.Cloud, FL (US)

OTHER PUBLICATIONS

Carver Yachts Catalog, no page number, personal watercraft located left, 1998 (copy in Examiner Baynham's office).

(73) Assignee: **Bombardier Recreational Products Inc.**, St-Bruno (CA)

* cited by examiner

Primary Examiner—Holly Baynham
(74) *Attorney, Agent, or Firm*—BRP Legal Services

(**) Term: **14 Years**

(57) **CLAIM**

(21) Appl. No.: **29/185,485**

The ornamental design for selected elements of a personal watercraft, as shown and described.

(22) Filed: **Jun. 30, 2003**

DESCRIPTION

Related U.S. Application Data

(62) Division of application No. 29/161,065, filed on May 23, 2002, now Pat. No. Des. 479,702.

FIG. 1 is a perspective illustration, from the front and right side, of selected elements of a personal watercraft according to our design;
FIG. 2 is a front view thereof;
FIG. 3 is a rear view thereof;
FIG. 4 is a left side view thereof;
FIG. 5 is a right side view thereof; and,
FIG. 6 is a top view thereof.

(51) **LOC (7) Cl.** **12-06**

(52) **U.S. Cl.** **D12/307**

(58) **Field of Search** D12/300, 307;
114/55.54, 55.55, 55.57, 270-271

Throughout FIGS. 1-6, broken lines showing structure are for illustrative purposes only and form no part of the claimed design.

(56) **References Cited**

U.S. PATENT DOCUMENTS

D340,221 S * 10/1993 Krieger et al. D12/307
D342,052 S * 12/1993 Schoell et al. D12/307

1 Claim, 5 Drawing Sheets

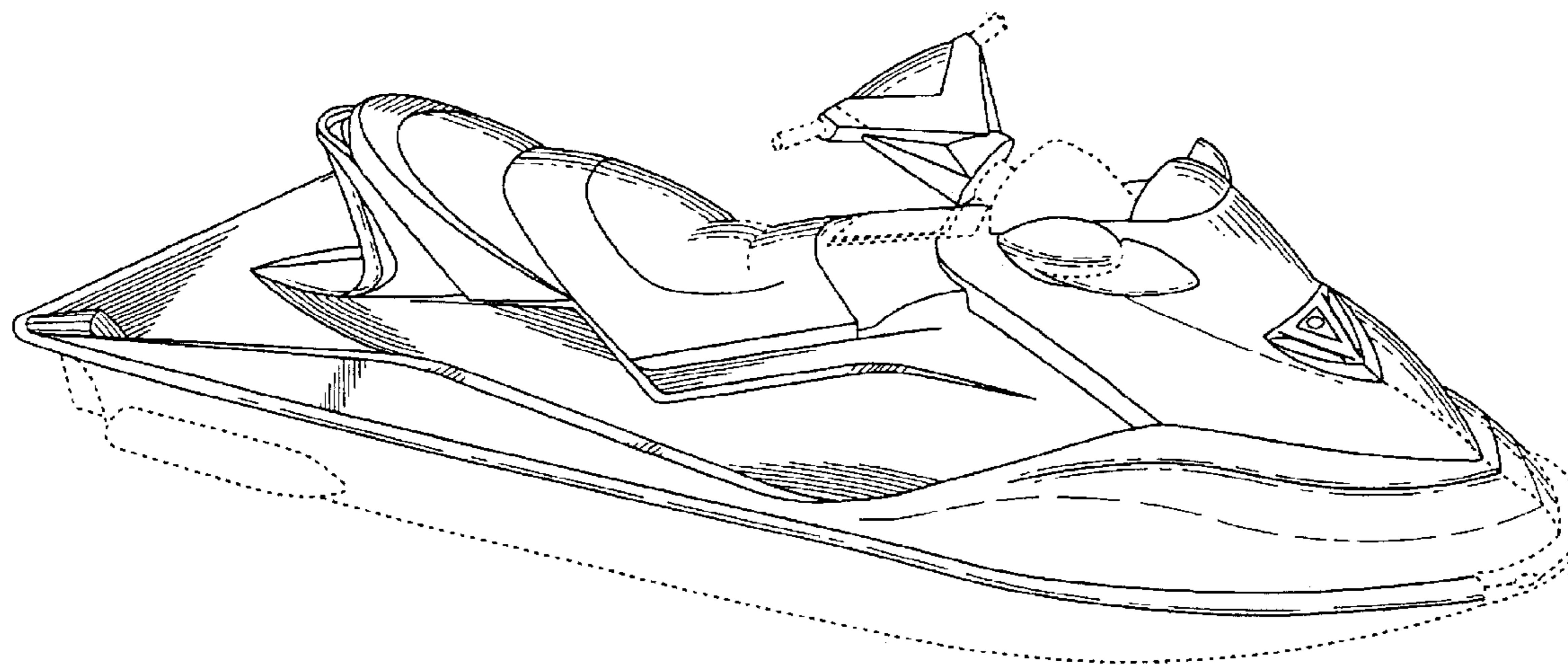

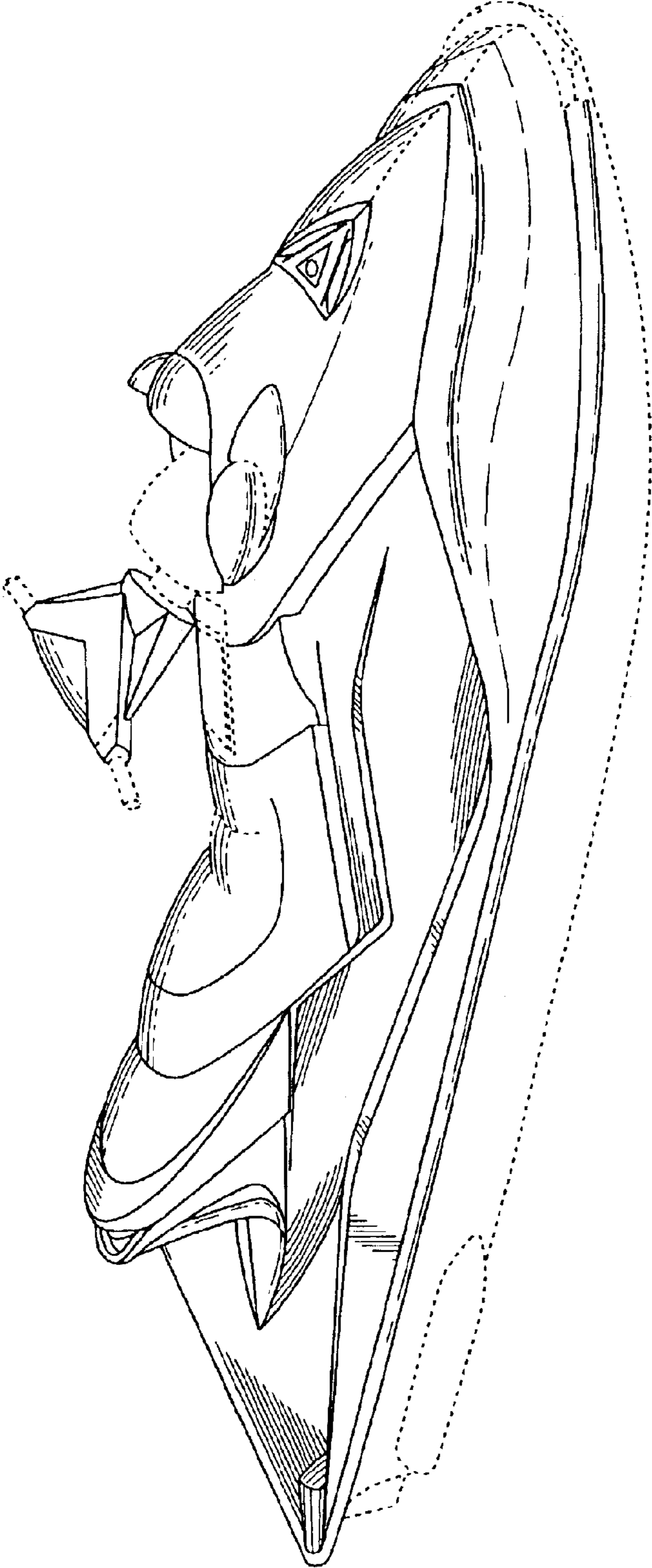

FIG. 1

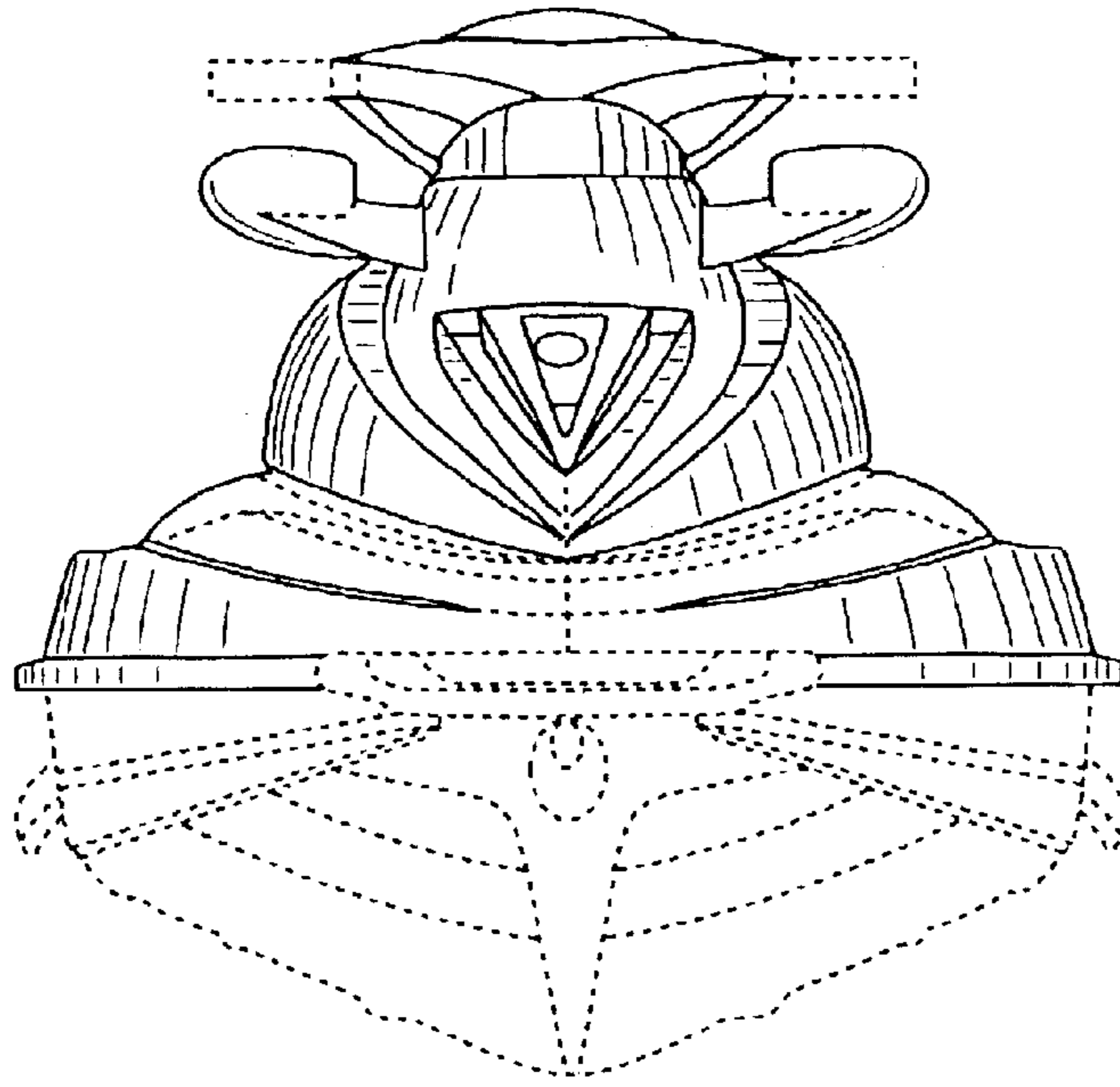

FIG. 2

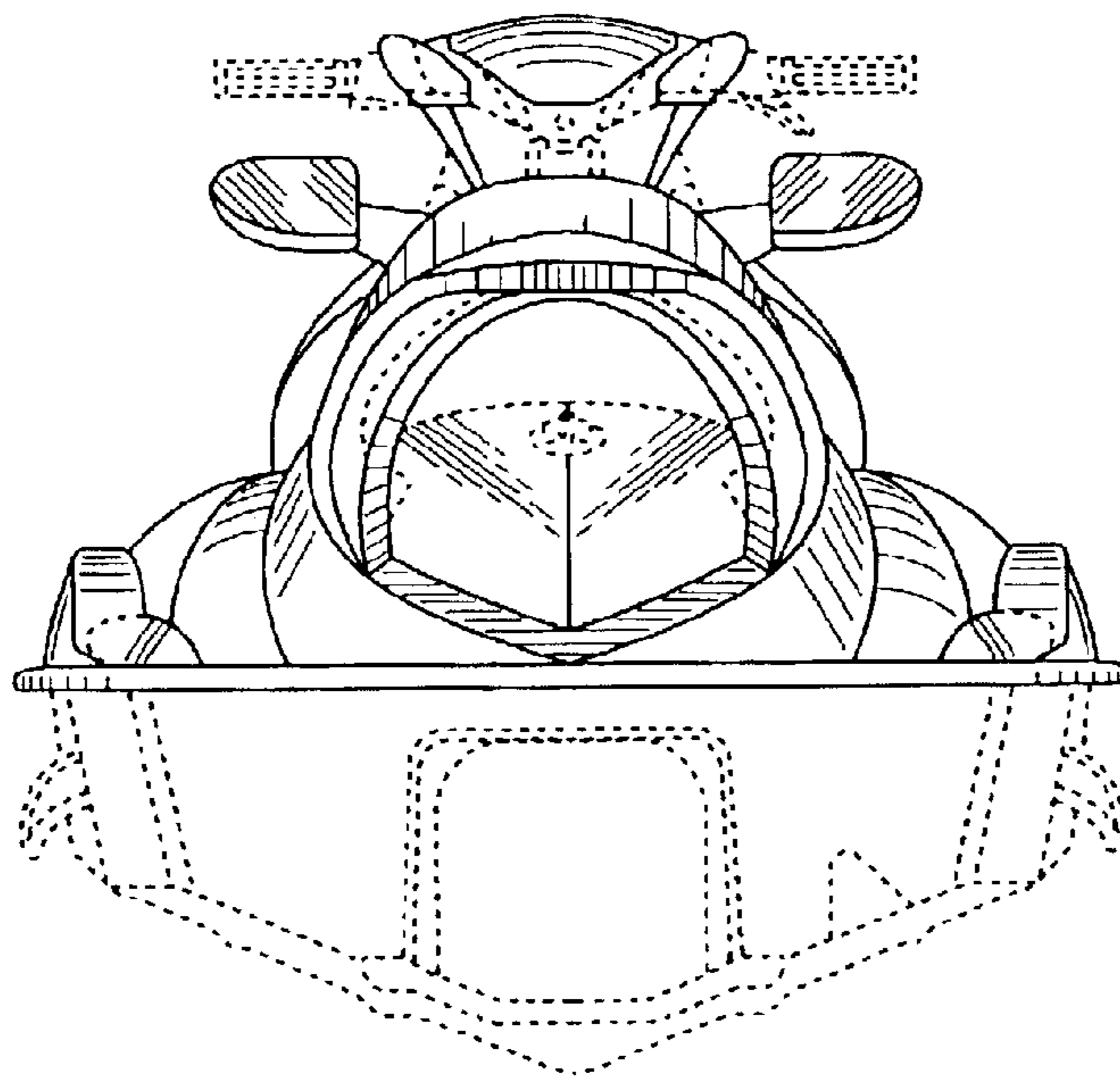

FIG. 3

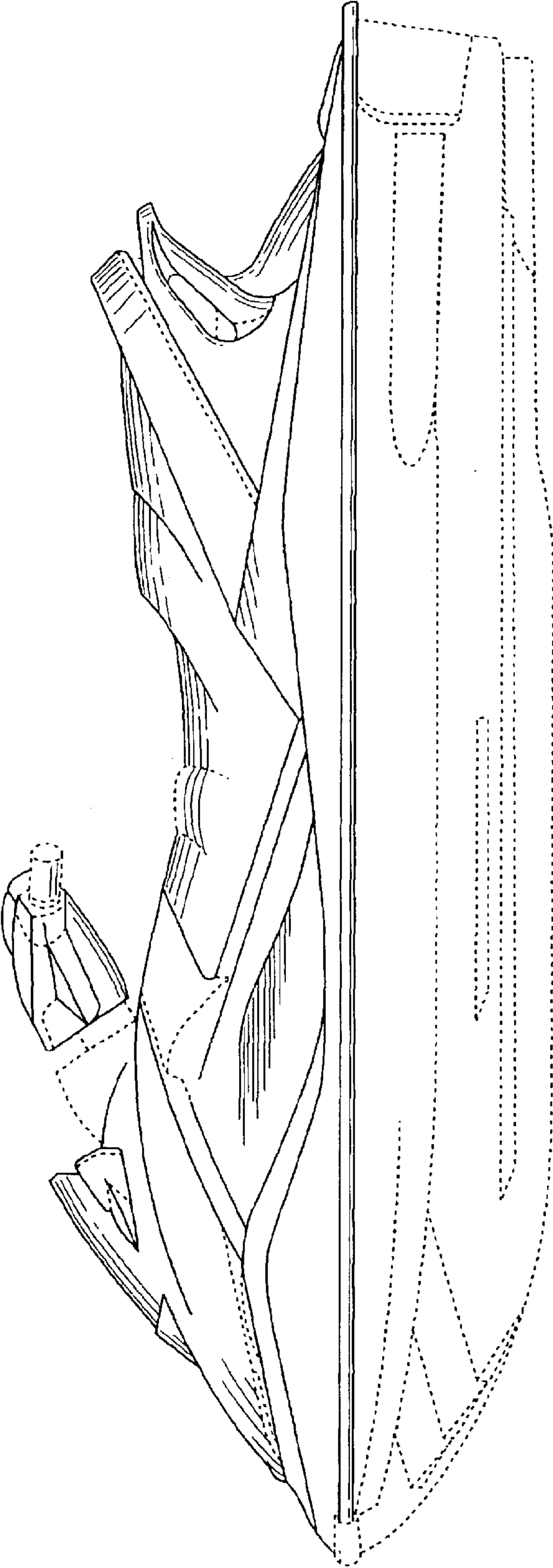

FIG. 4

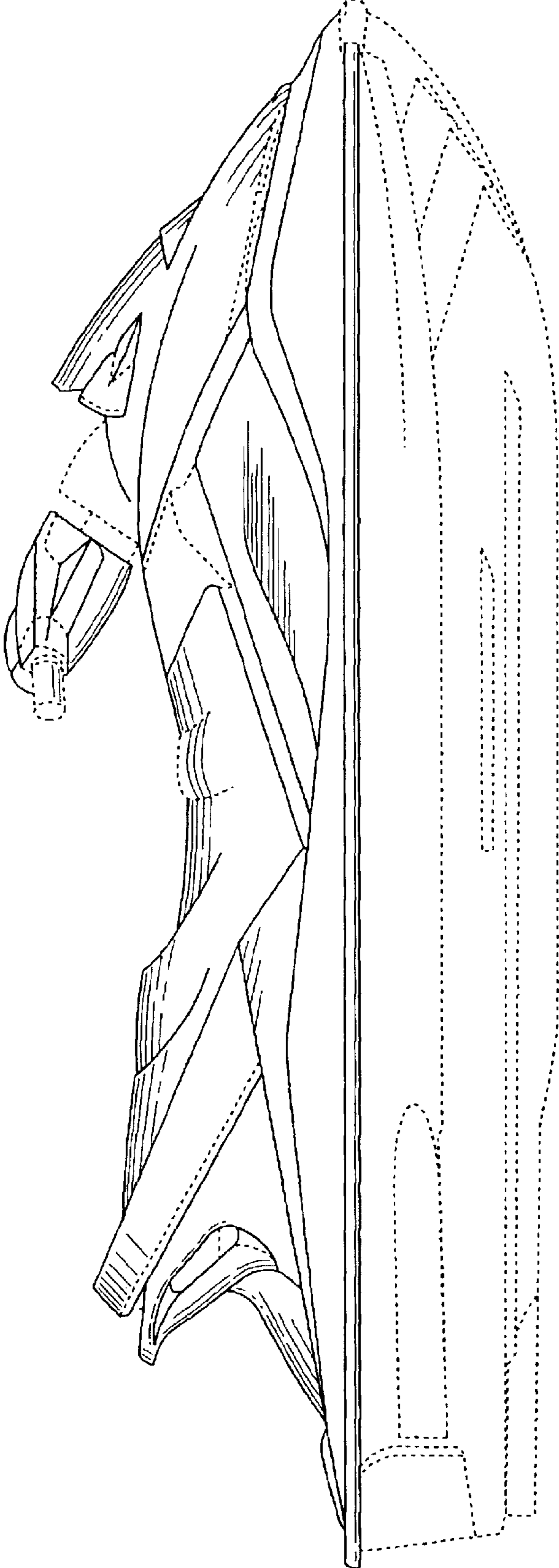

FIG. 5

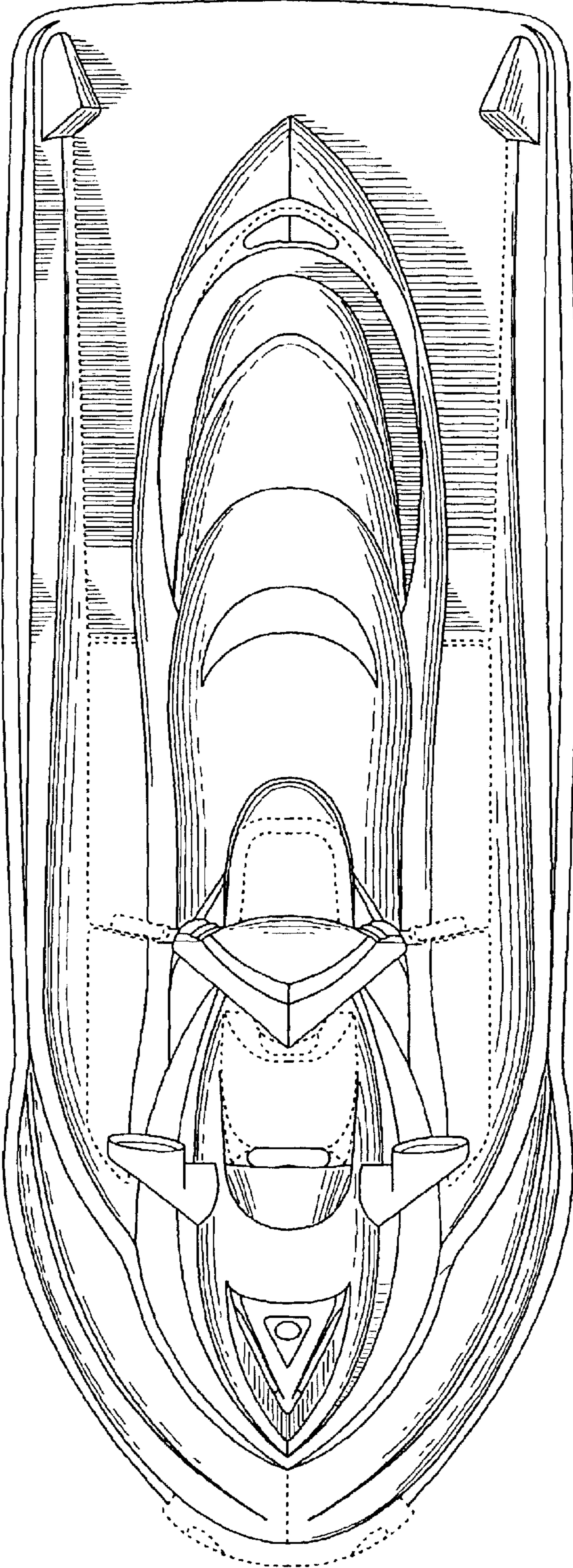

FIG. 6