

US00D494409S1

(12) **United States Design Patent**
Khubani

(10) **Patent No.:** **US D494,409 S**

(45) **Date of Patent:** **** Aug. 17, 2004**

(54) **THAW TRAY**

(75) **Inventor:** **Anand V. Khubani**, Montville, NJ (US)

(73) **Assignee:** **Ideavillage, LLC.**, Fairfield, NJ (US)

(**) **Term:** **14 Years**

(21) **Appl. No.:** **29/173,791**

(22) **Filed:** **Jan. 7, 2003**

(51) **LOC (7) Cl.** **07-02**

(52) **U.S. Cl.** **D7/363**

(58) **Field of Search** D7/323, 332-337,
D7/354, 402-404; 126/25 R, 25 A, 25 AA,
38, 37 A, 41 R, 40; 99/450, 481-482, 445;
219/450.1, 443.1

(56) **References Cited**

U.S. PATENT DOCUMENTS

D204,197 S * 3/1966 Little D7/363
5,349,899 A * 9/1994 Tominaga et al. 99/646 R
5,368,093 A * 11/1994 Takehashi 165/46
D367,399 S * 2/1996 Brooks D7/368

D380,342 S * 7/1997 Edmonds D7/363
5,713,414 A * 2/1998 Ko 165/185
D394,584 S * 5/1998 Weber D7/363
6,601,642 B1 * 8/2003 Randall 165/86

* cited by examiner

Primary Examiner—Ruth McInroy

(74) *Attorney, Agent, or Firm*—Bazerman & Drangel P.C.

(57) **CLAIM**

The ornamental design for thaw tray, as shown and described.

DESCRIPTION

FIG. 1 is a perspective view of a thaw tray showing my new design;

FIG. 2 is a top plan view thereof;

FIG. 3 is a bottom plan view thereof;

FIG. 4 is a front view thereof;

FIG. 5 is a rear view thereof;

FIG. 6 is a right side view thereof; and,

FIG. 7 is a left side view thereof.

1 Claim, 4 Drawing Sheets

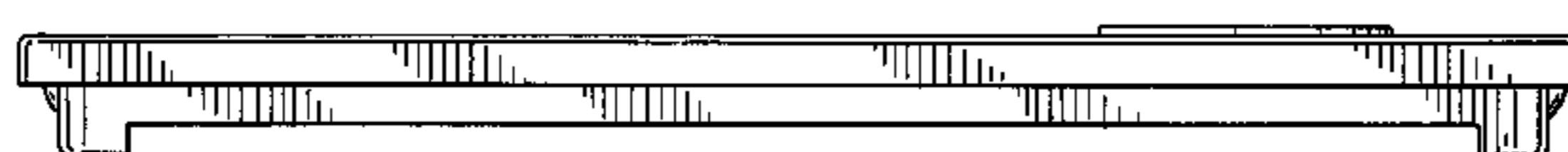
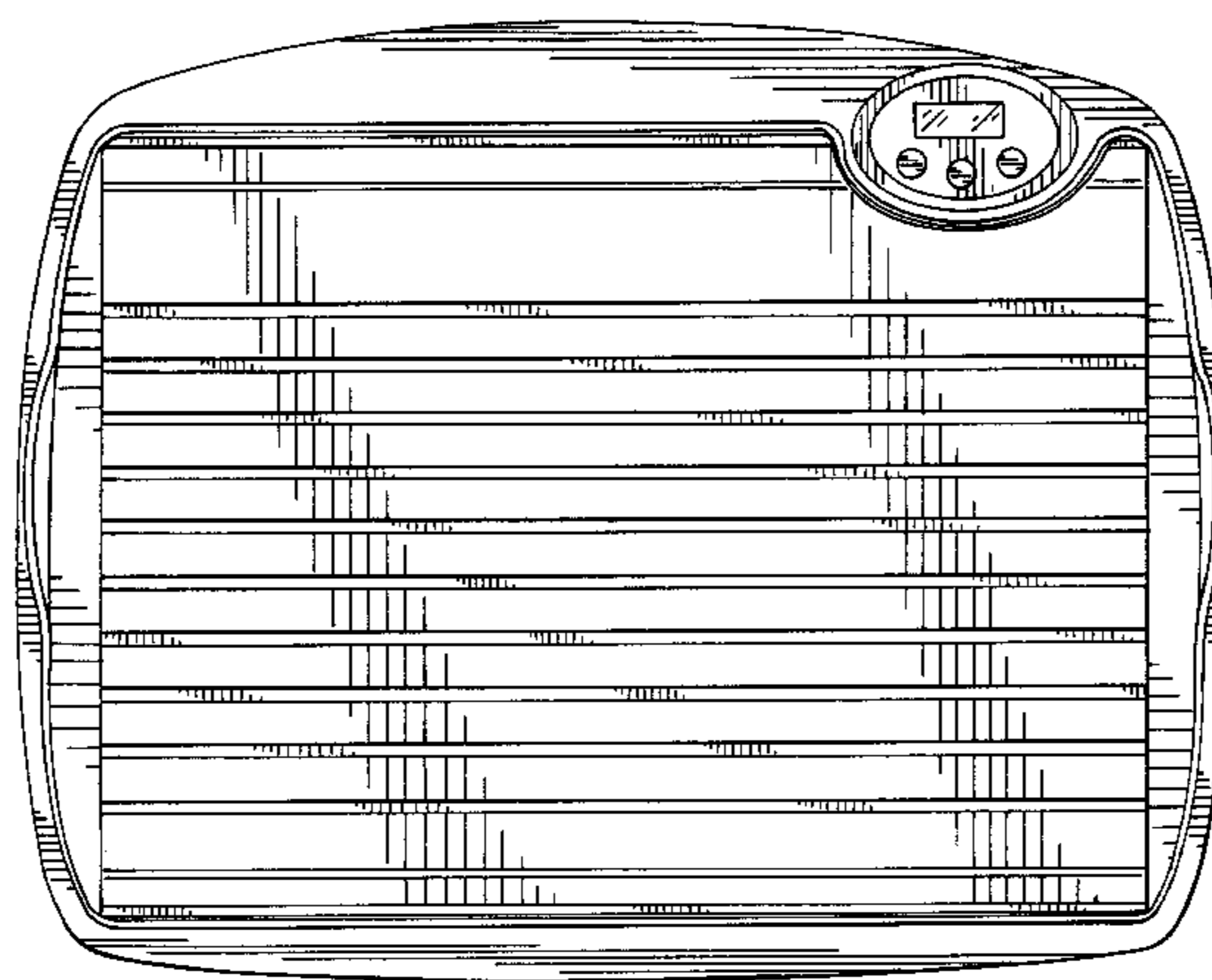
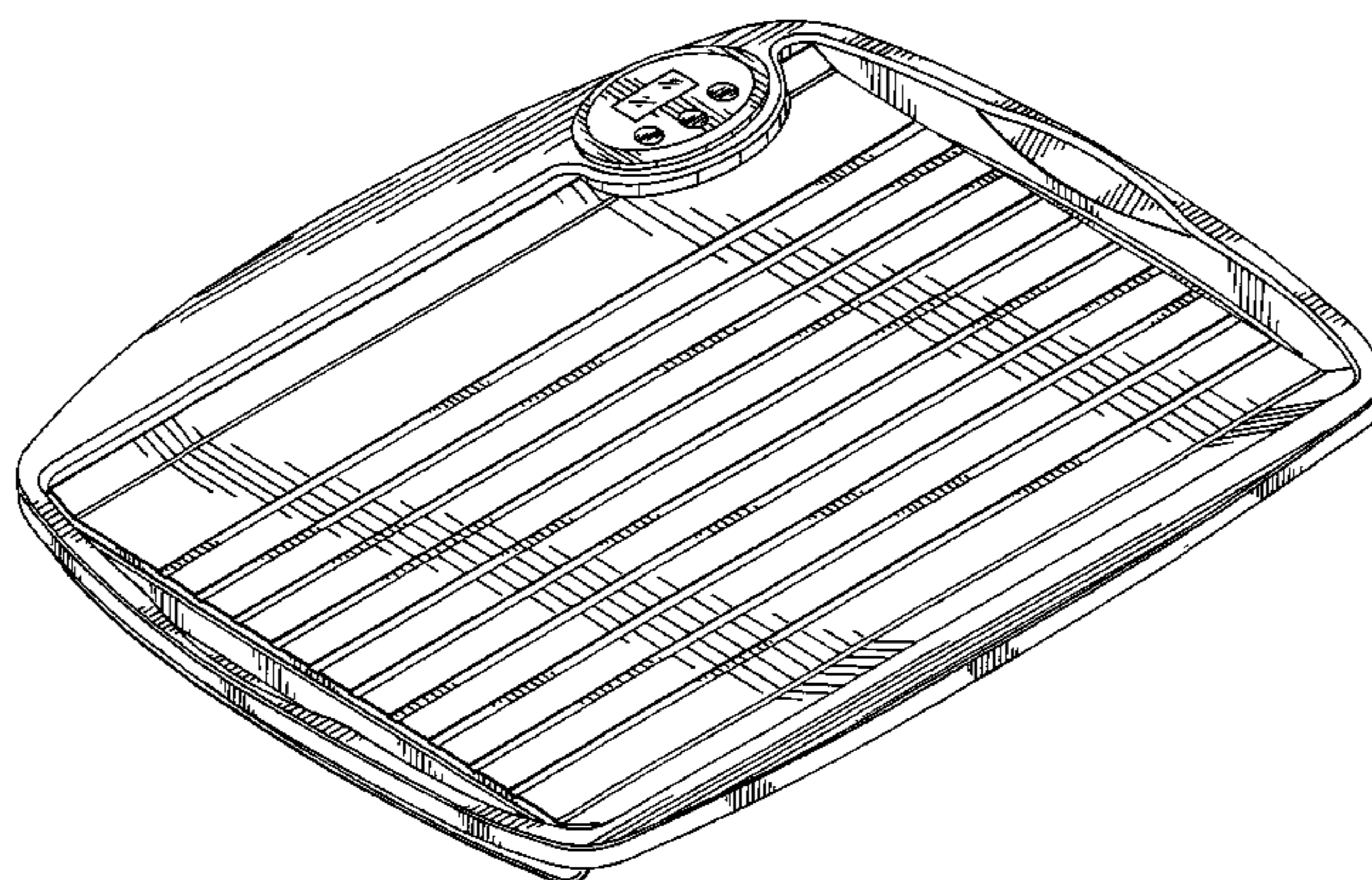

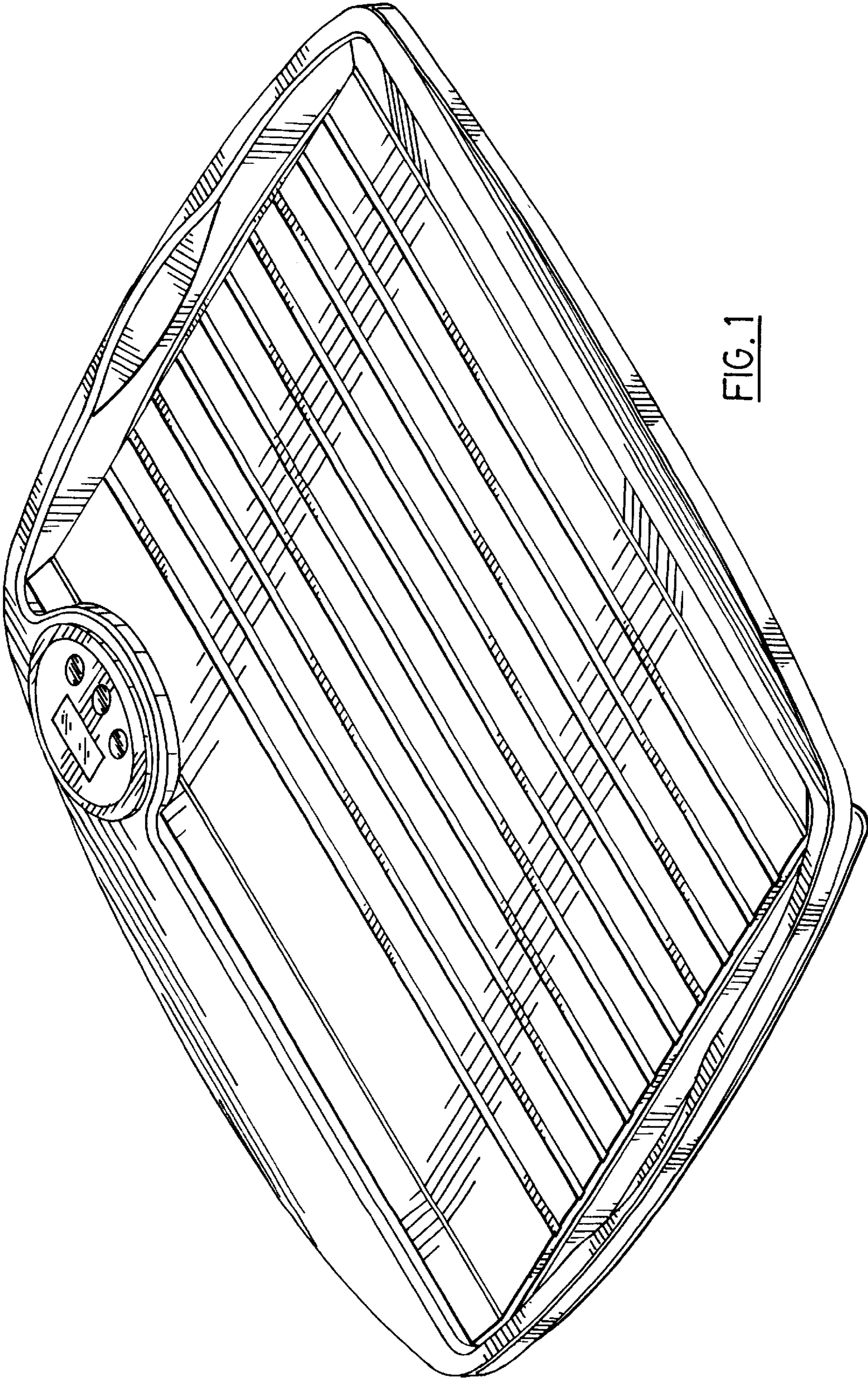

FIG. 1

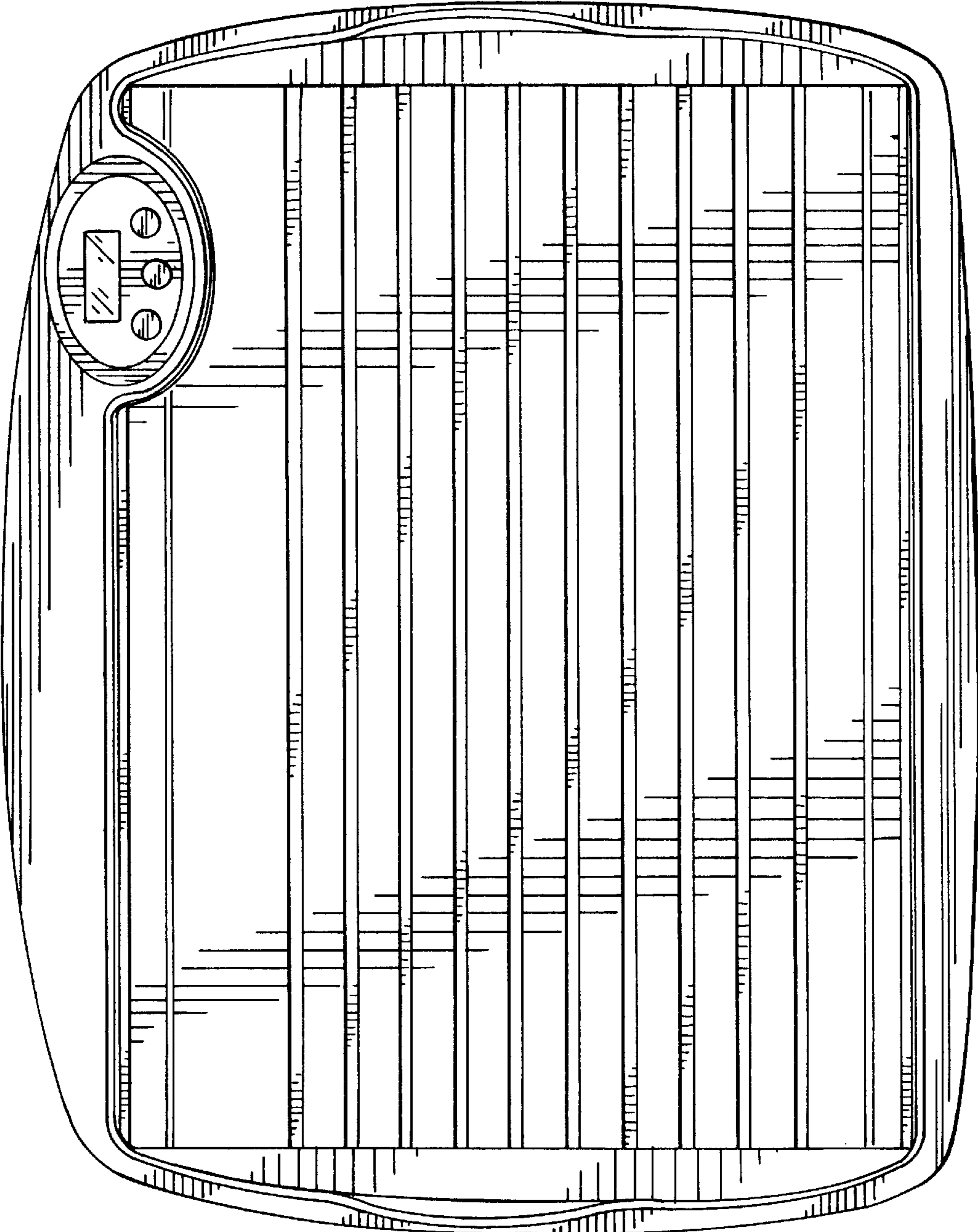

FIG. 2

FIG. 3

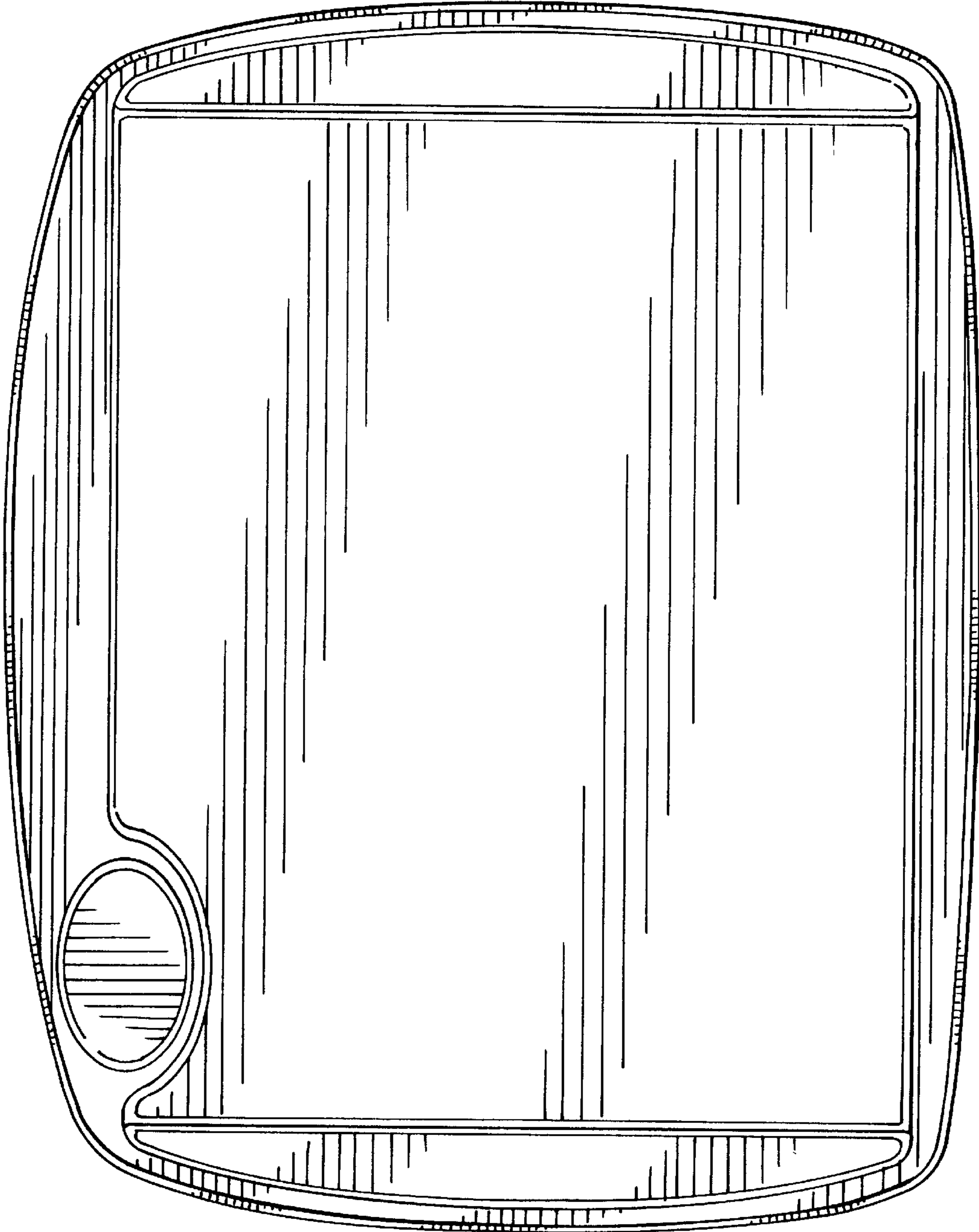



FIG. 4

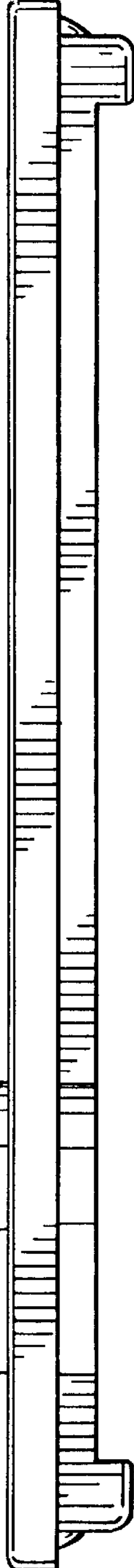

FIG. 5

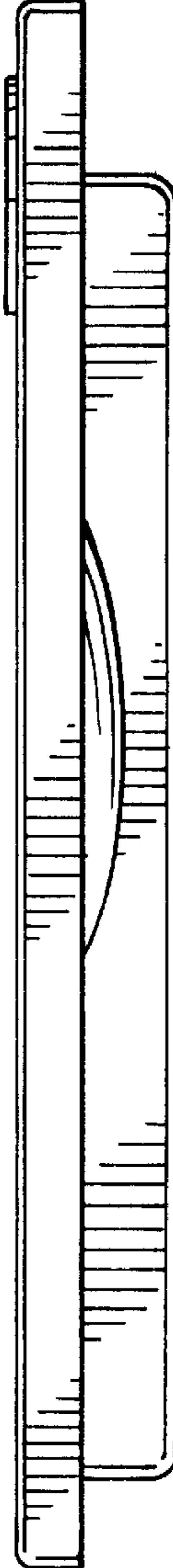

FIG. 6

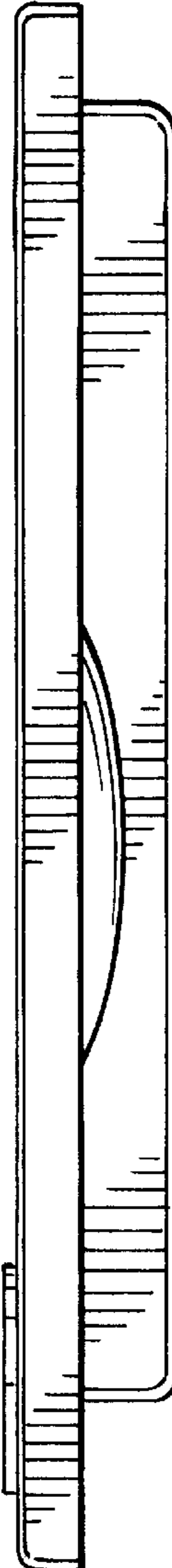

FIG. 7