



US00D494373S1

(12) **United States Design Patent** (10) **Patent No.:** **US D494,373 S**  
**Hancock** (45) **Date of Patent:** **\*\* Aug. 17, 2004**

(54) **SEAT**

(75) Inventor: **Matthew Bruce Hancock**, Lower Hutt (NZ)

(73) Assignee: **Cene Design Limited** (NZ)

(\*\*) Term: **14 Years**

(21) Appl. No.: **29/185,072**

(22) Filed: **Jun. 10, 2003**

(51) **LOC (7) Cl.** ..... **06-01**

(52) **U.S. Cl.** ..... **D6/334; D6/381**

(58) **Field of Search** ..... D6/334, 335, 371, D6/373, 379, 381, 500, 501, 502; 5/12.1; 297/445.1, 448.1, 232

(56) **References Cited**

**U.S. PATENT DOCUMENTS**

D95,745 S	*	5/1935	Hoffmann	.....	D6/379
D161,894 S	*	2/1951	Becker, Jr.	.....	D6/371
D282,418 S	*	2/1986	Lewis	.....	D6/381
D371,251 S	*	7/1996	Lewis	.....	D6/379
D448,191 S	*	9/2001	Kane	.....	D6/381 X
D477,721 S	*	7/2003	Conner	.....	D6/379

**OTHER PUBLICATIONS**

Howell catalog, p. 9, seating shown, May 19, 1941.\*

\* cited by examiner

*Primary Examiner*—Gary D. Watson

(74) *Attorney, Agent, or Firm*—Dann, Dorfman, Herrell and Skillman, P.C.

(57) **CLAIM**

The ornamental design for a seat, substantially as shown and described.

**DESCRIPTION**

FIG. 1 is a perspective view of a first embodiment of a seat in the form of a chair;

FIG. 2 is a front view thereof;

FIG. 3 is a rear view thereof;

FIG. 4 is a left hand side elevational view thereof, the right hand side being a mirror image thereof;

FIG. 5 is a perspective view of a second embodiment of a seat in the form of a two seater sofa;

FIG. 6 is a front view thereof;

FIG. 7 is a rear view thereof;

FIG. 8 is a left hand side elevational view thereof, the right hand side being a mirror image thereof;

FIG. 9 is a perspective view of a third embodiment of a seat in the form of a three seater sofa;

FIG. 10 is a front view thereof;

FIG. 11 is a rear view thereof;

FIG. 12 is a left hand side elevational view thereof, the right hand side being a mirror image thereof;

FIG. 13 is a perspective view of a fourth embodiment of a seat in the form of a chair;

FIG. 14 is a front view thereof;

FIG. 15 is a rear view thereof;

FIG. 16 is a left hand side elevational view thereof, the right hand side being a mirror image thereof;

FIG. 17 is a perspective view of a fifth embodiment of a seat in the form of a two seater sofa;

FIG. 18 is a front view thereof;

FIG. 19 is a rear view thereof;

FIG. 20 is a left hand side elevational view thereof, the right hand side being a mirror image thereof;

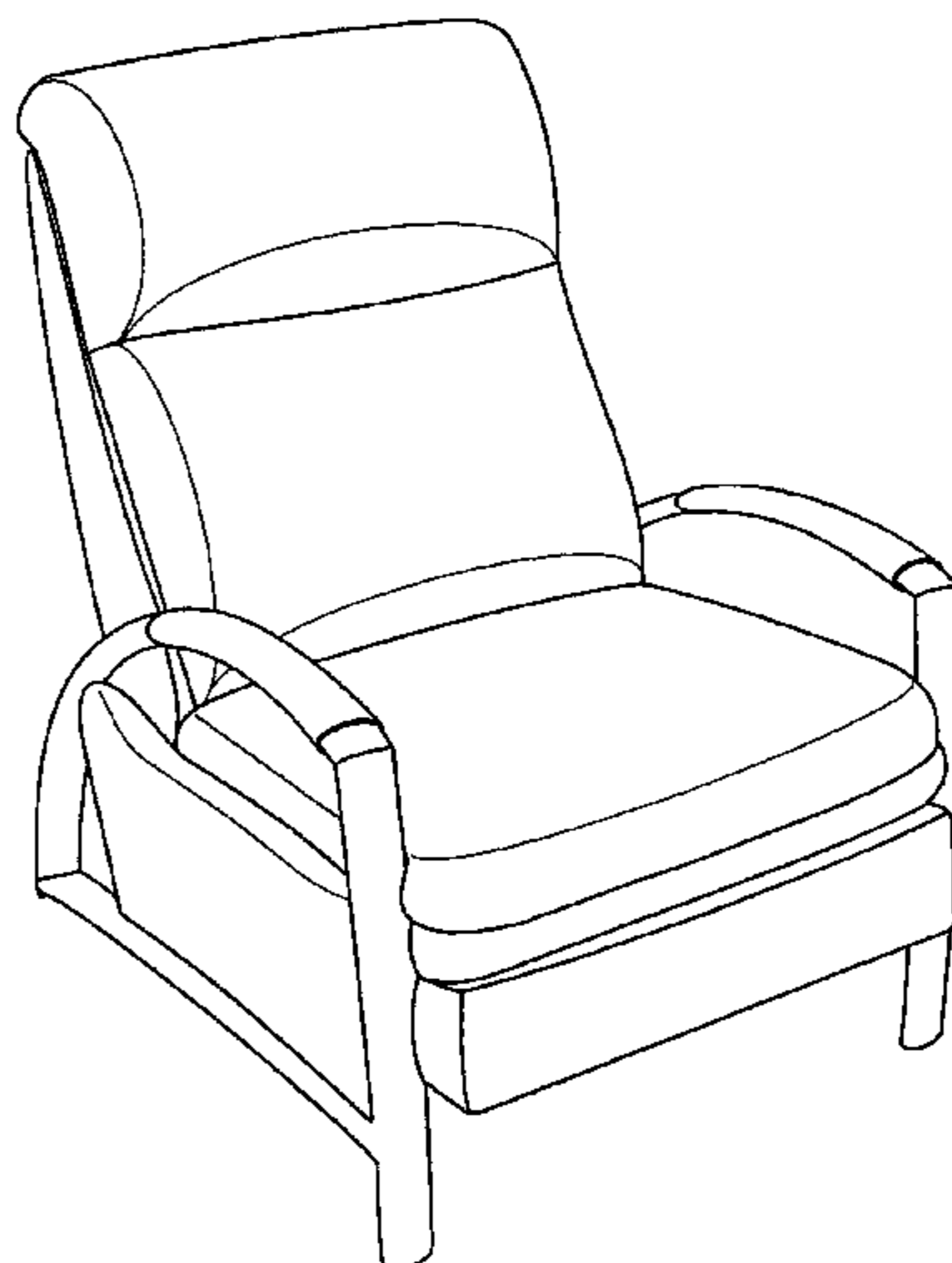
FIG. 21 is a perspective view of a sixth embodiment of a seat in the form of a three seater sofa;

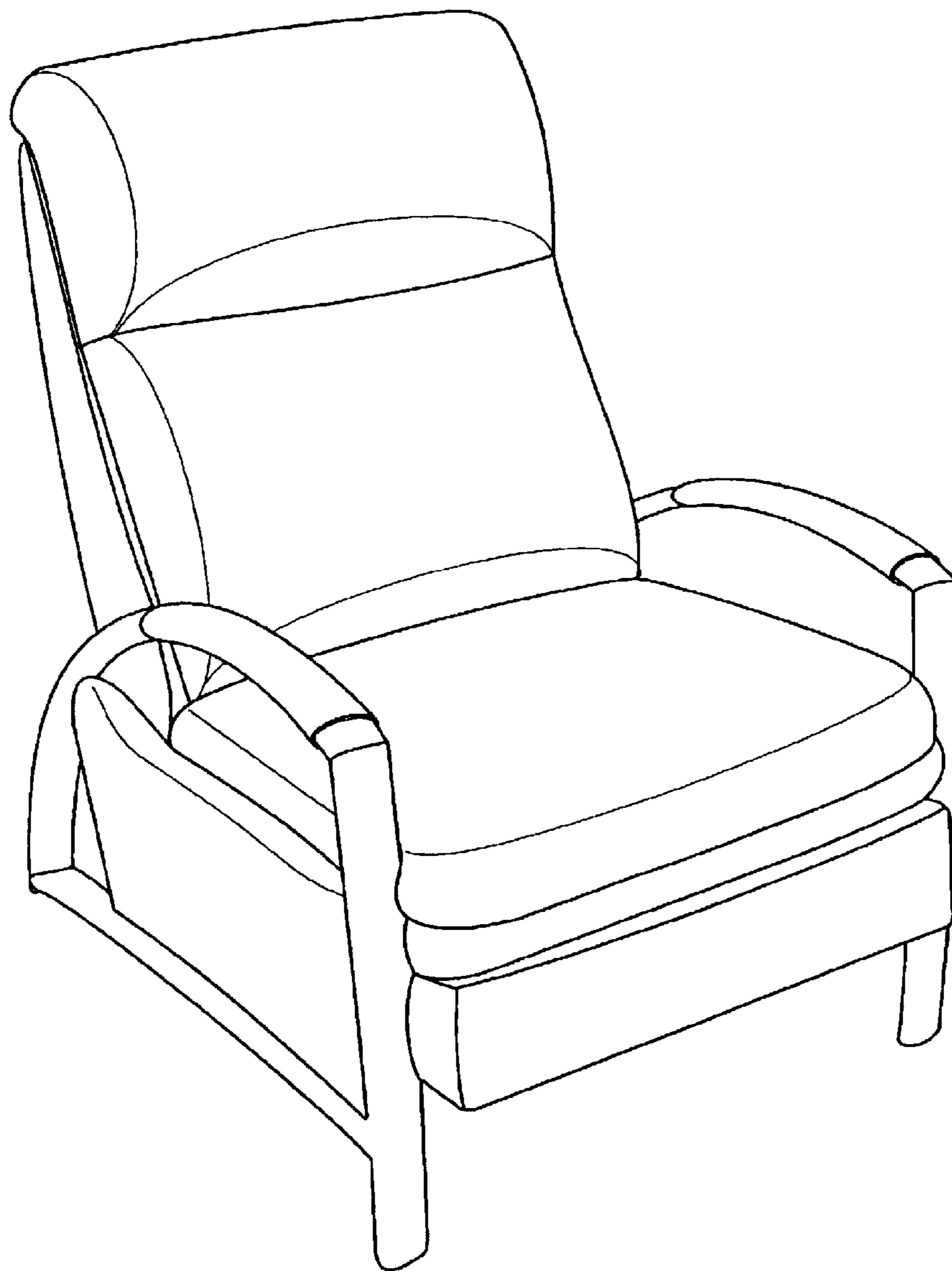
FIG. 22 is a front view thereof;

FIG. 23 is a rear view thereof; and,

FIG. 24 is a left hand side elevational view thereof, the right hand side being a mirror image thereof.

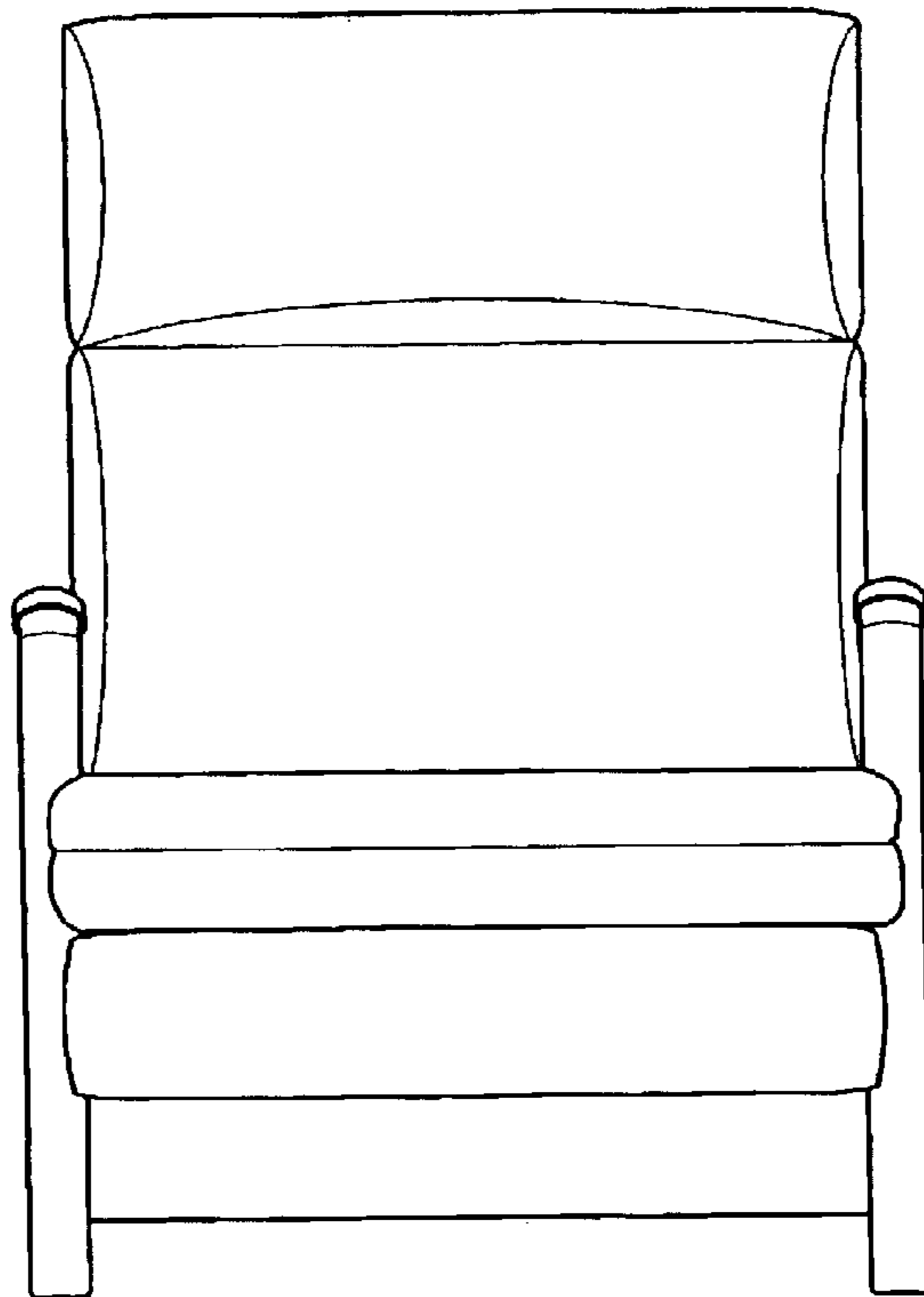
**1 Claim, 20 Drawing Sheets**



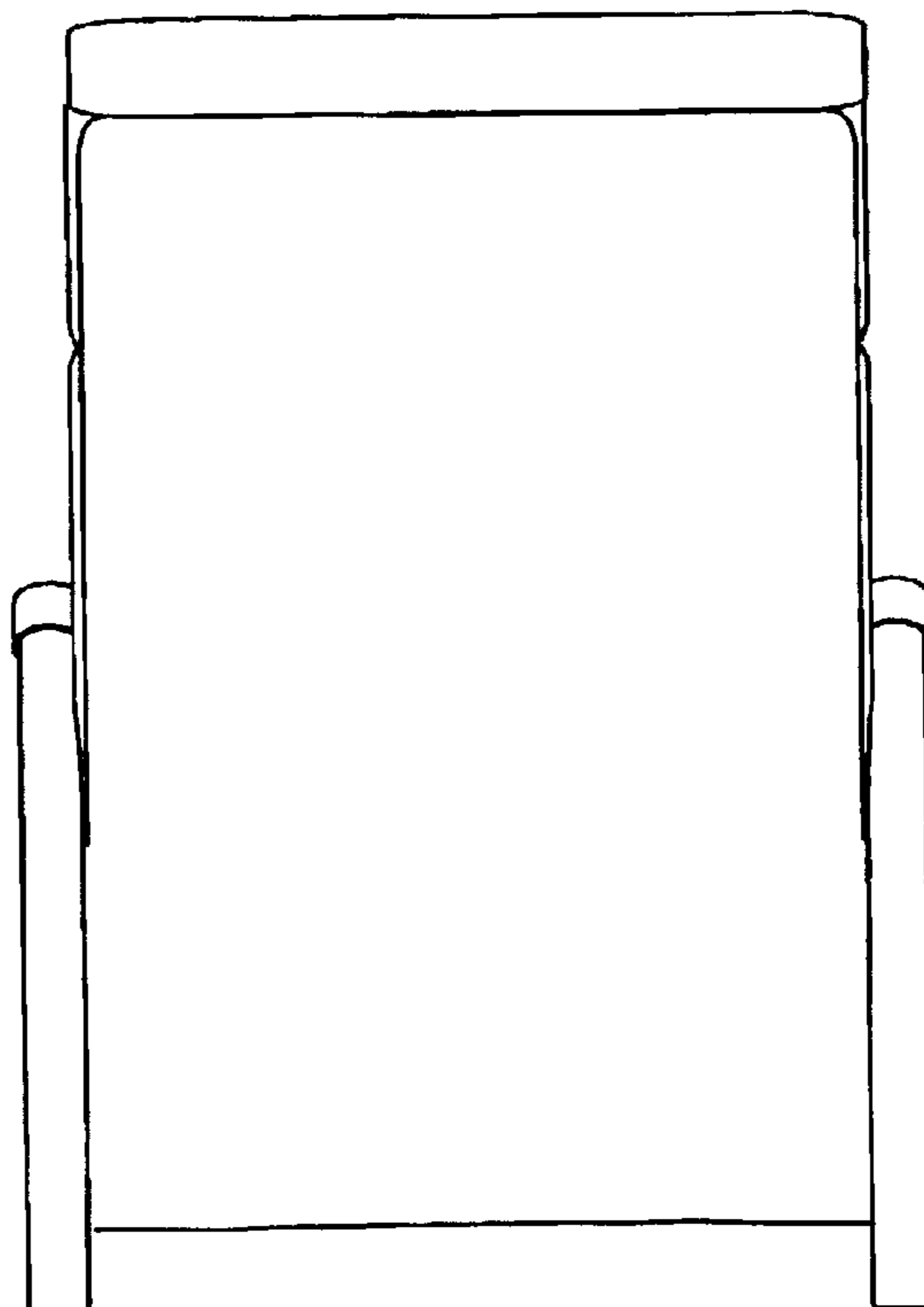


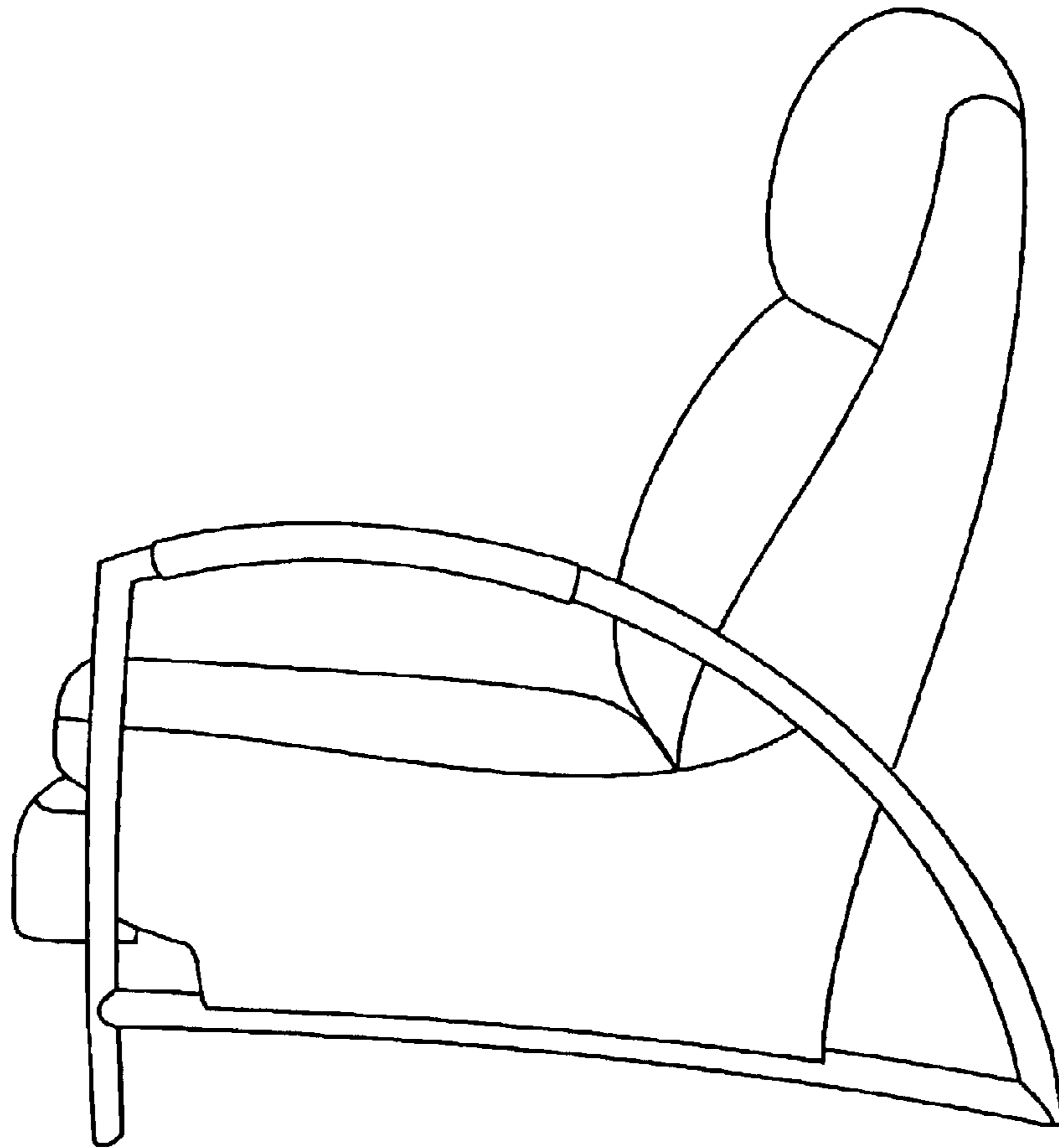
**FIGURE 1**

**FIGURE 2**



**FIGURE 3**





**FIGURE 4**

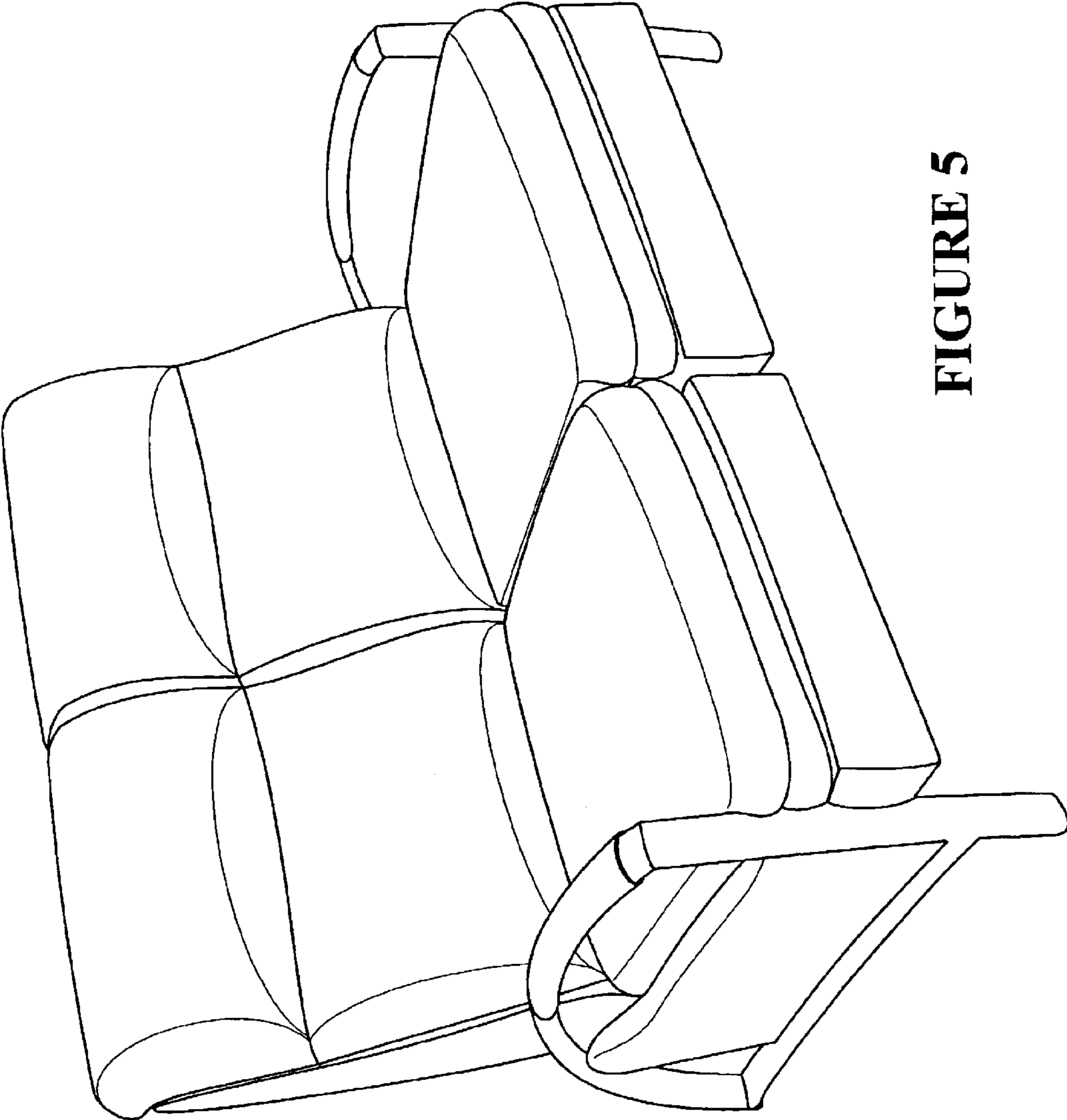
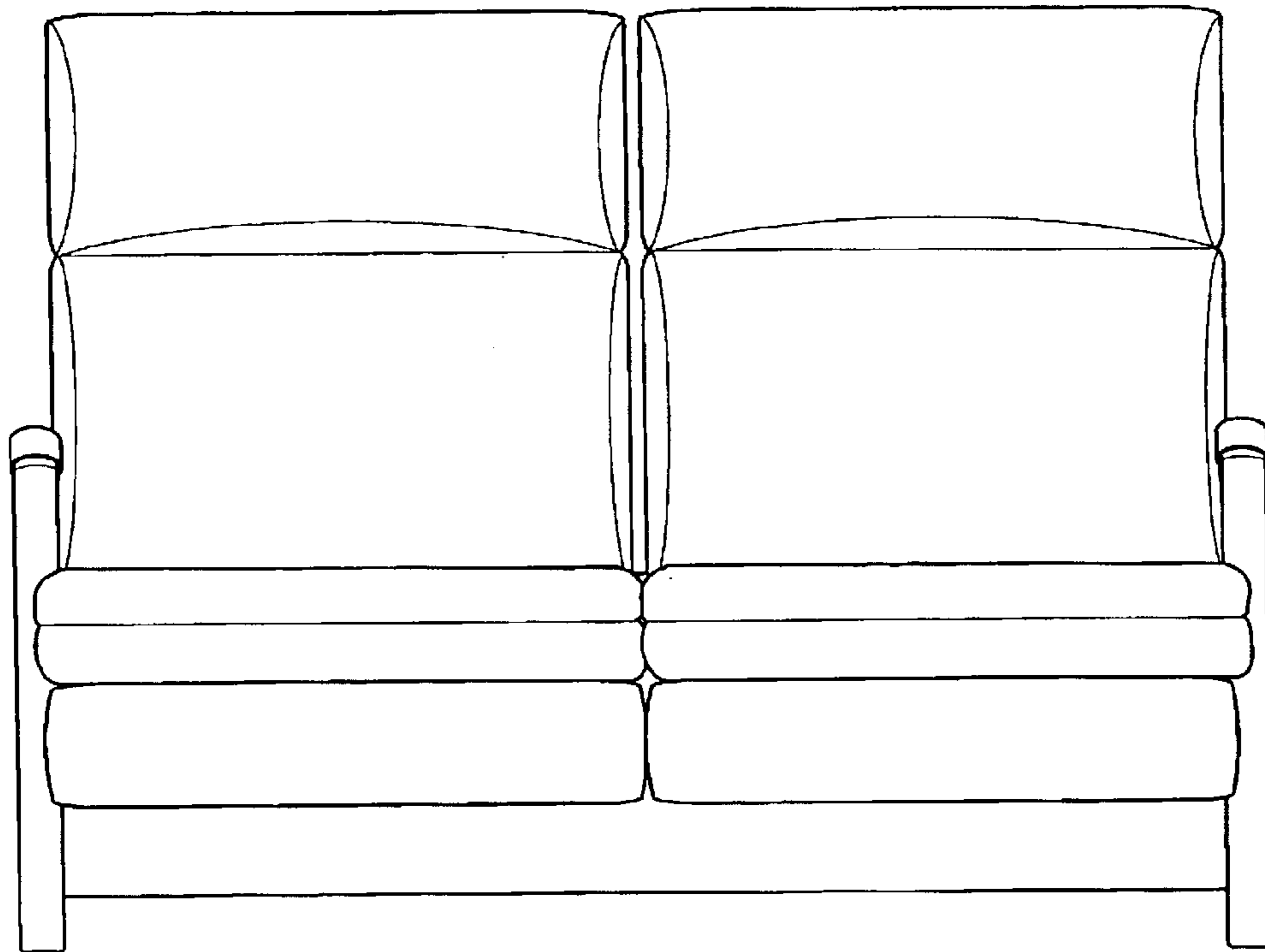
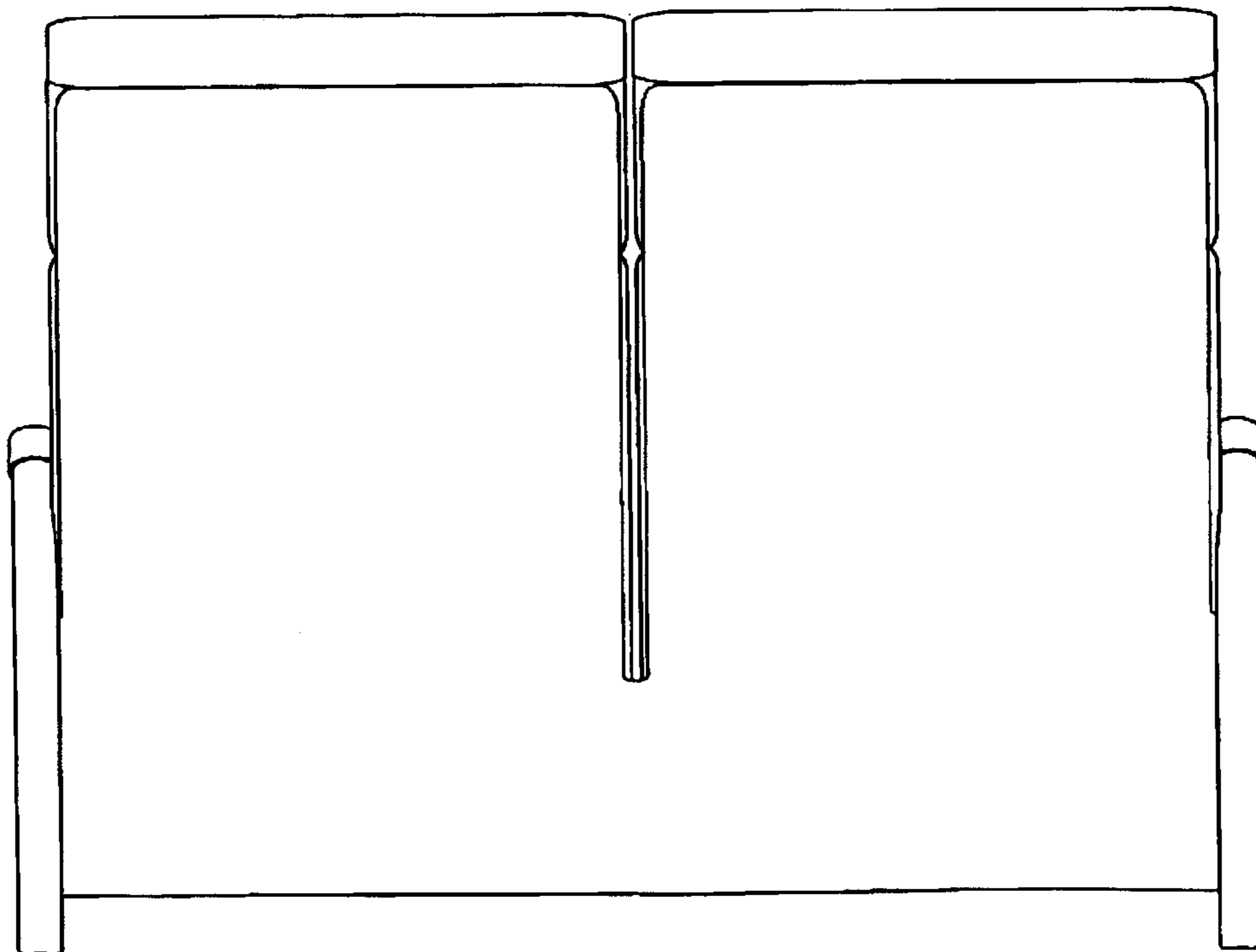


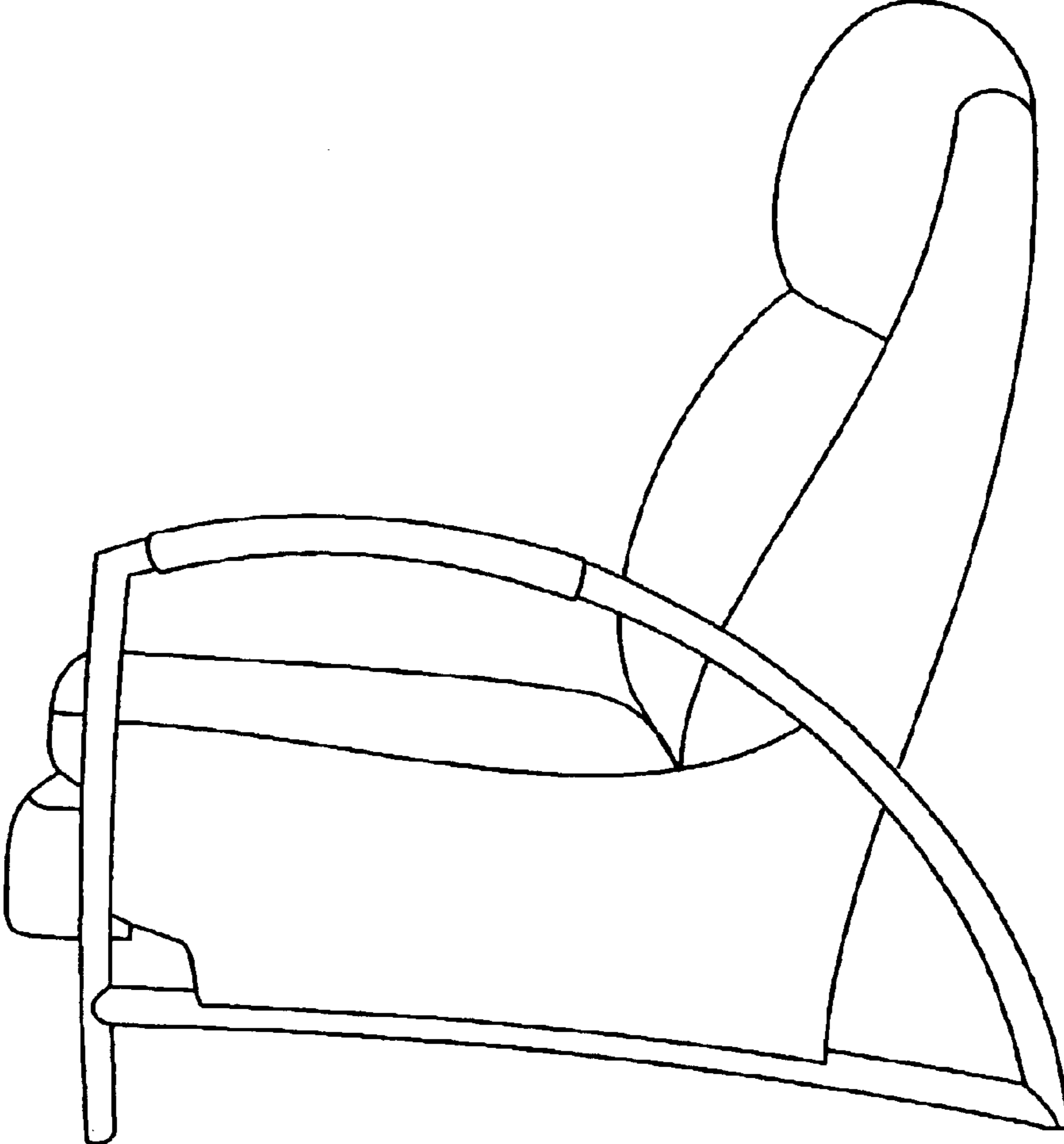
FIGURE 5



**FIGURE 6**



**FIGURE 7**



**FIGURE 8**

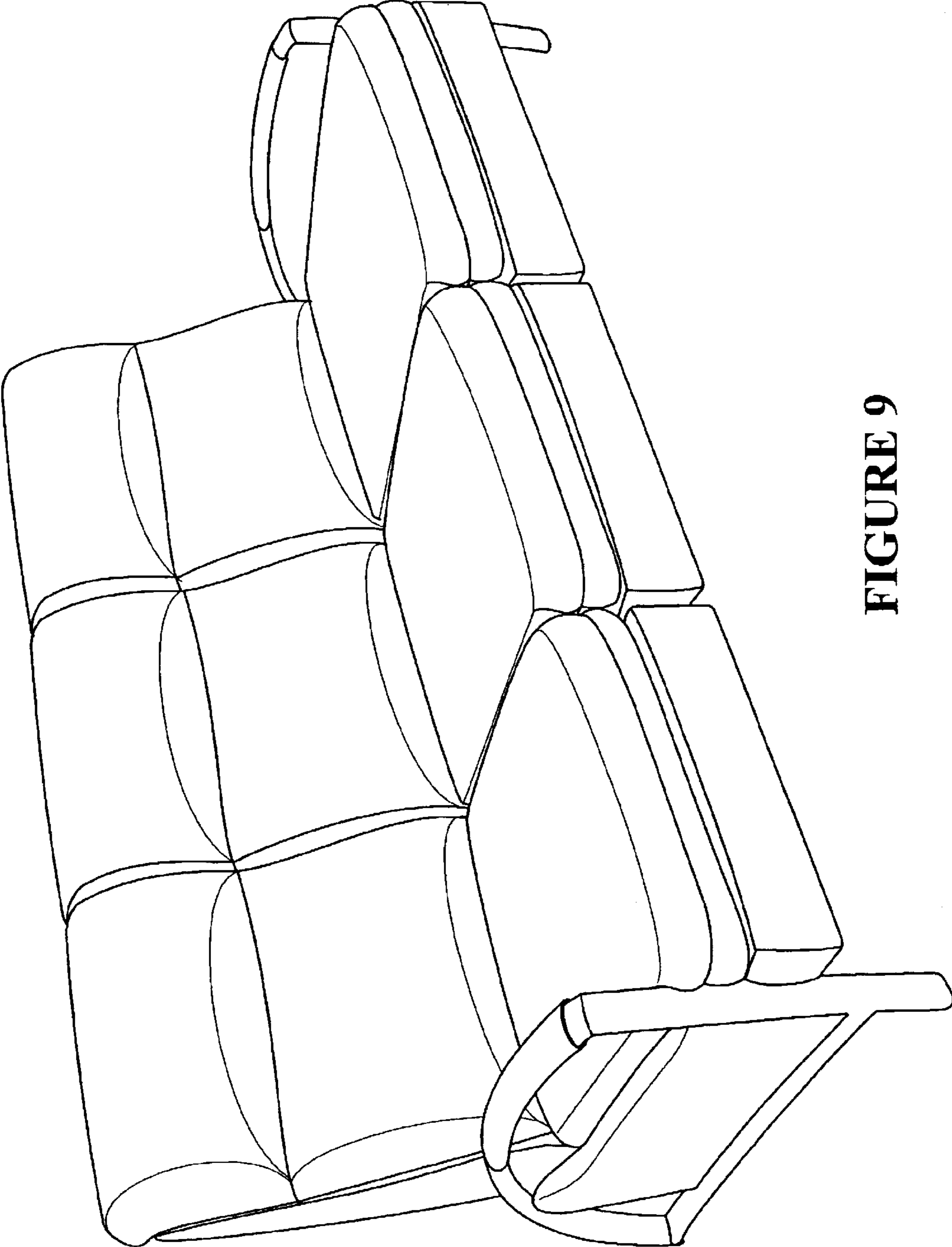


FIGURE 9



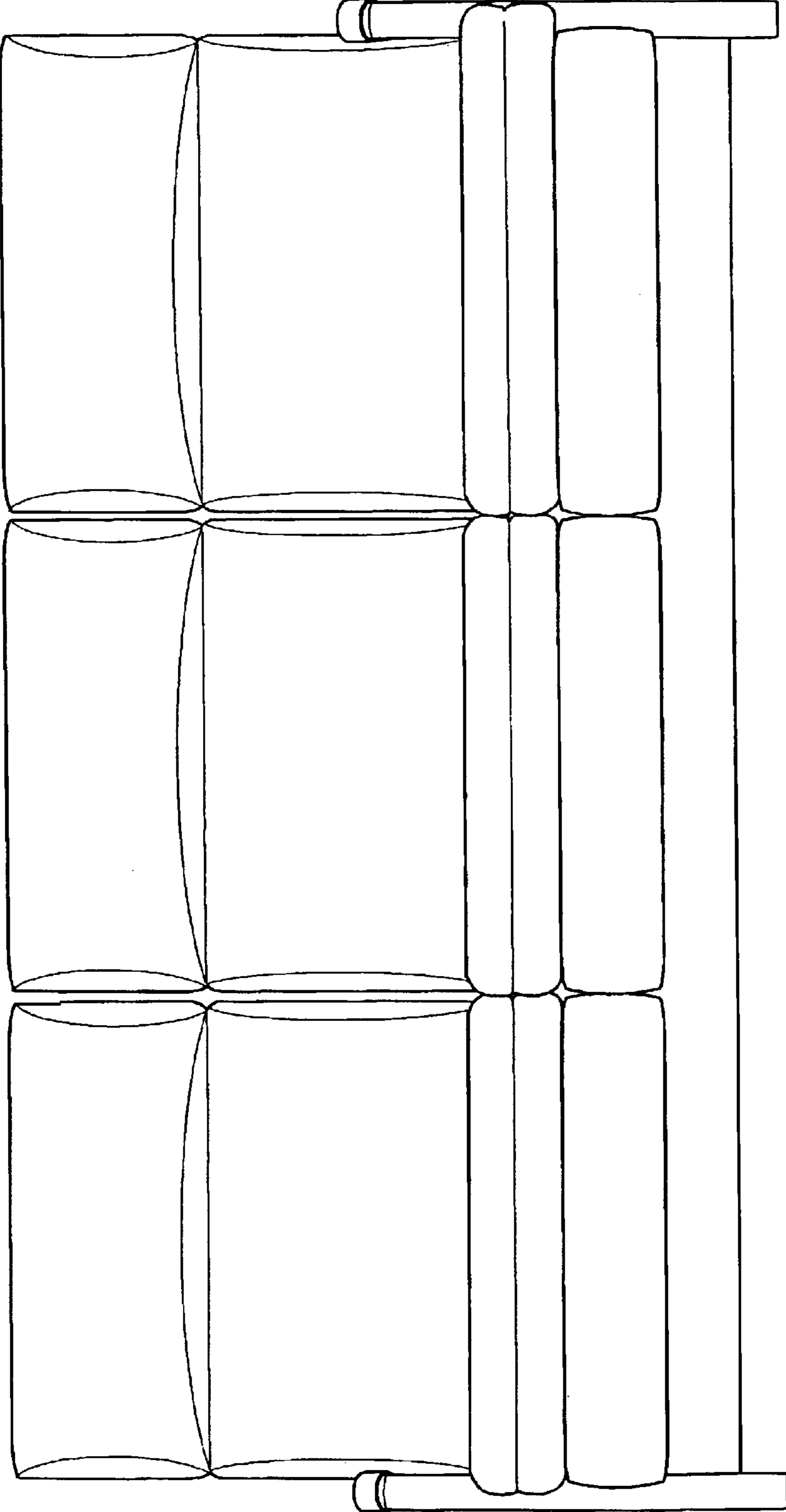


FIGURE 10

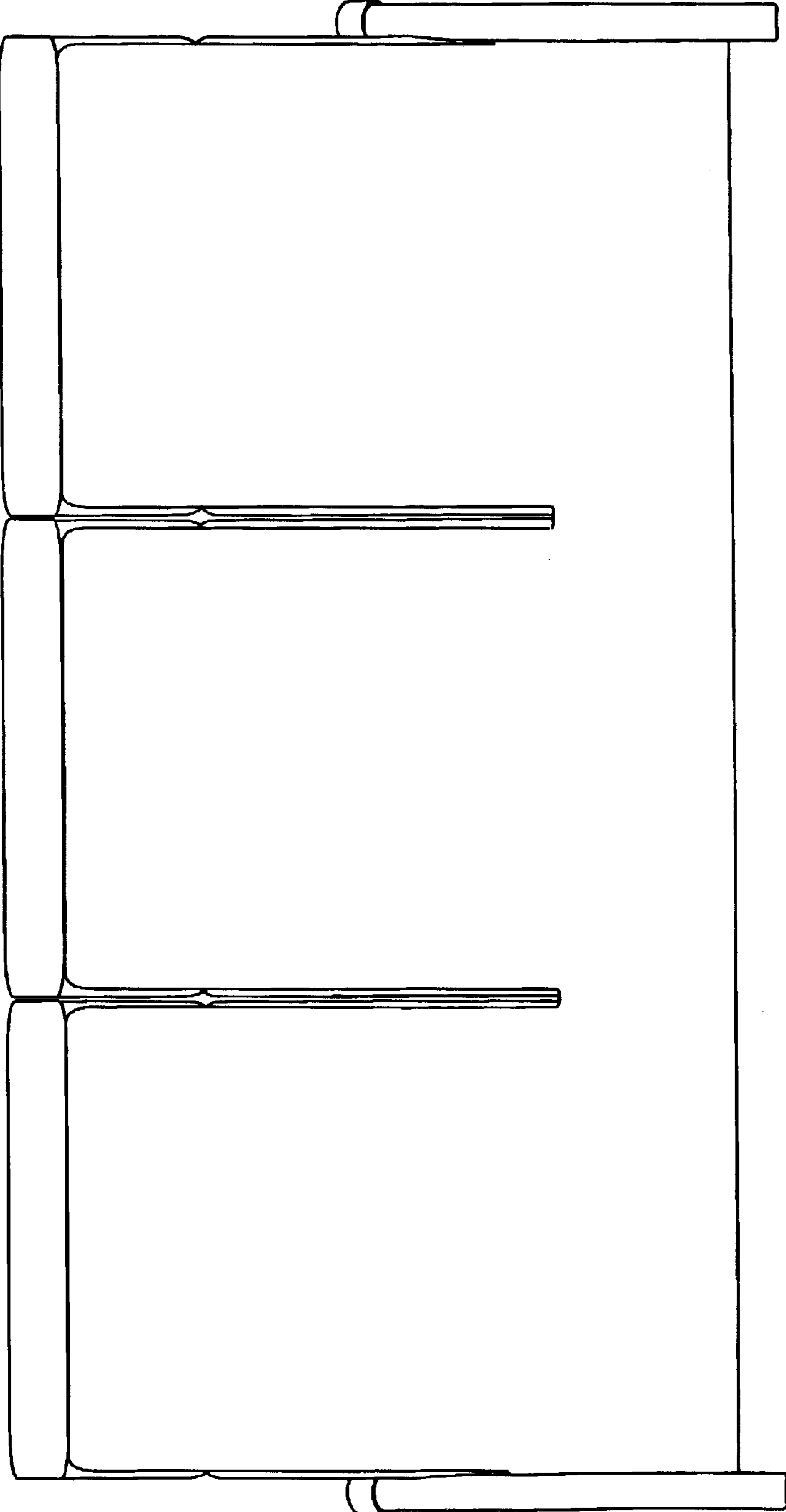
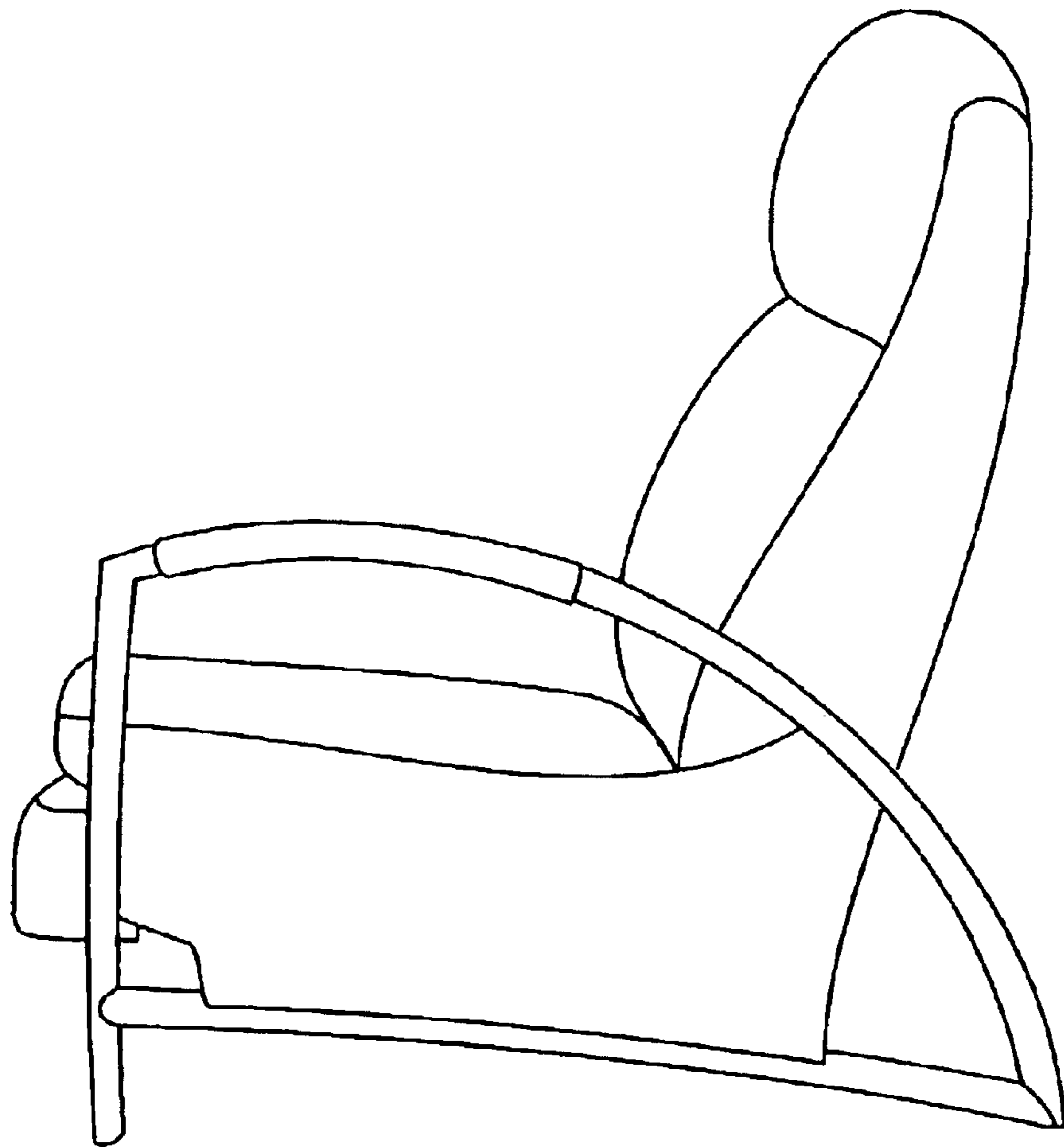
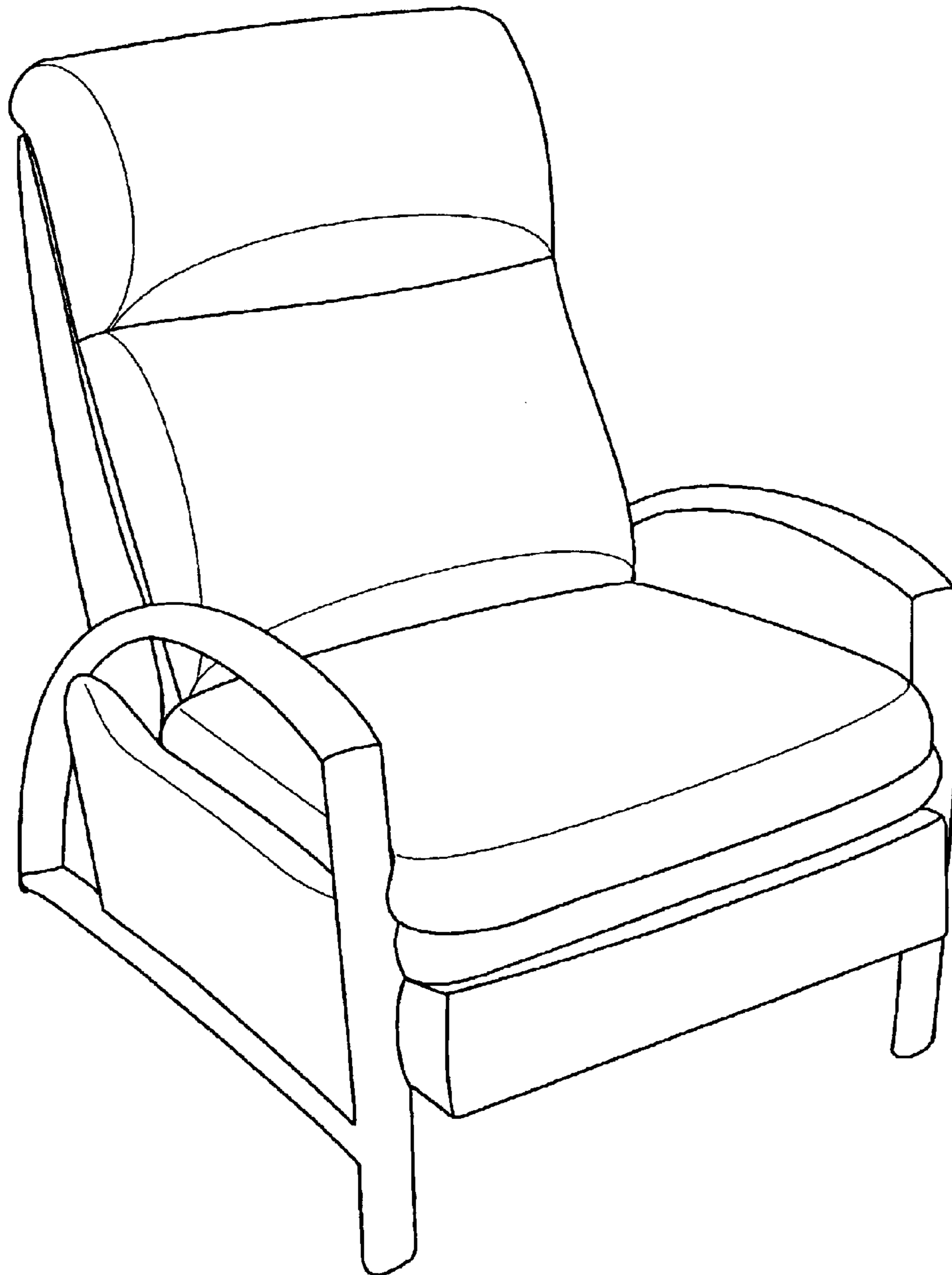


FIGURE 11

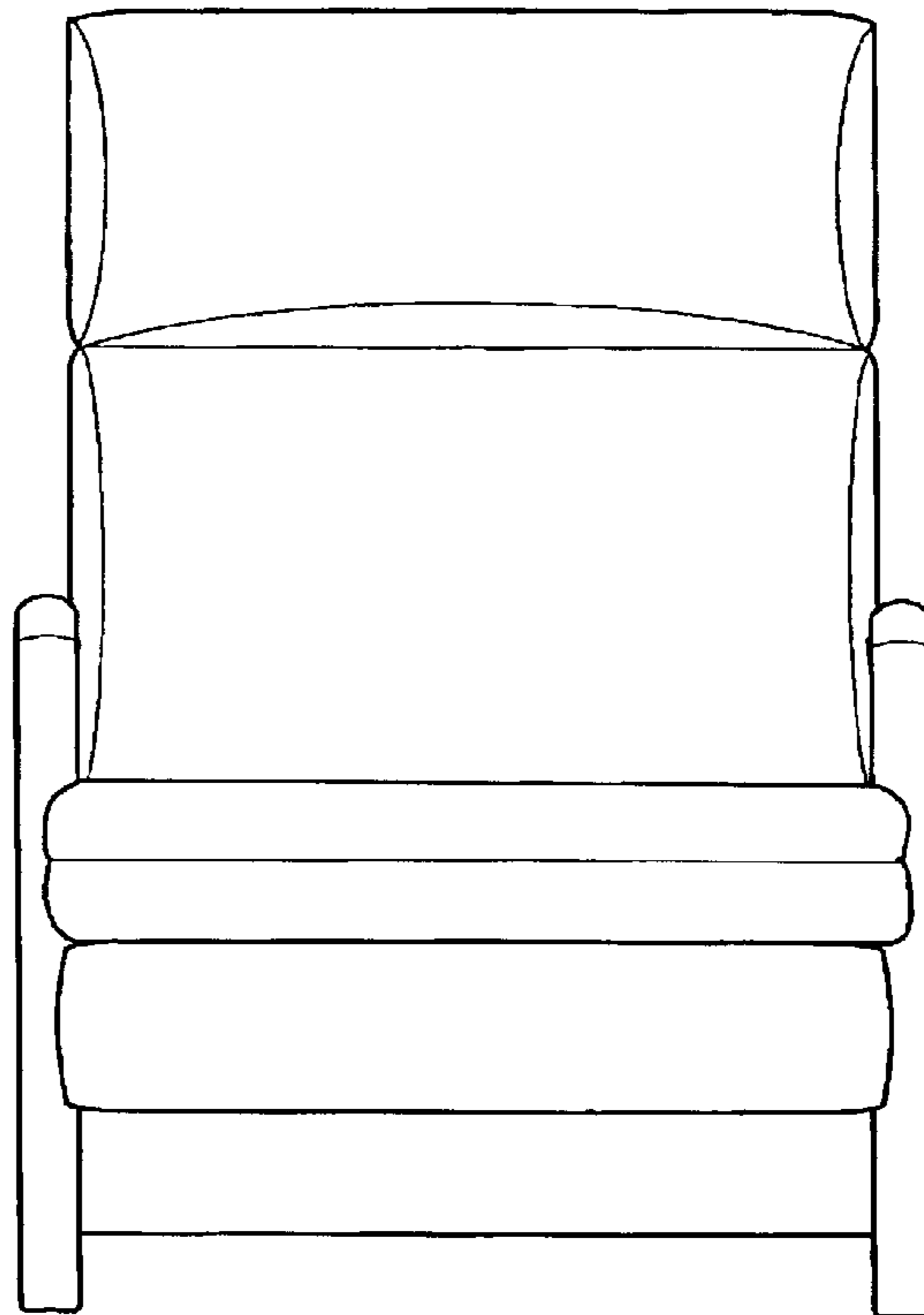


**FIGURE 12**

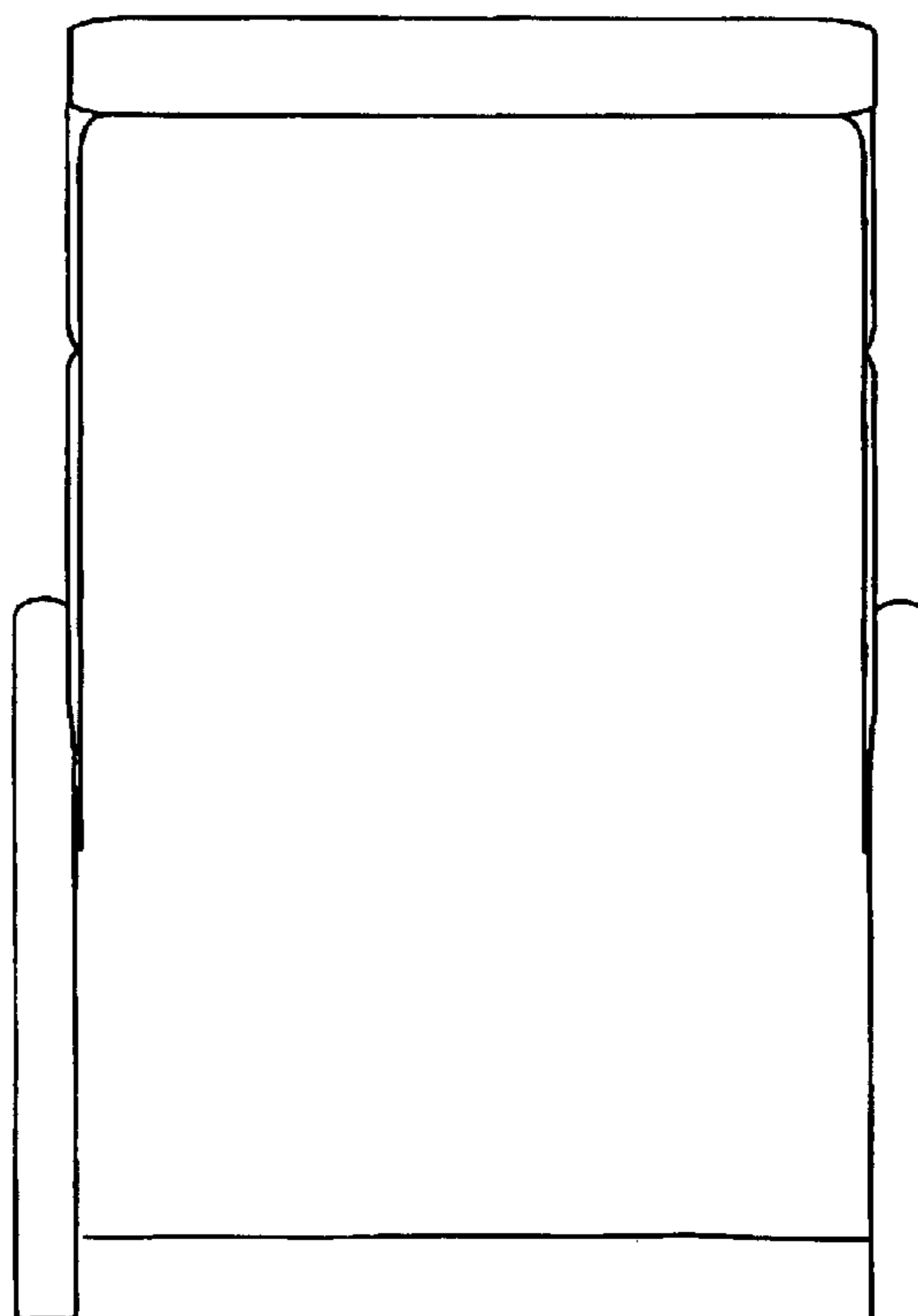


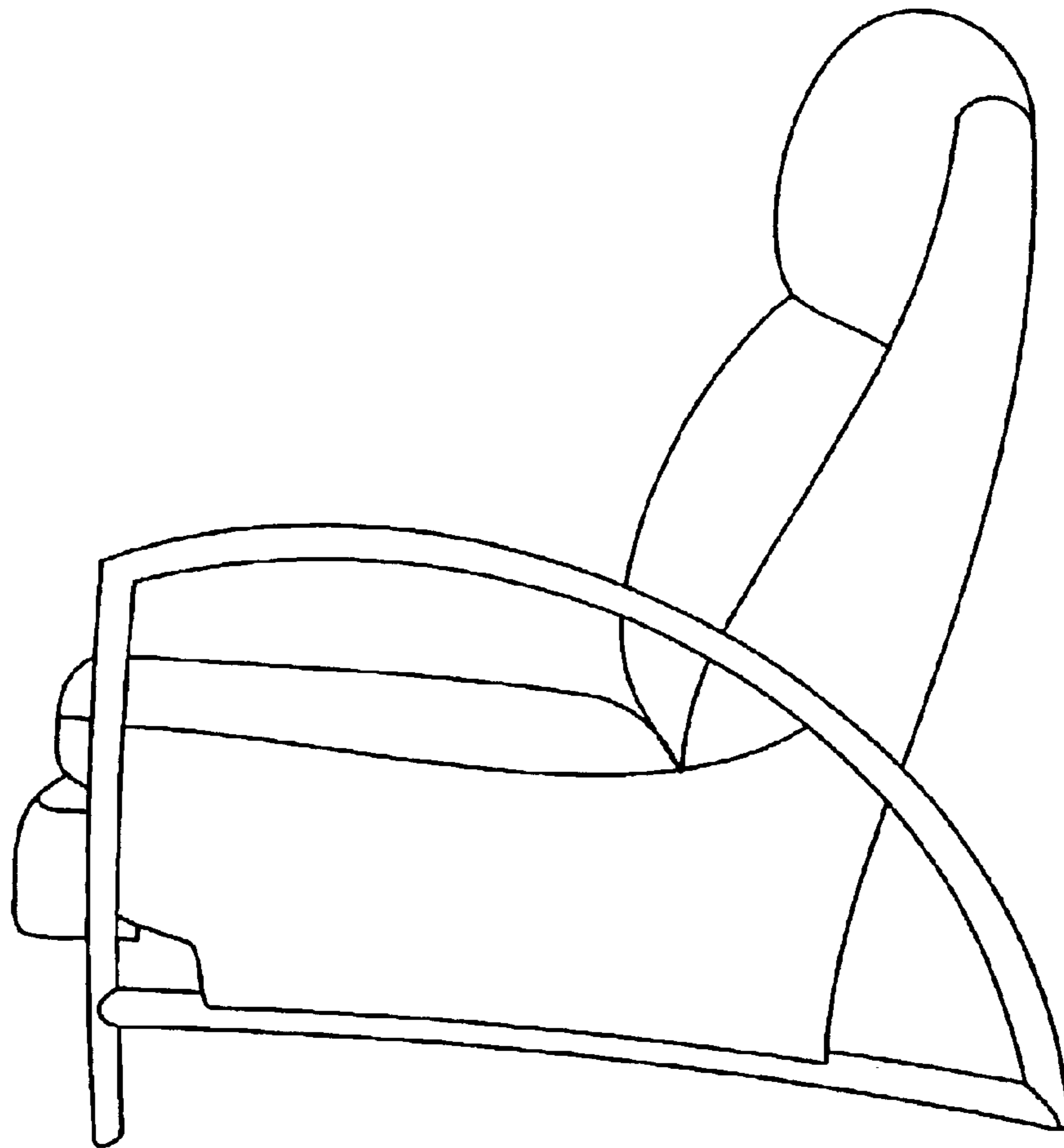
**FIGURE 13**

**FIGURE 14**



**FIGURE 15**





**FIGURE 16**

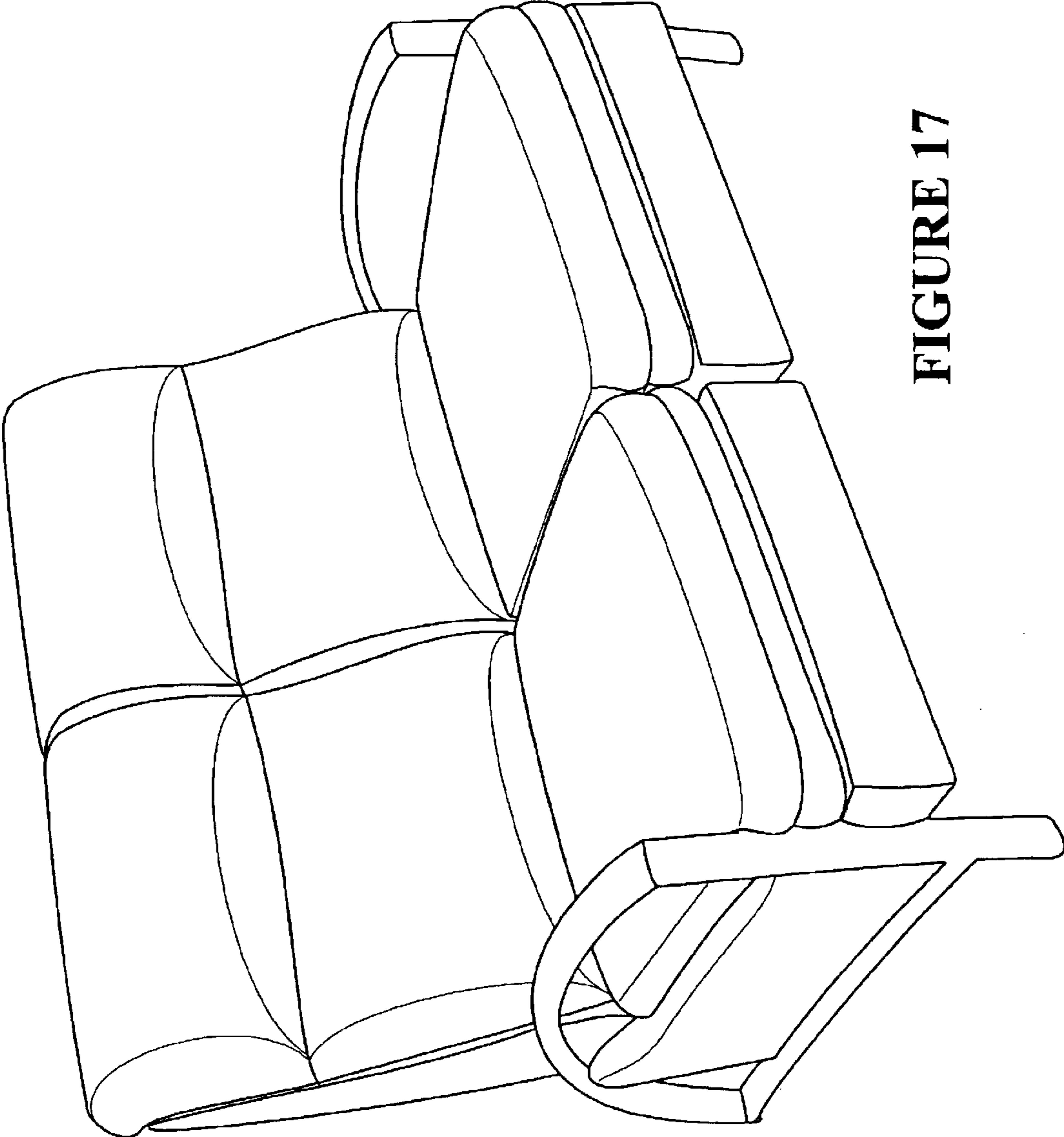
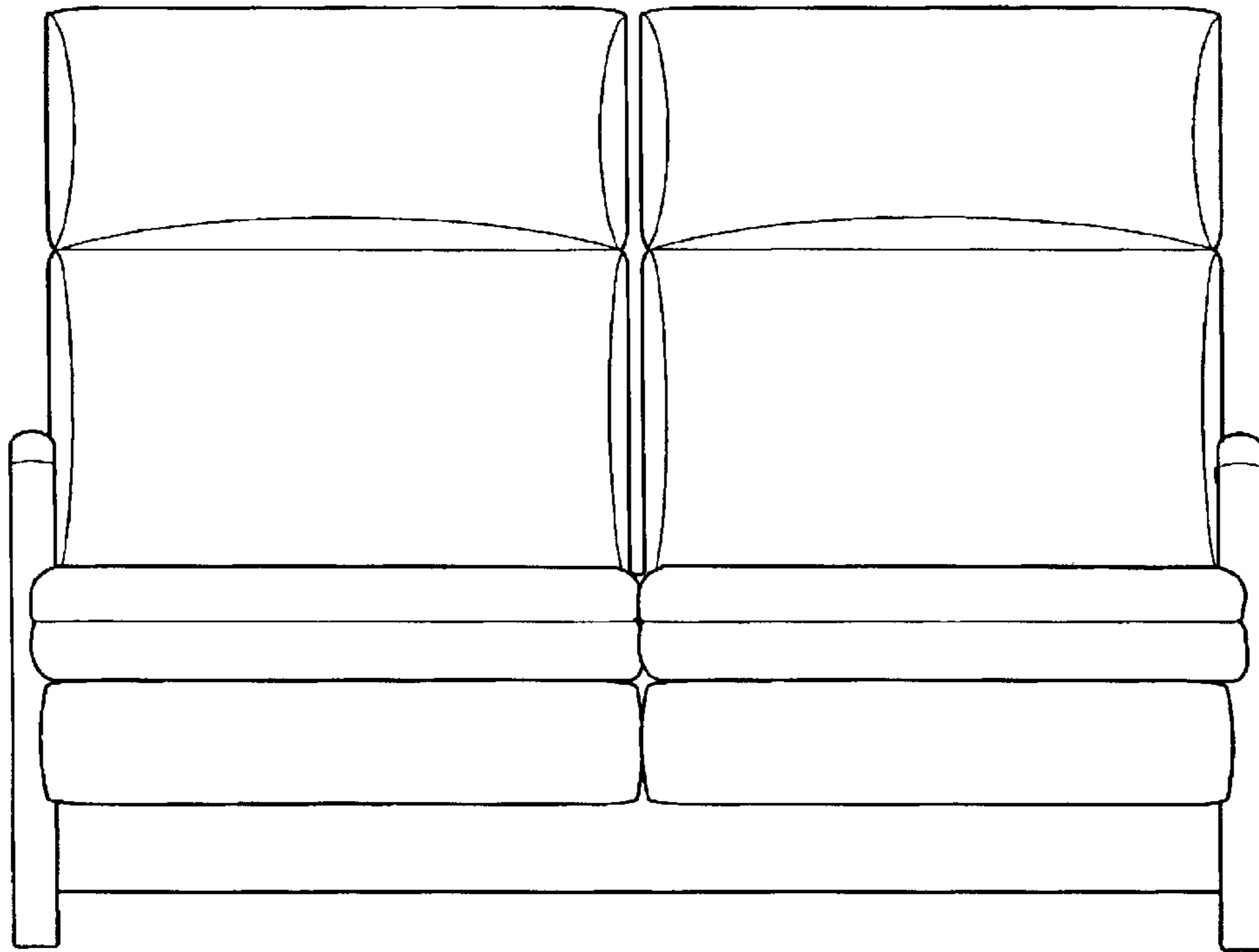
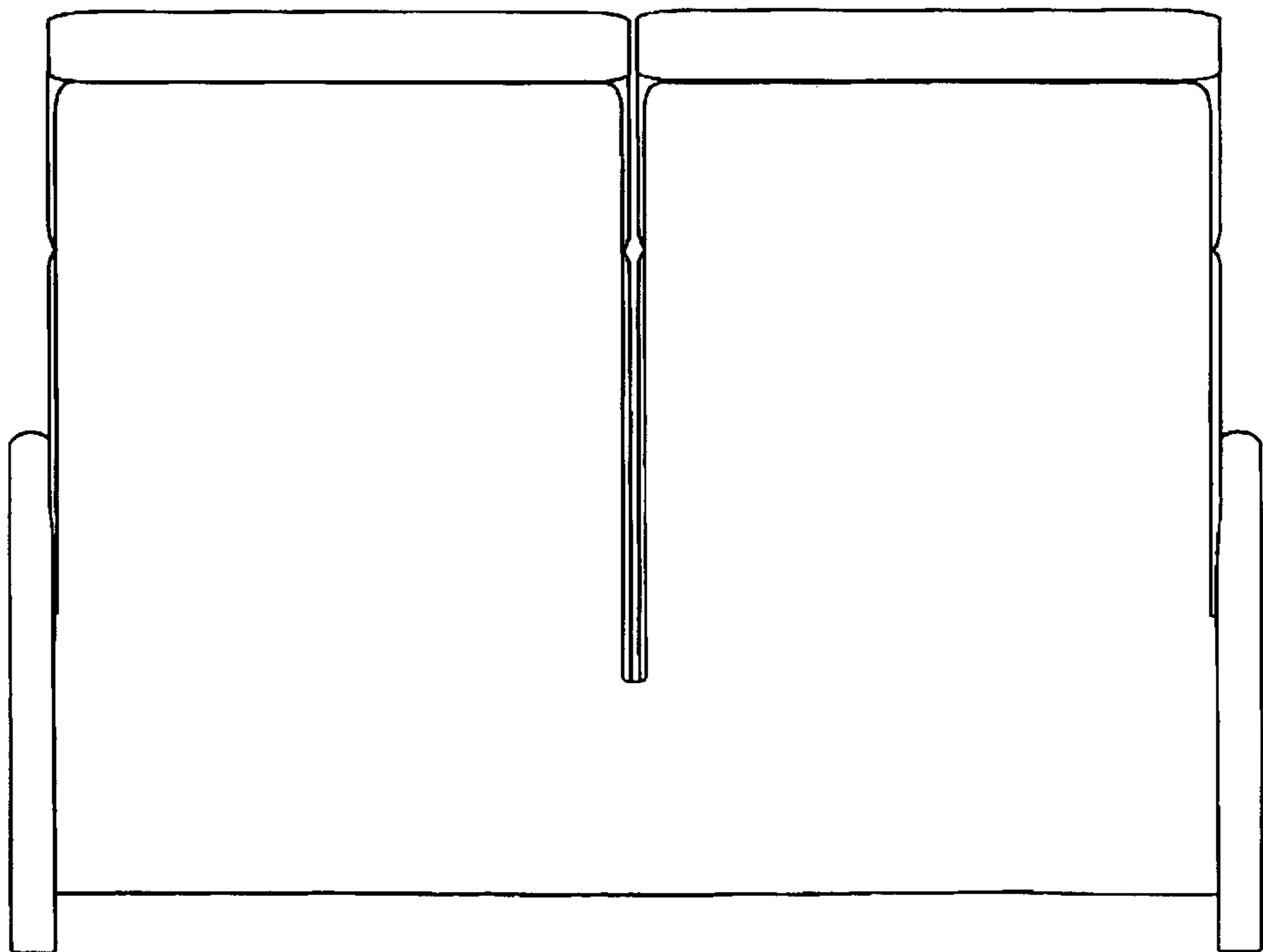


FIGURE 17

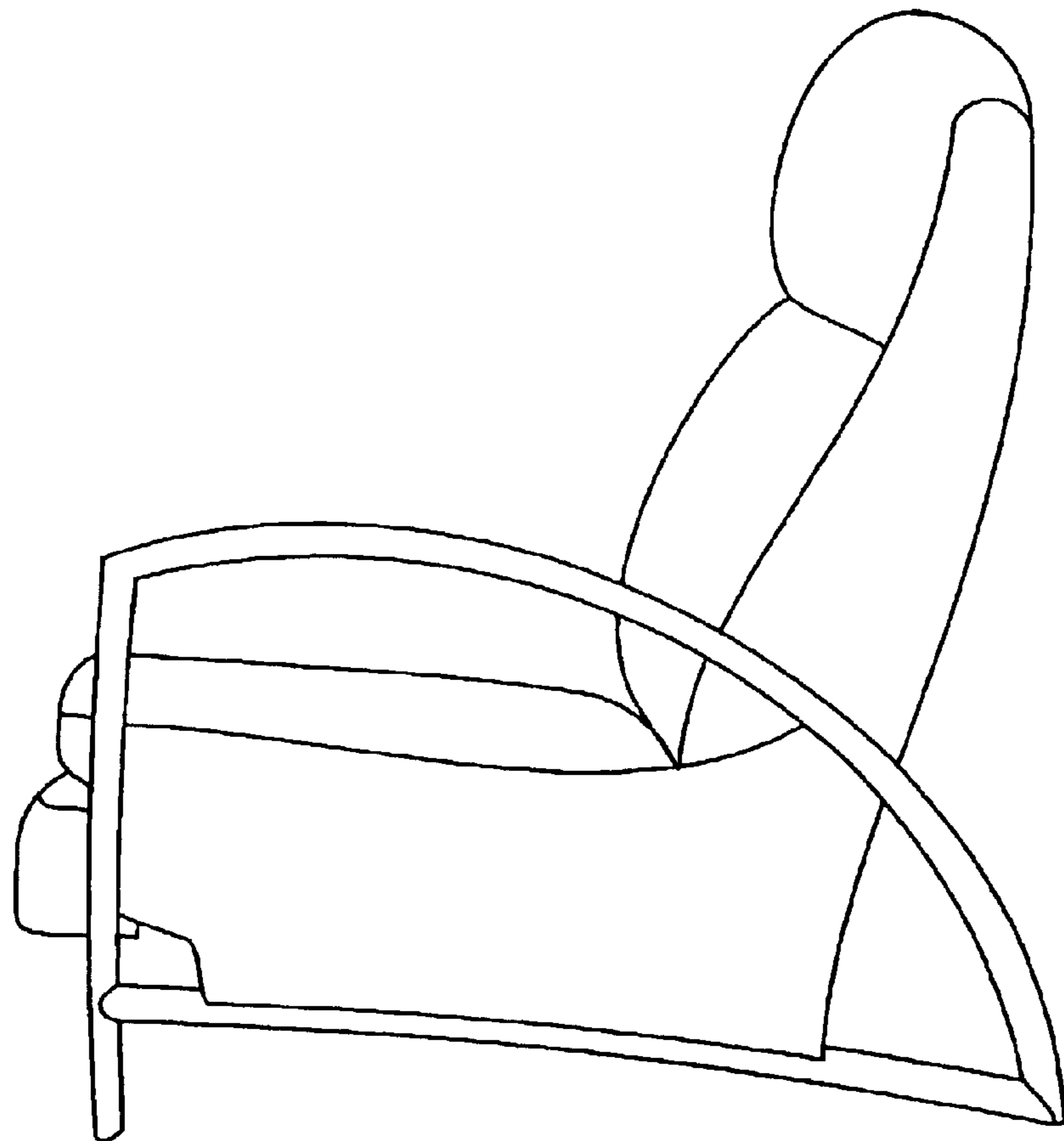


**FIGURE 18**



**FIGURE 19**





**FIGURE 20**

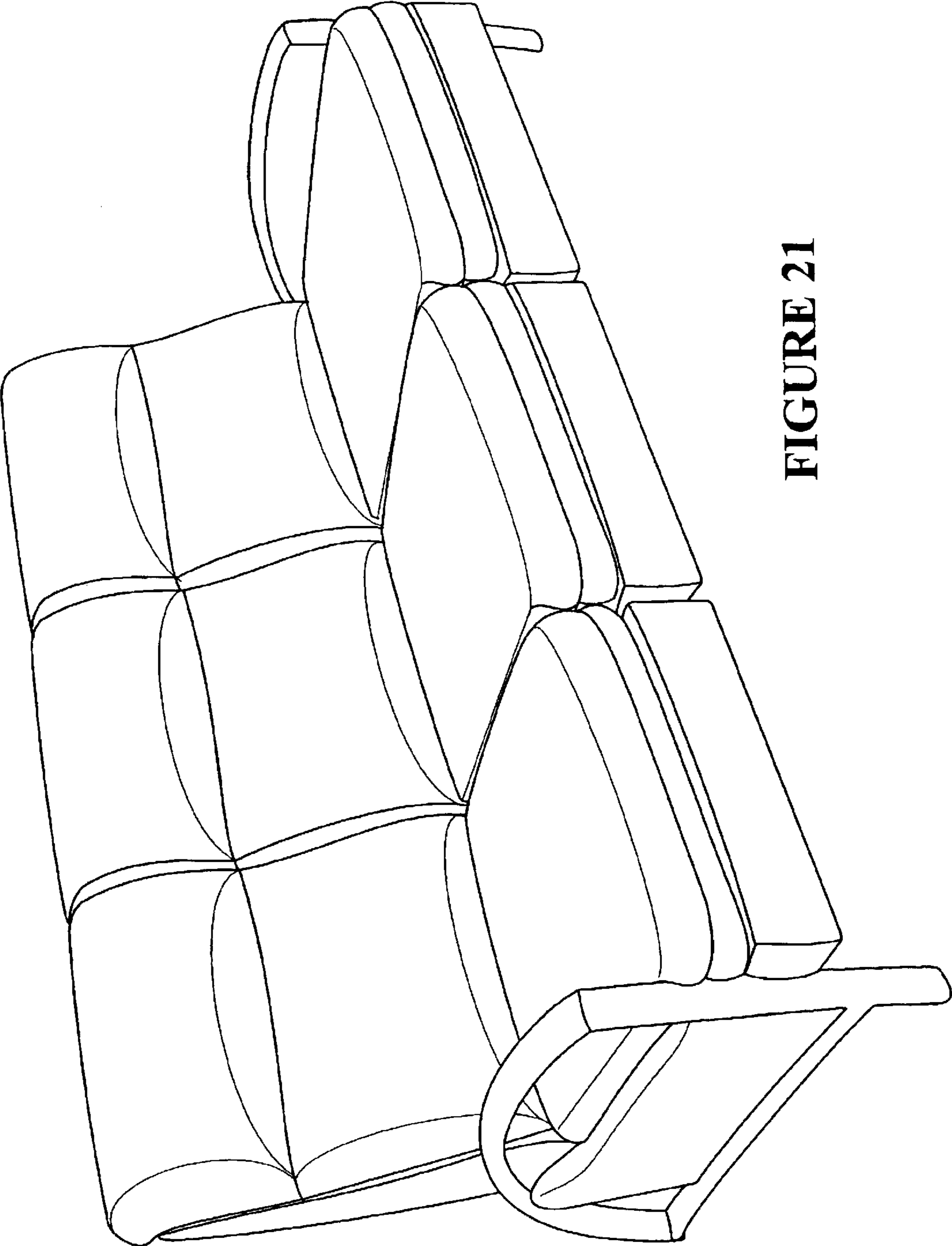


FIGURE 21

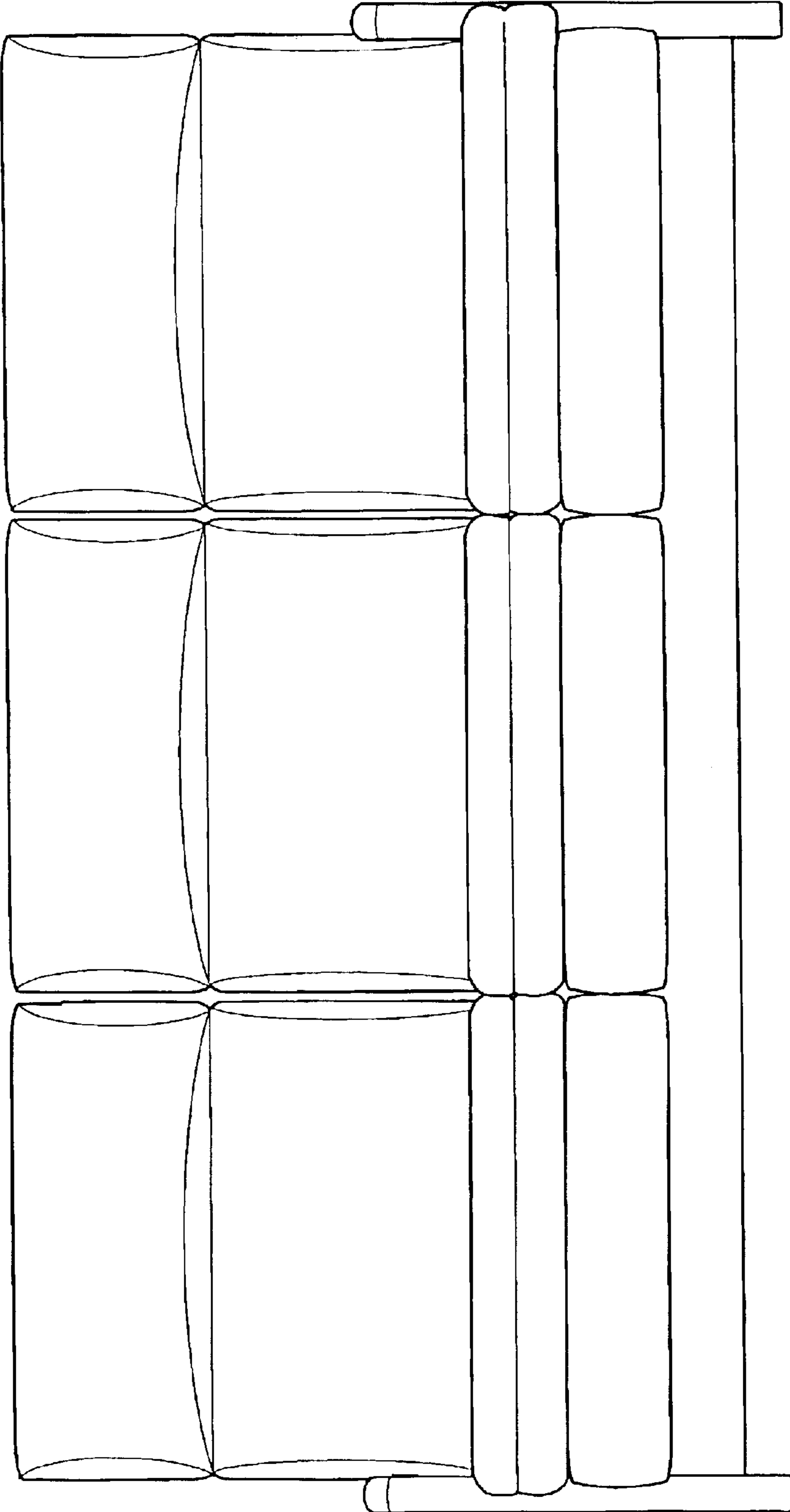


FIGURE 22

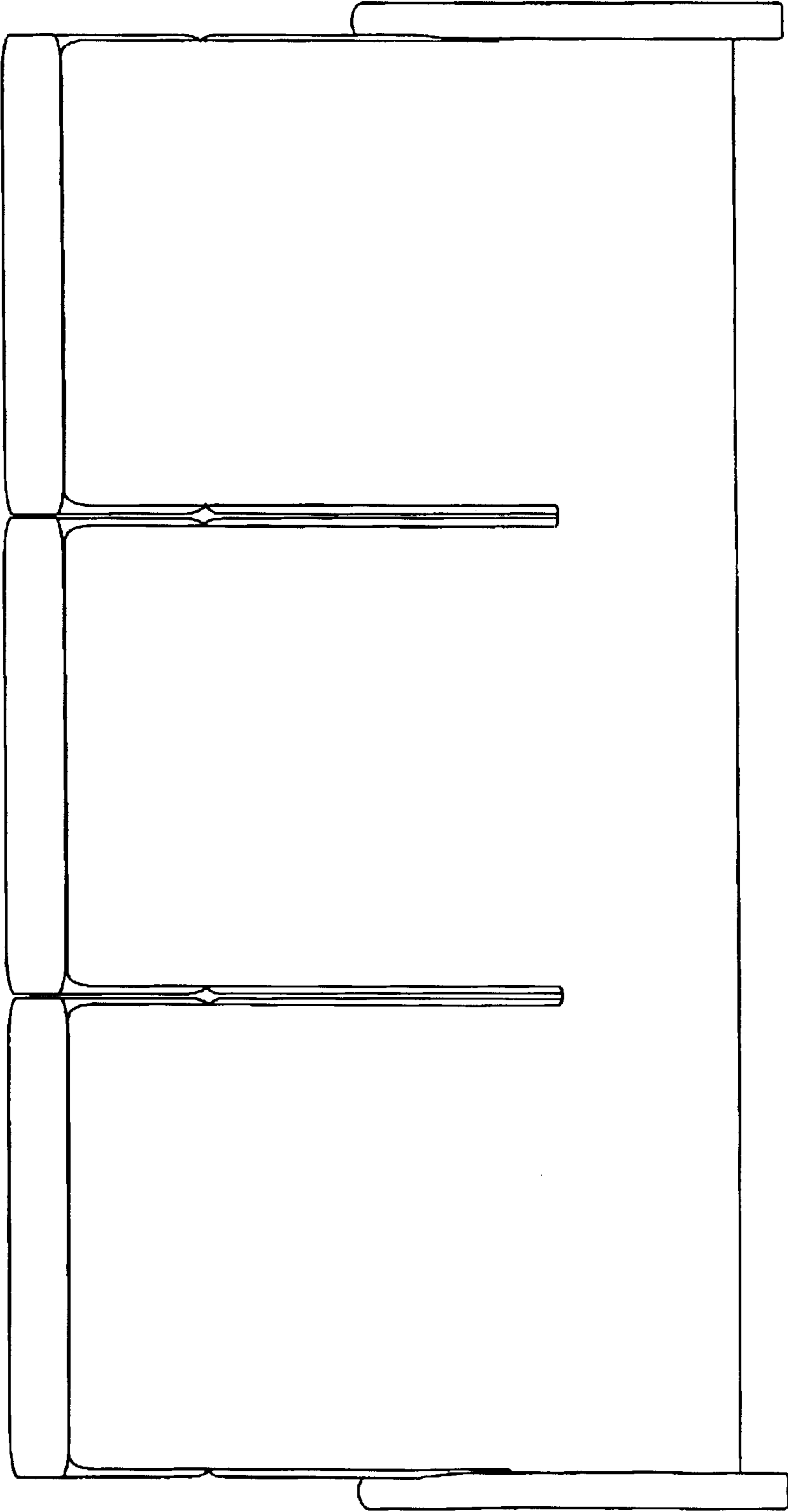
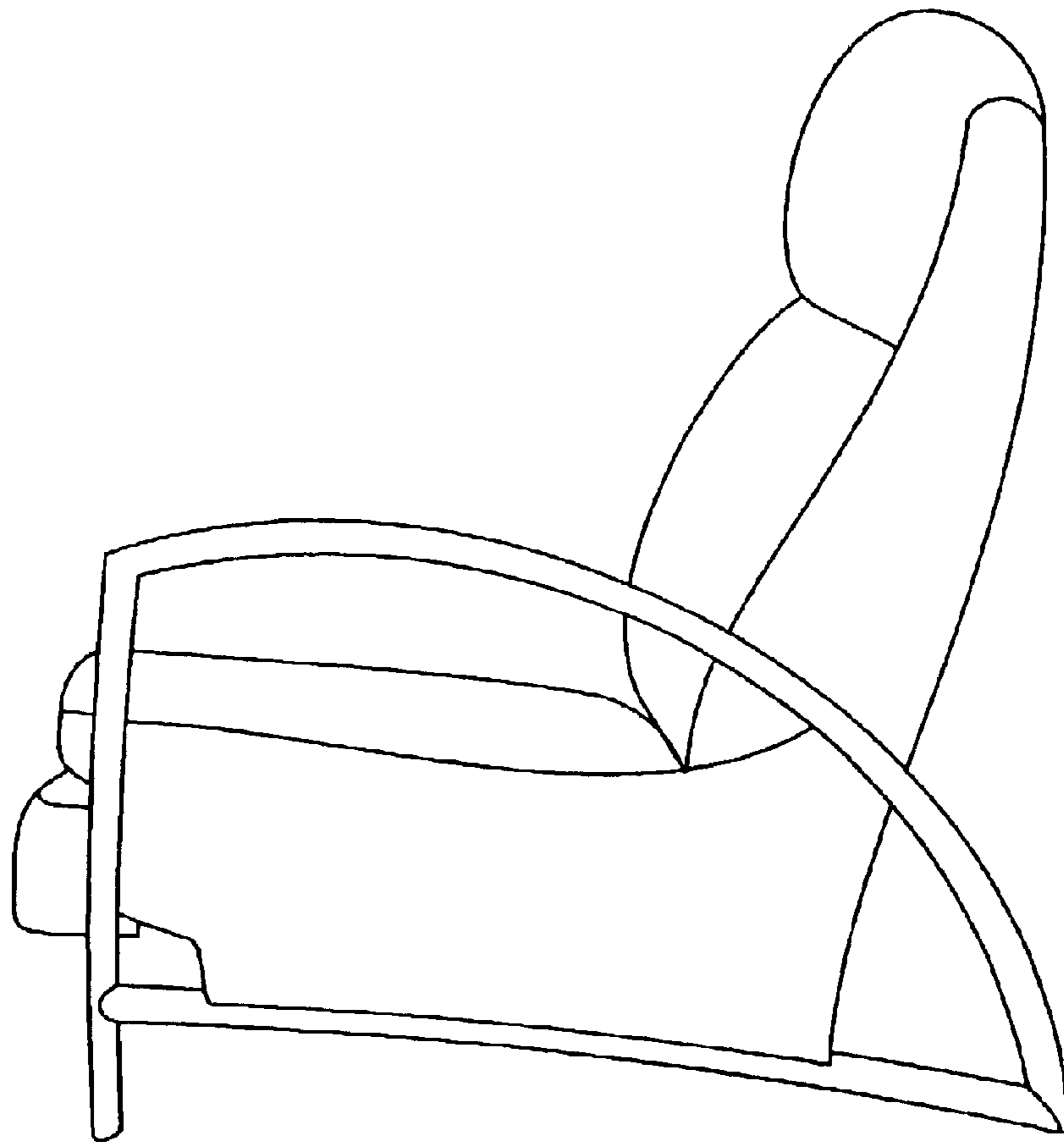


FIGURE 23



**FIGURE 24**