

US00D494168S1

(12) **United States Design Patent**  
**Hammond et al.**

(10) **Patent No.: US D494,168 S**

(45) **Date of Patent: \*\* Aug. 10, 2004**

(54) **RESTAURANT ORDER TERMINAL**

(76) Inventors: **Howard Kent Hammond**, 6912 Hanover Pkwy. #203, Greenbelt, MD (US) 20770; **Derek Jacobs**, 1320 Saxony Way, Florence, SC (US) 29506; **Bridget K. Hammond**, 6912 Hanover Pkwy. #203, Greenbelt, MD (US) 20774; **Angela Jacobs**, 1320 Saxony Way, Florence, SC (US) 29506

(\*\*) Term: **14 Years**

(21) Appl. No.: **29/189,163**

(22) Filed: **Aug. 29, 2003**

(51) **LOC (7) Cl. .... 14-02**

(52) **U.S. Cl. .... D14/346**

(58) **Field of Search** ..... D14/341, 343, D14/346; D18/1, 2, 7; 235/145 A, 145 R; 341/22, 23; 345/156, 168, 169, 172, 173; 361/680-686; 349/12; D6/449; 709/200

(56) **References Cited**

U.S. PATENT DOCUMENTS

D307,890 S \* 5/1990 Kim ..... D14/346

D333,743 S \* 3/1993 Johnson ..... D6/449  
D369,144 S \* 4/1996 Carlos et al. .... D14/343  
5,964,830 A \* 10/1999 Durrett ..... 709/200  
D451,096 S \* 11/2001 Redmond ..... D14/343  
D461,803 S \* 8/2002 Griffin et al. .... D14/346  
D464,963 S \* 10/2002 Nishida ..... D14/346  
D468,342 S \* 1/2003 Bodum ..... D18/7  
D478,584 S \* 8/2003 Barthell ..... D14/346

\* cited by examiner

*Primary Examiner*—Freda S. Nunn

(57) **CLAIM**

The ornamental design for a restaurant order terminal, as shown and described.

**DESCRIPTION**

FIG. 1 is a perspective view of a restaurant order terminal showing our new design;  
FIG. 2 is a front elevational view thereof;  
FIG. 3 is a top plan view thereof  
FIG. 4 is a rear elevational view thereof;  
FIG. 5 is a bottom plan view thereof;  
FIG. 6 is a side view, taken from the left side of FIG. 2; and,  
FIG. 7 is a side view, taken from the right side of FIG. 1.

**1 Claim, 4 Drawing Sheets**

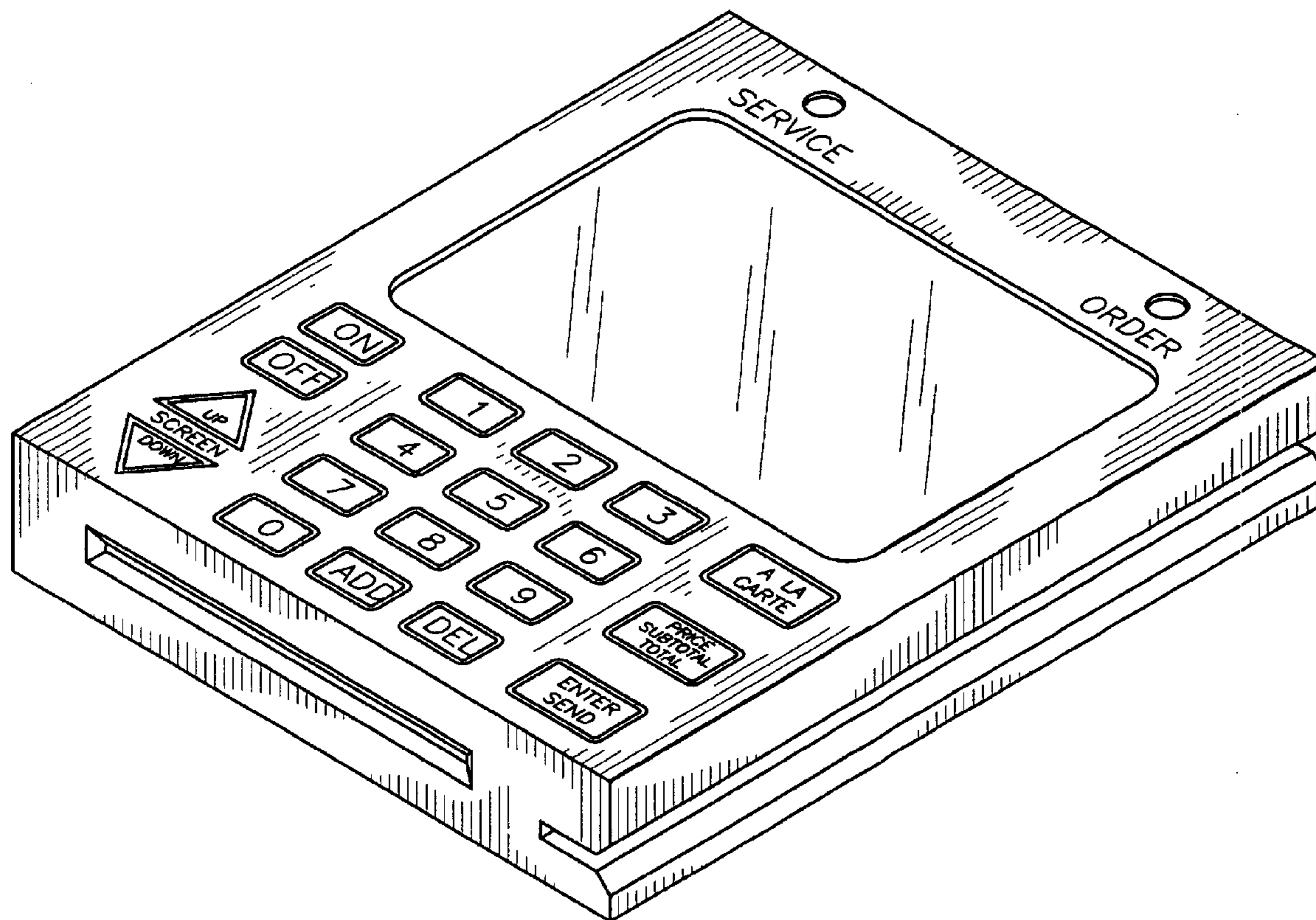

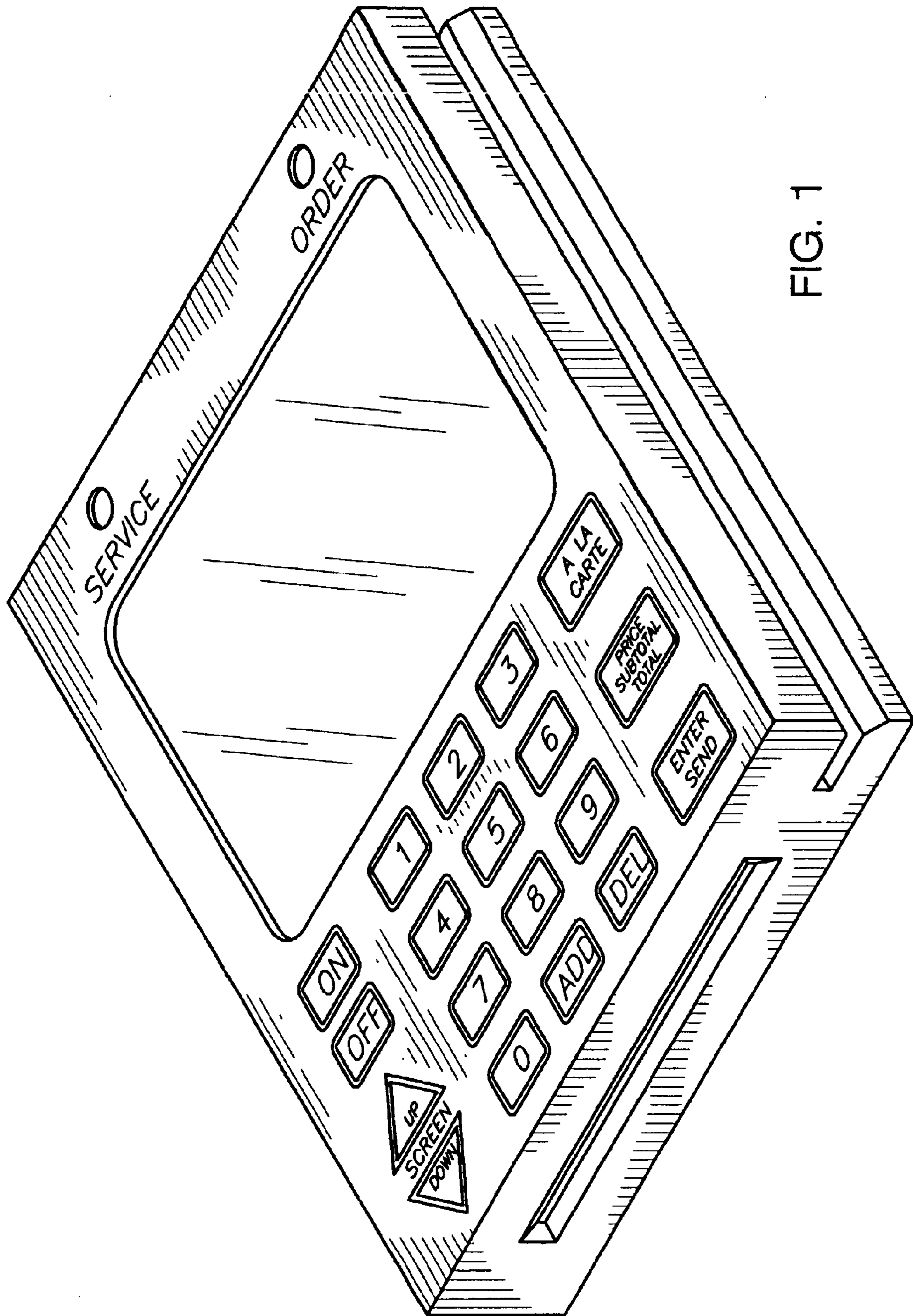

FIG. 1

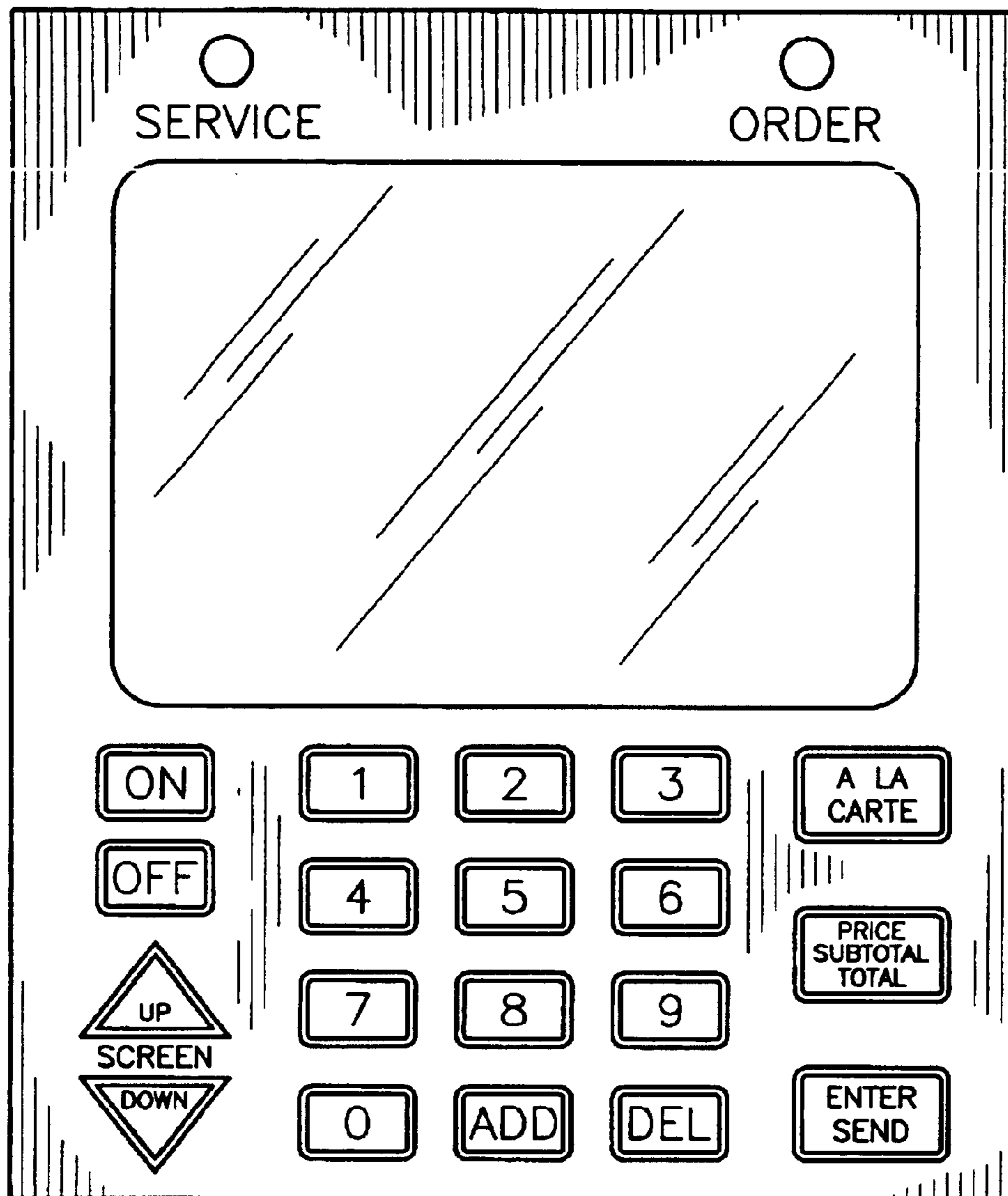

FIG. 2

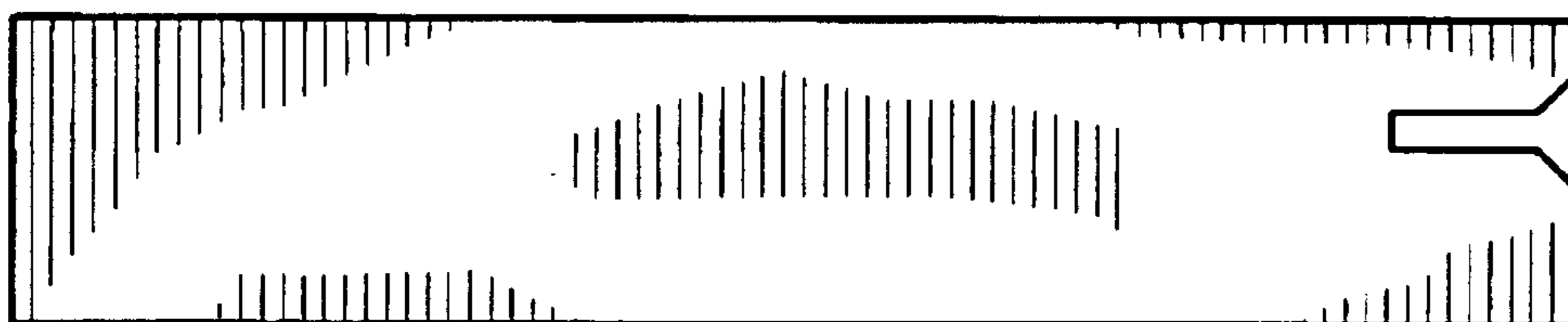

FIG. 3



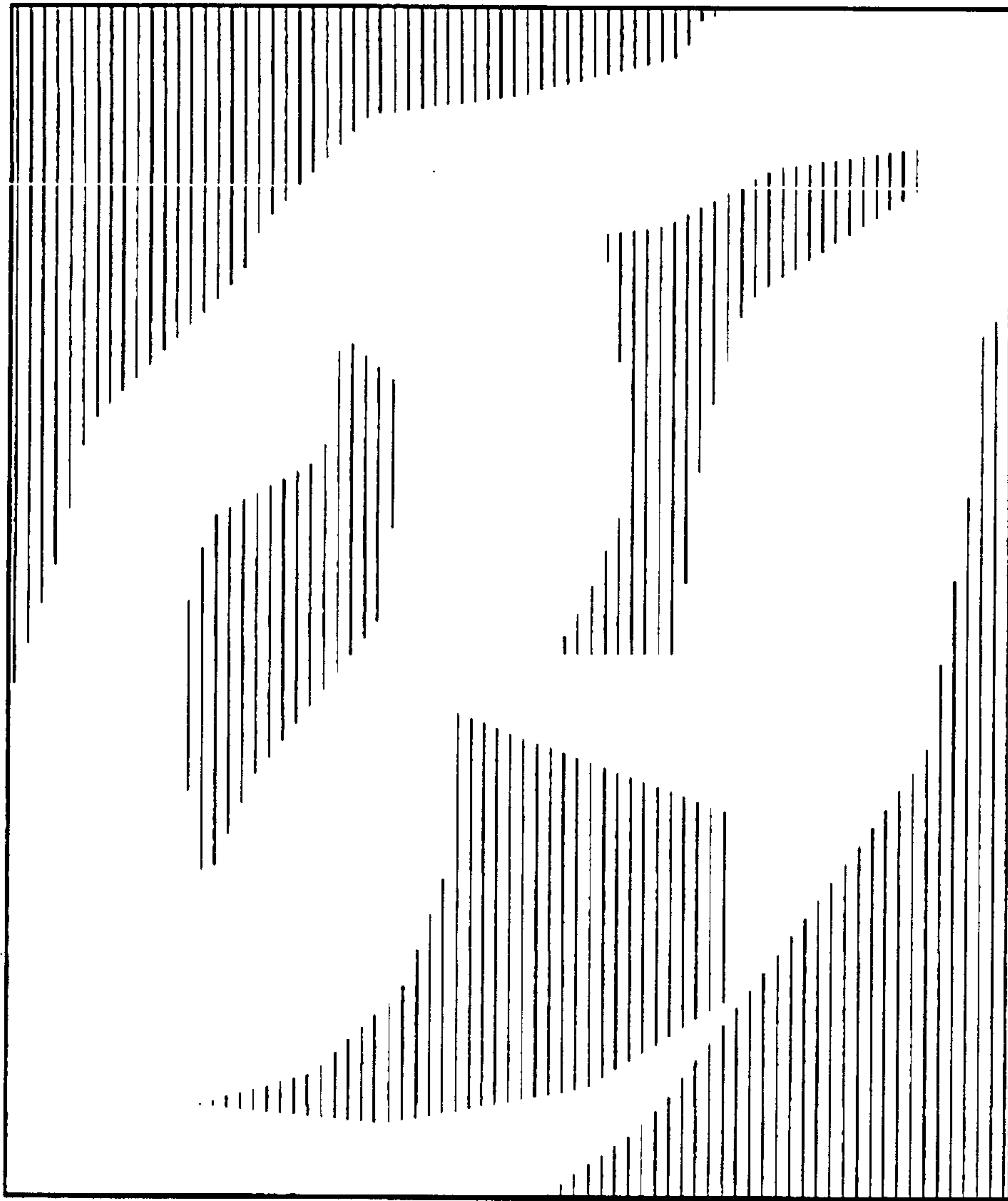

FIG. 4

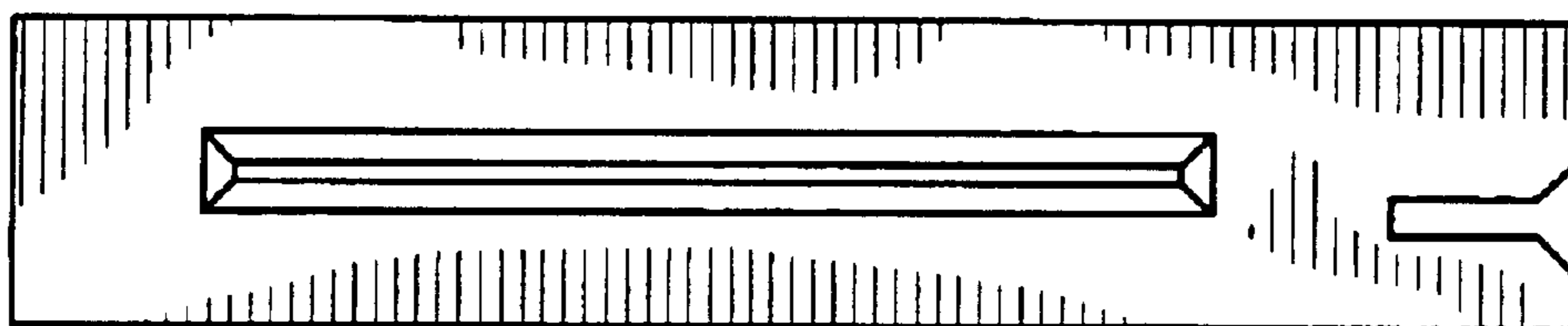

FIG. 5

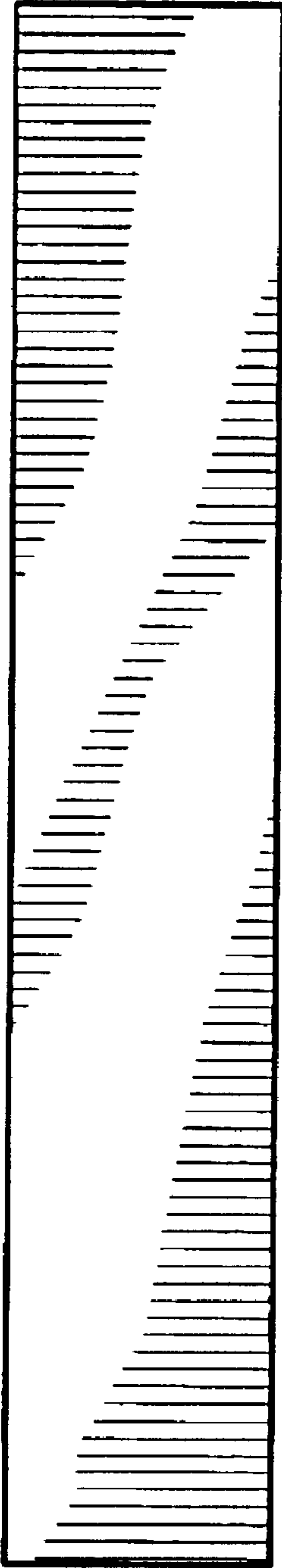

FIG. 6

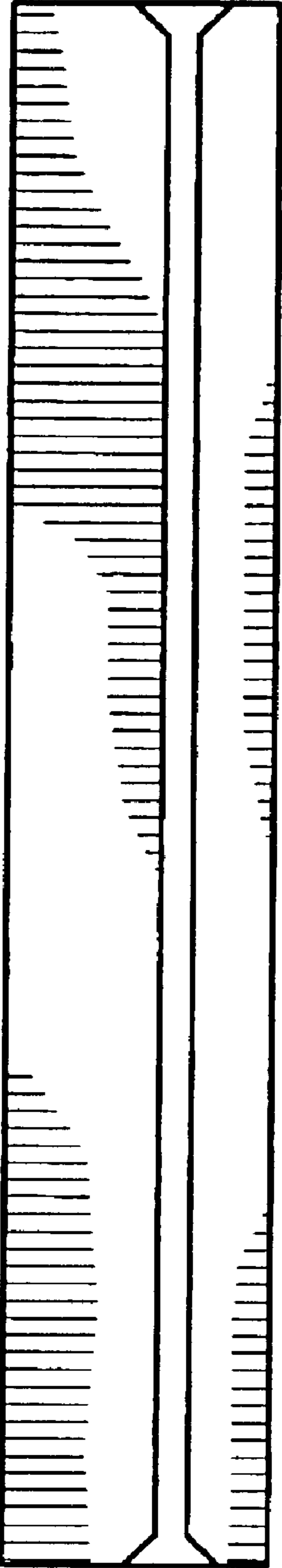

FIG. 7