

US00D494109S1

(12) **United States Design Patent**
Karasin et al.

(10) **Patent No.:** **US D494,109 S**
(45) **Date of Patent:** **** Aug. 10, 2004**

(54) **WALKER**

(75) Inventors: **Craig E. Karasin**, 805 Albury Ct.,
Moorestown, NJ (US) 08057; **Thomas**
J. Powers, Fairless Hills, PA (US);
David G. Reed, Langhorne, PA (US)

(73) Assignee: **Craig E. Karasin**, Moorestown, NJ
(US)

(**) Term: **14 Years**

(21) Appl. No.: **29/188,934**

(22) Filed: **Aug. 25, 2003**

(51) **LOC (7) Cl.** **12-12**

(52) **U.S. Cl.** **D12/130**

(58) **Field of Search** D12/128-133;
135/67, 68, 69, 72, 73, 84; 297/6

(56) **References Cited**

U.S. PATENT DOCUMENTS

D404,345 S	*	1/1999	Donets	D12/130
D420,624 S	*	2/2000	Gonzalez	D12/130
D474,133 S	*	5/2003	Cerelli	D12/130

* cited by examiner

Primary Examiner—Marcus A. Jackson
(74) *Attorney, Agent, or Firm*—Synnestvedt & Lechner
LLP

(57) **CLAIM**

The ornamental design for a walker, as shown and described.

DESCRIPTION

FIG. 1 is a front perspective view of the ornamental design of the walker of the present invention.
 FIG. 2 is a front view of the walker as shown in FIG. 1.
 FIG. 3 is a rear view of the walker as shown in FIG. 1.
 FIG. 4 is a side view of the walker as shown in FIG. 1.
 FIG. 5 is a top view of the walker as shown in FIG. 1.
 FIG. 6 is a bottom view of the walker as shown in FIG. 1.
 FIG. 7 is a rear perspective view of the walker as shown in FIG. 1.
 FIG. 8 is a front view of the front section of the walker as shown in FIG. 1.
 FIG. 9 is a side view of the front section of the walker as shown in FIG. 1.
 FIG. 10 is a back view of the front section of the walker as shown in FIG. 1; and,
 FIG. 11 is a front perspective view of the walker as shown in FIG. 1.

1 Claim, 11 Drawing Sheets

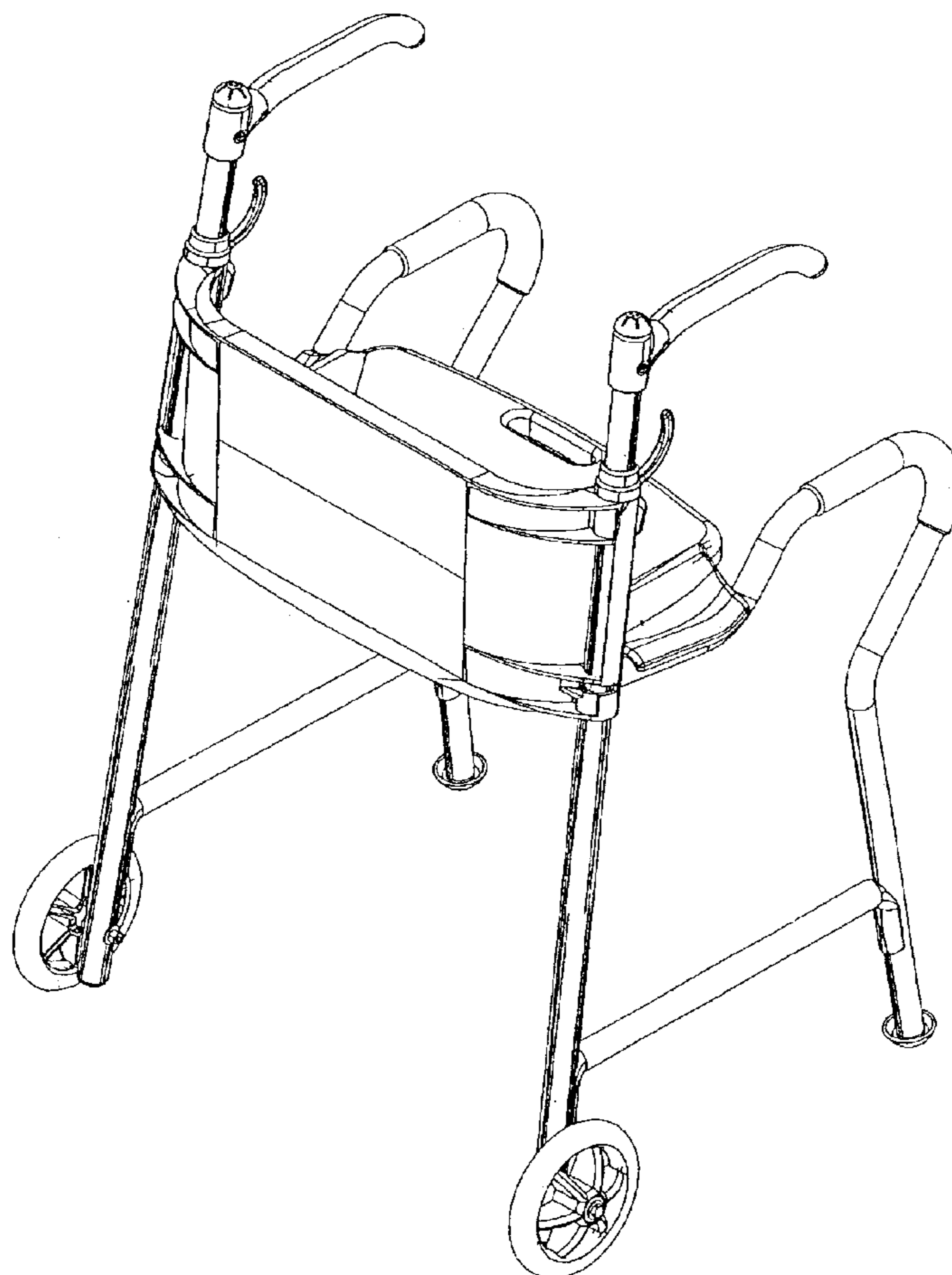

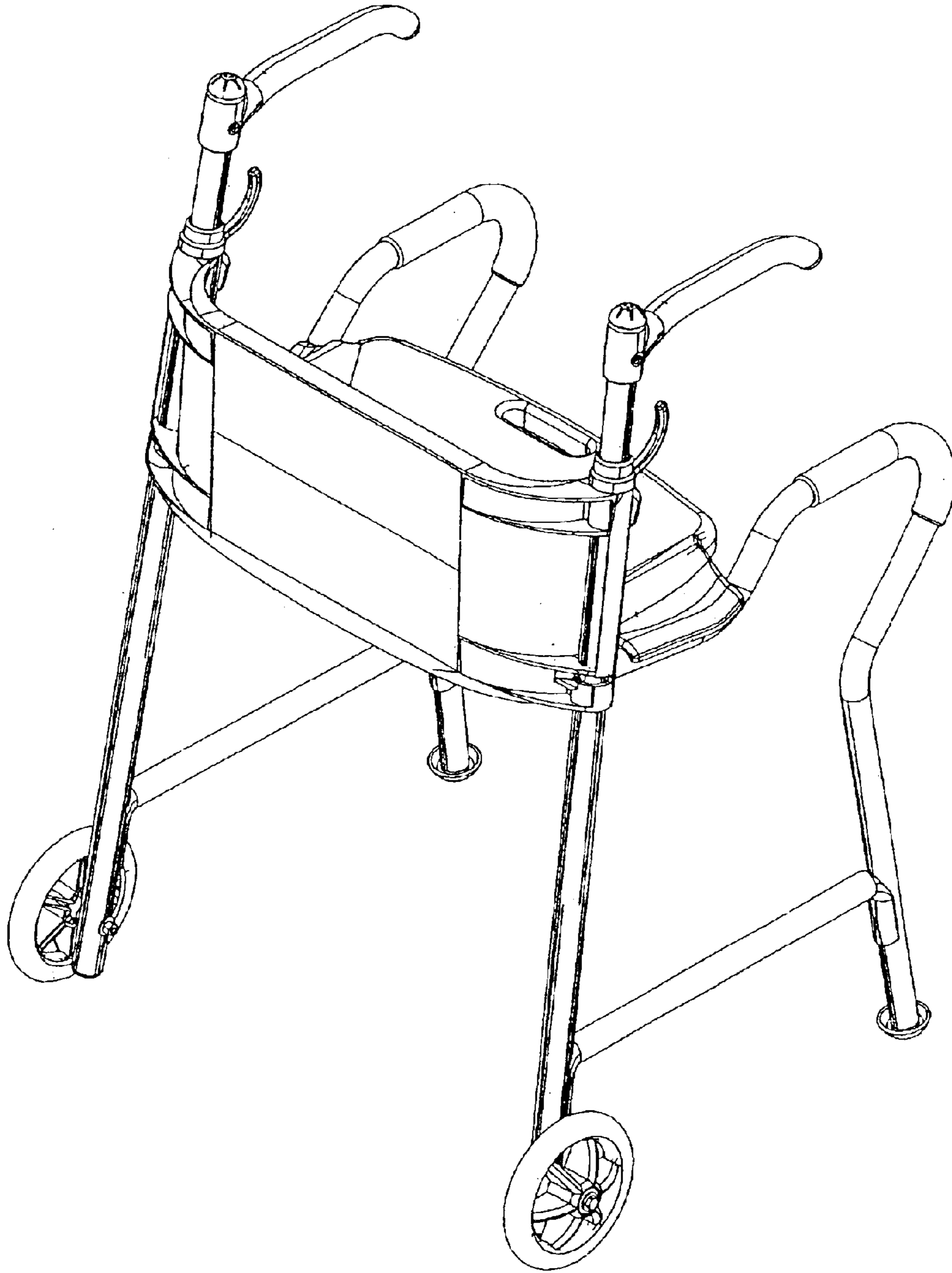

FIG. 1

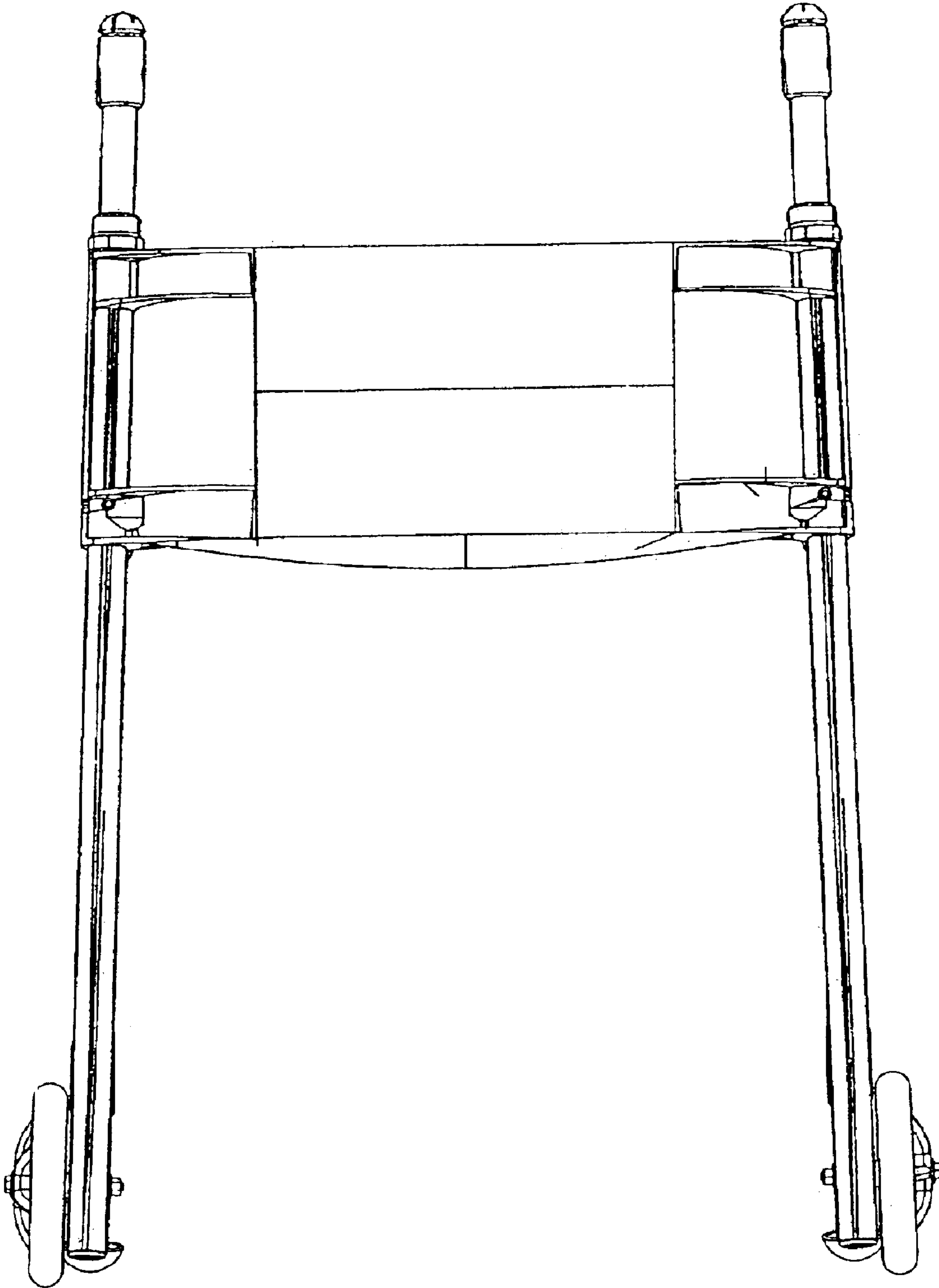

FIG. 2

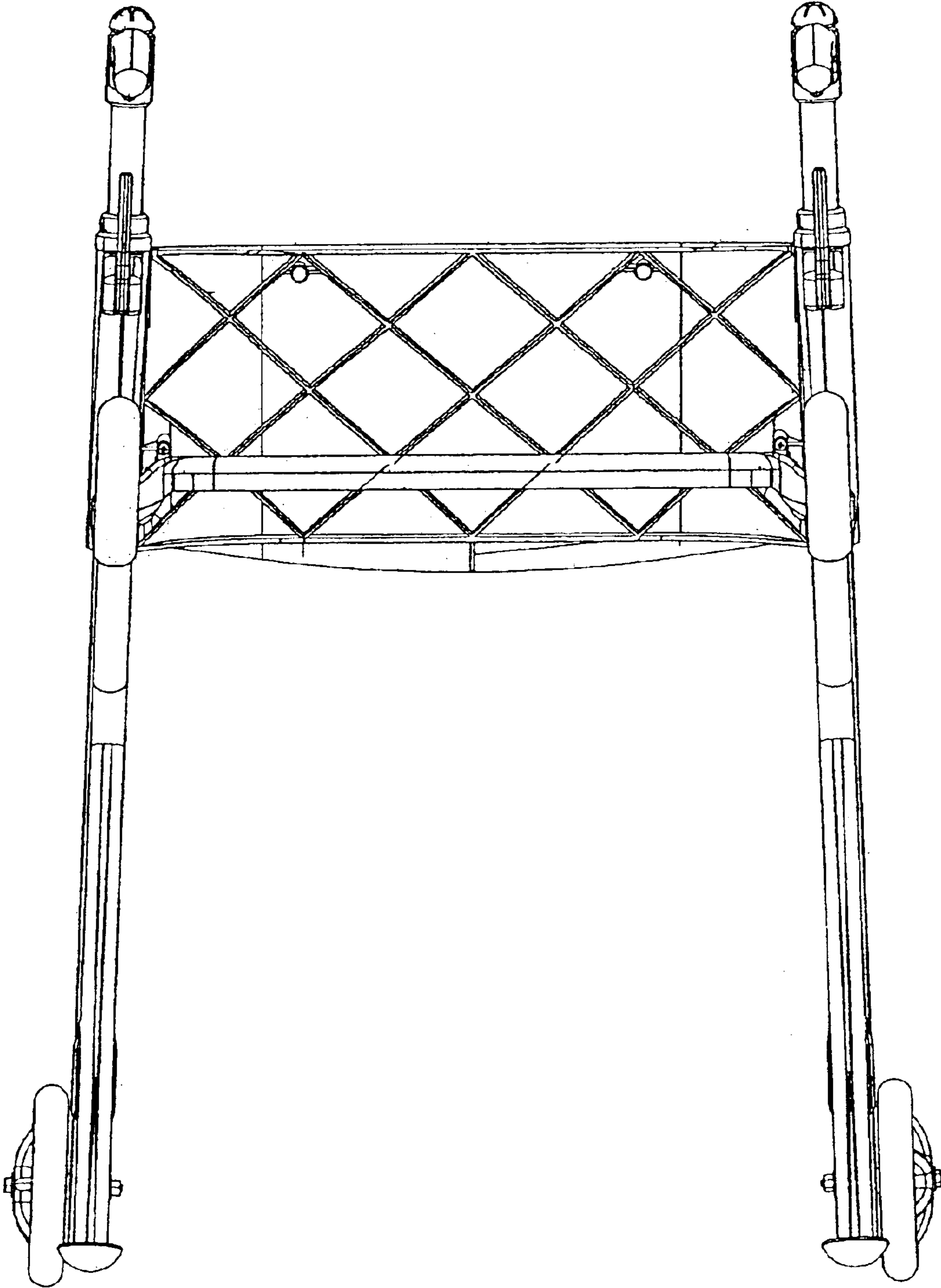

FIG. 3

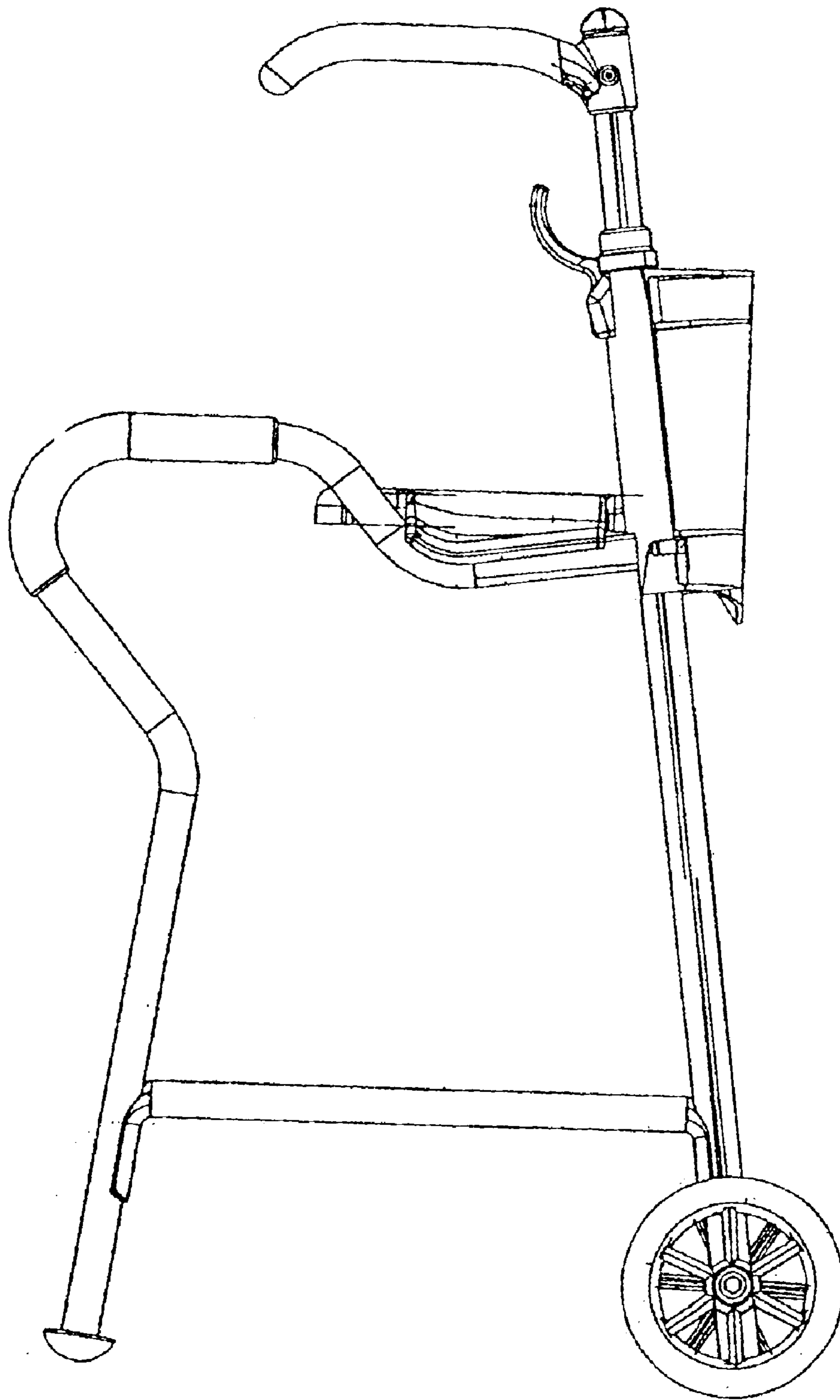

FIG. 4

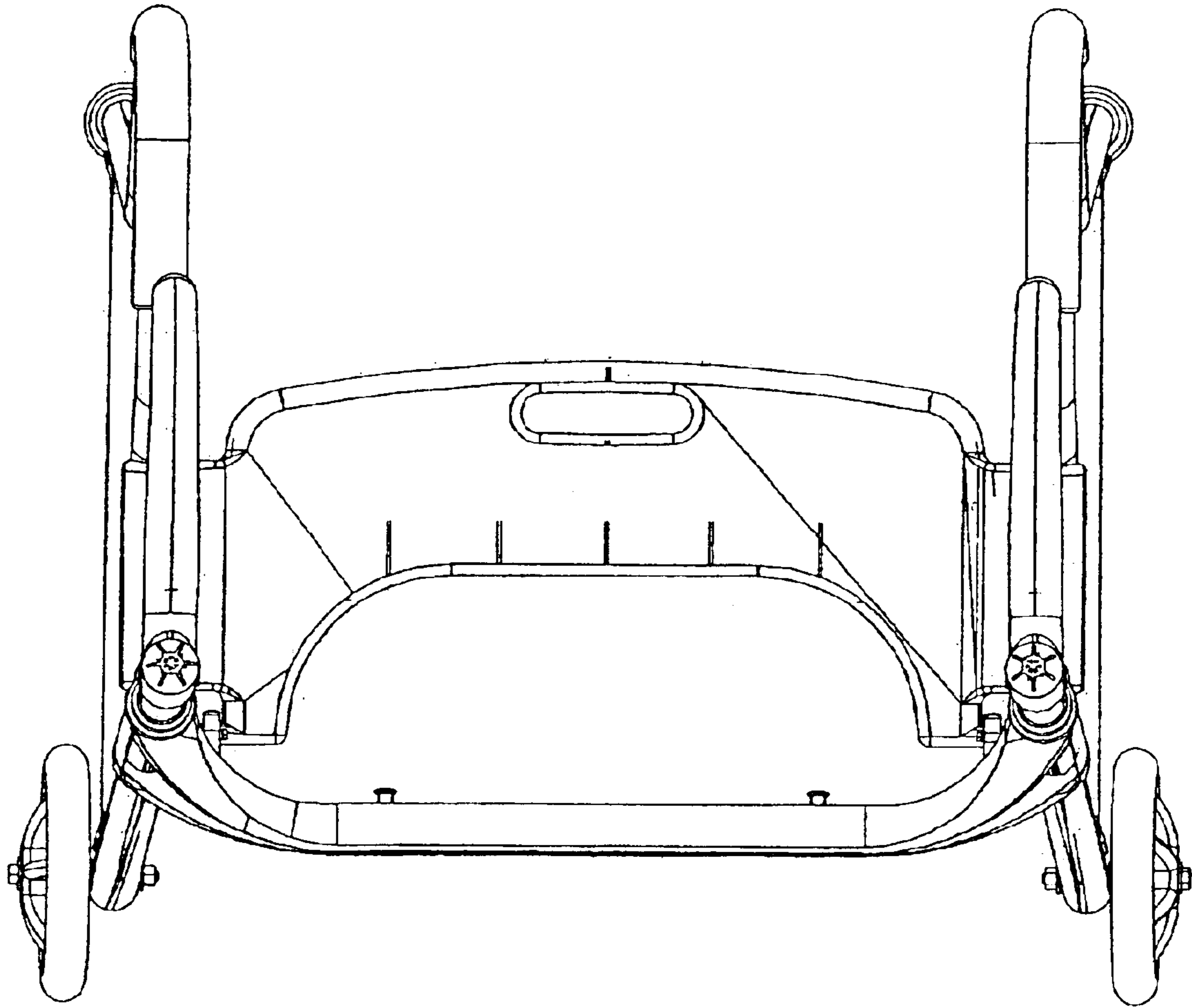

FIG. 5

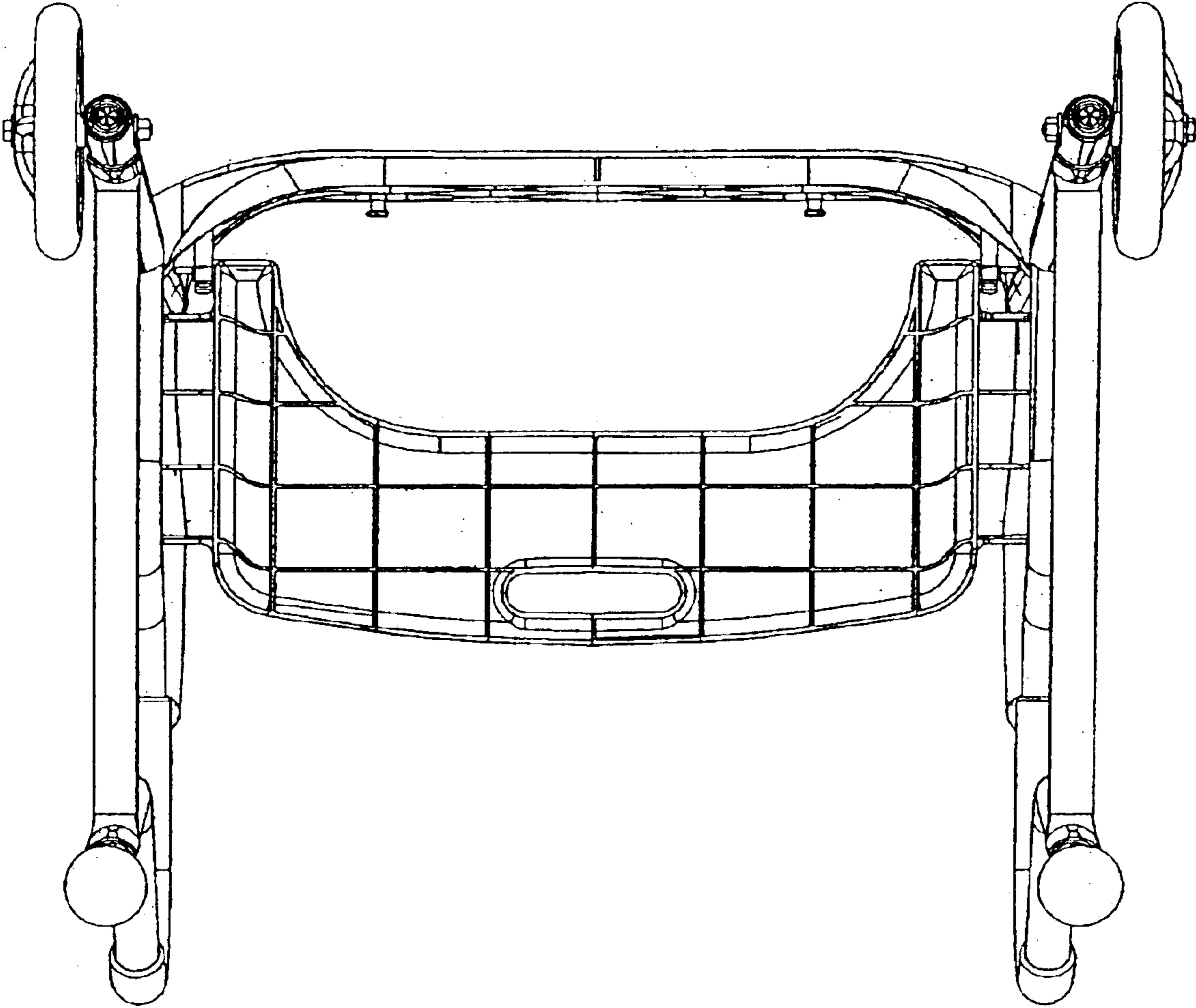

FIG. 6

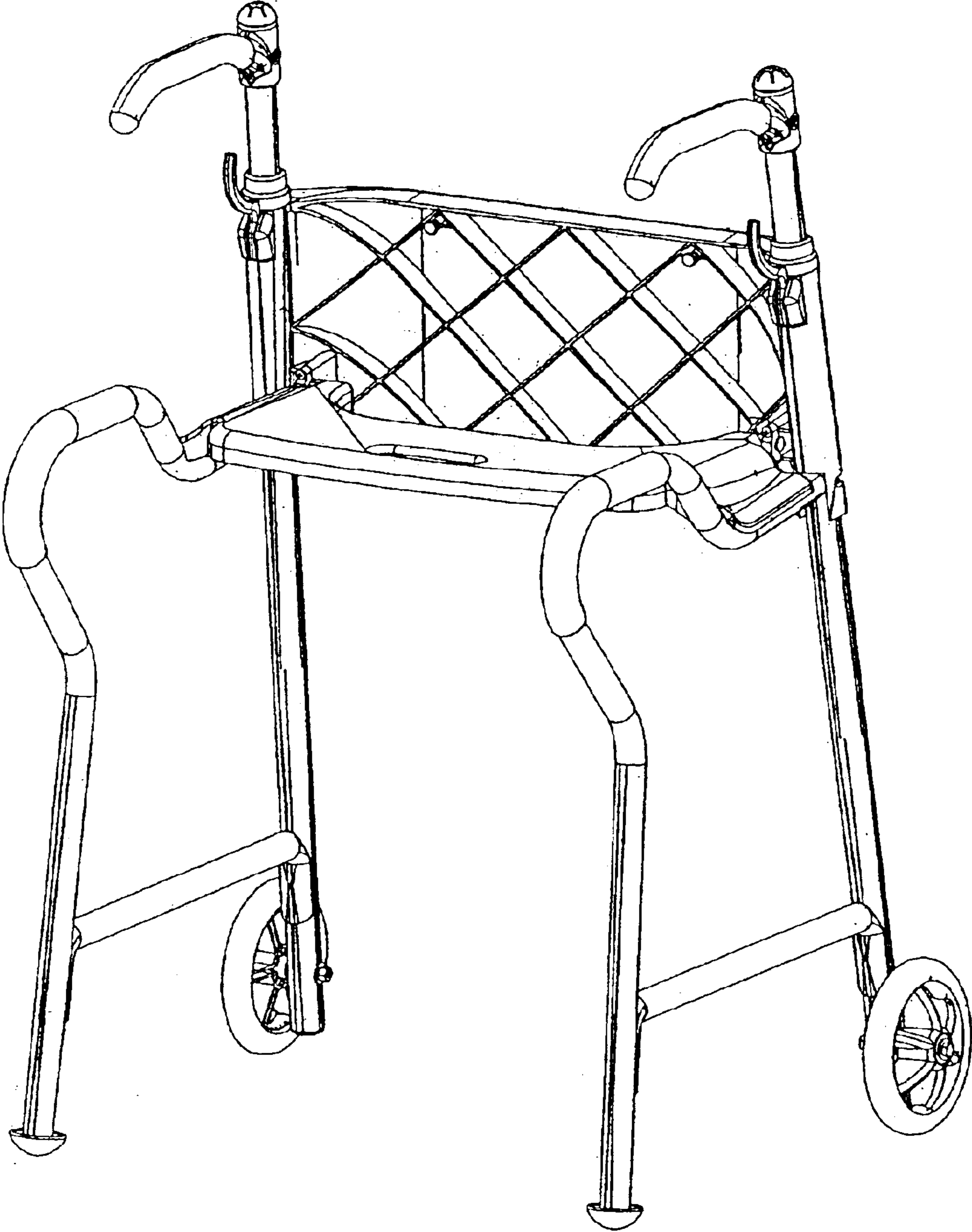

FIG. 7

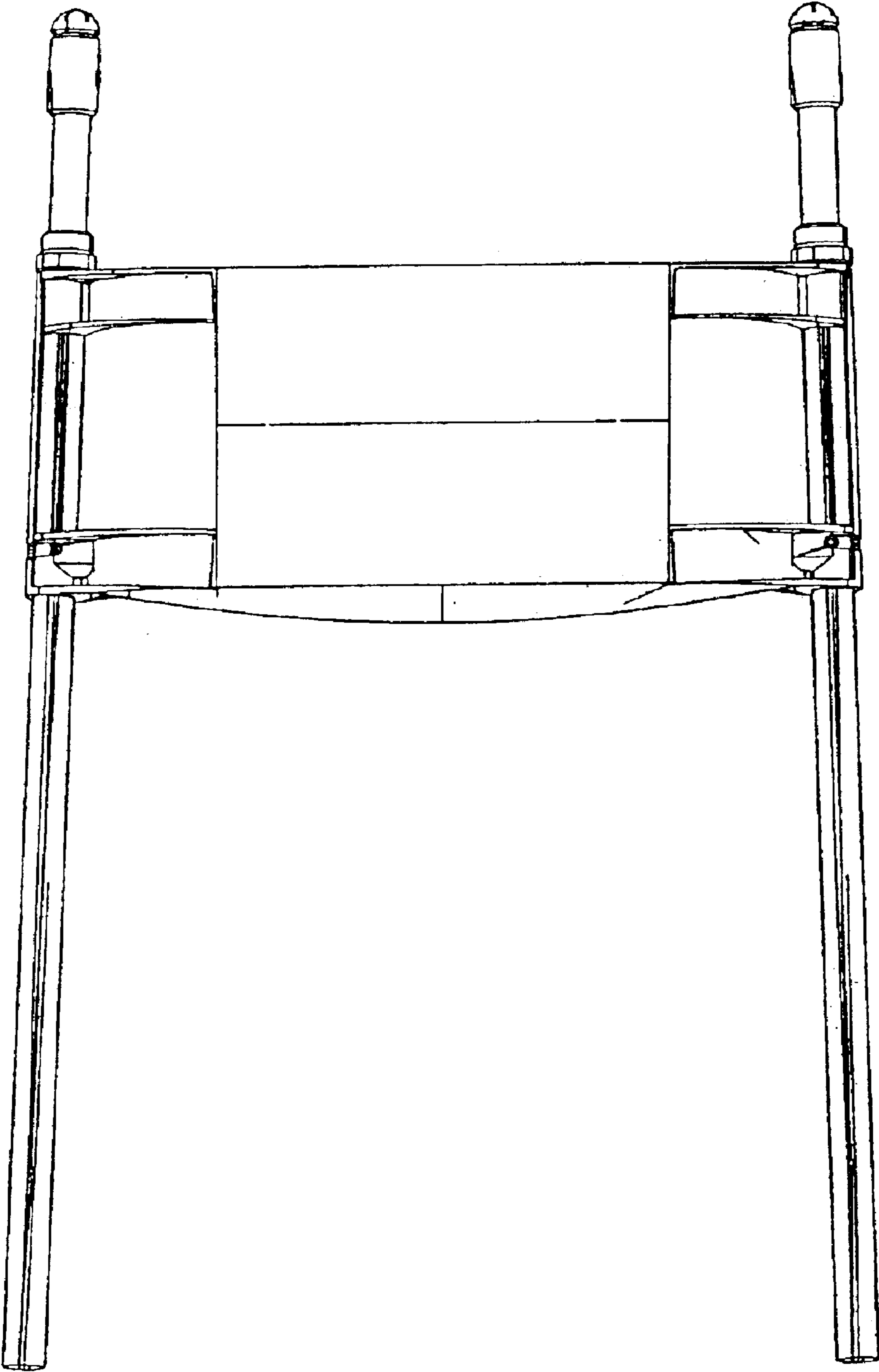

FIG. 8

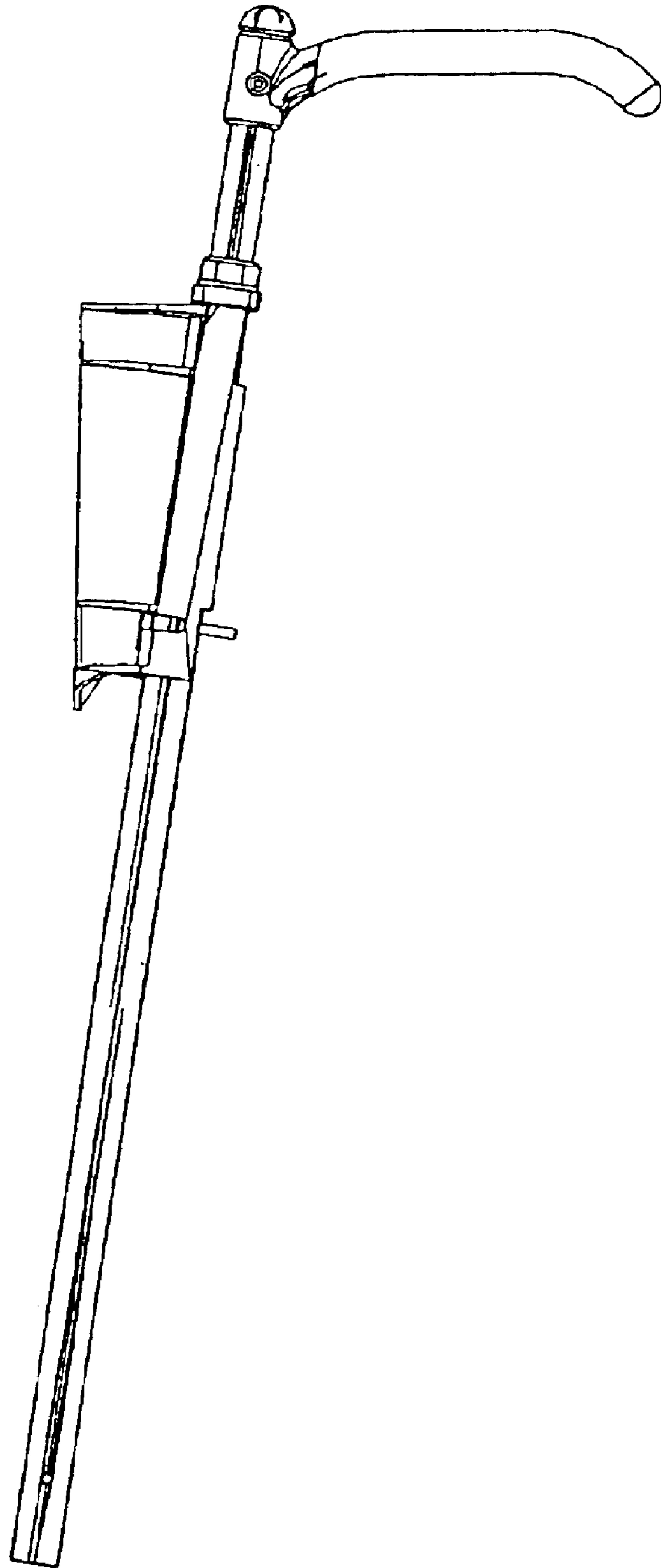

FIG. 9

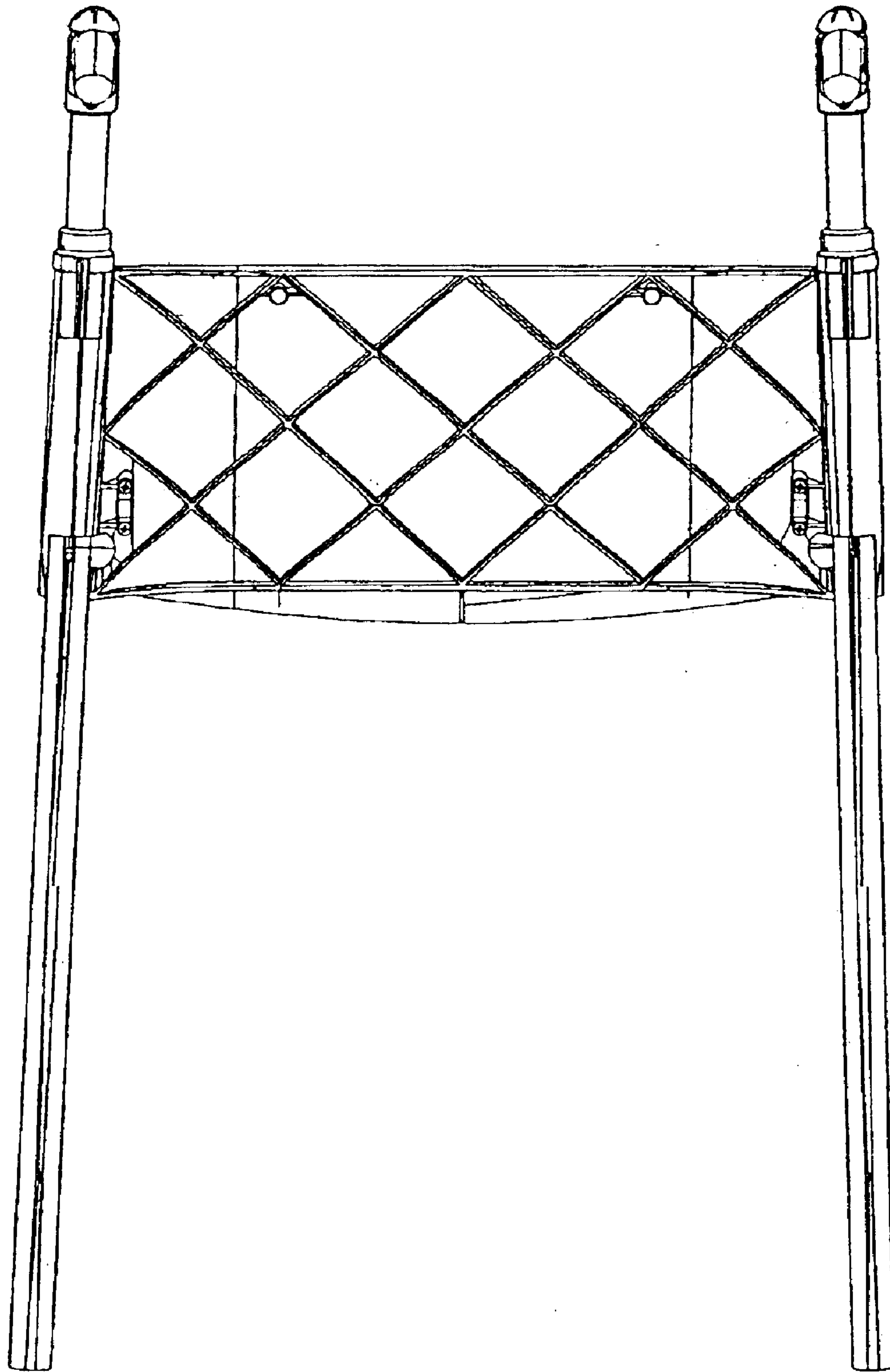

FIG. 10

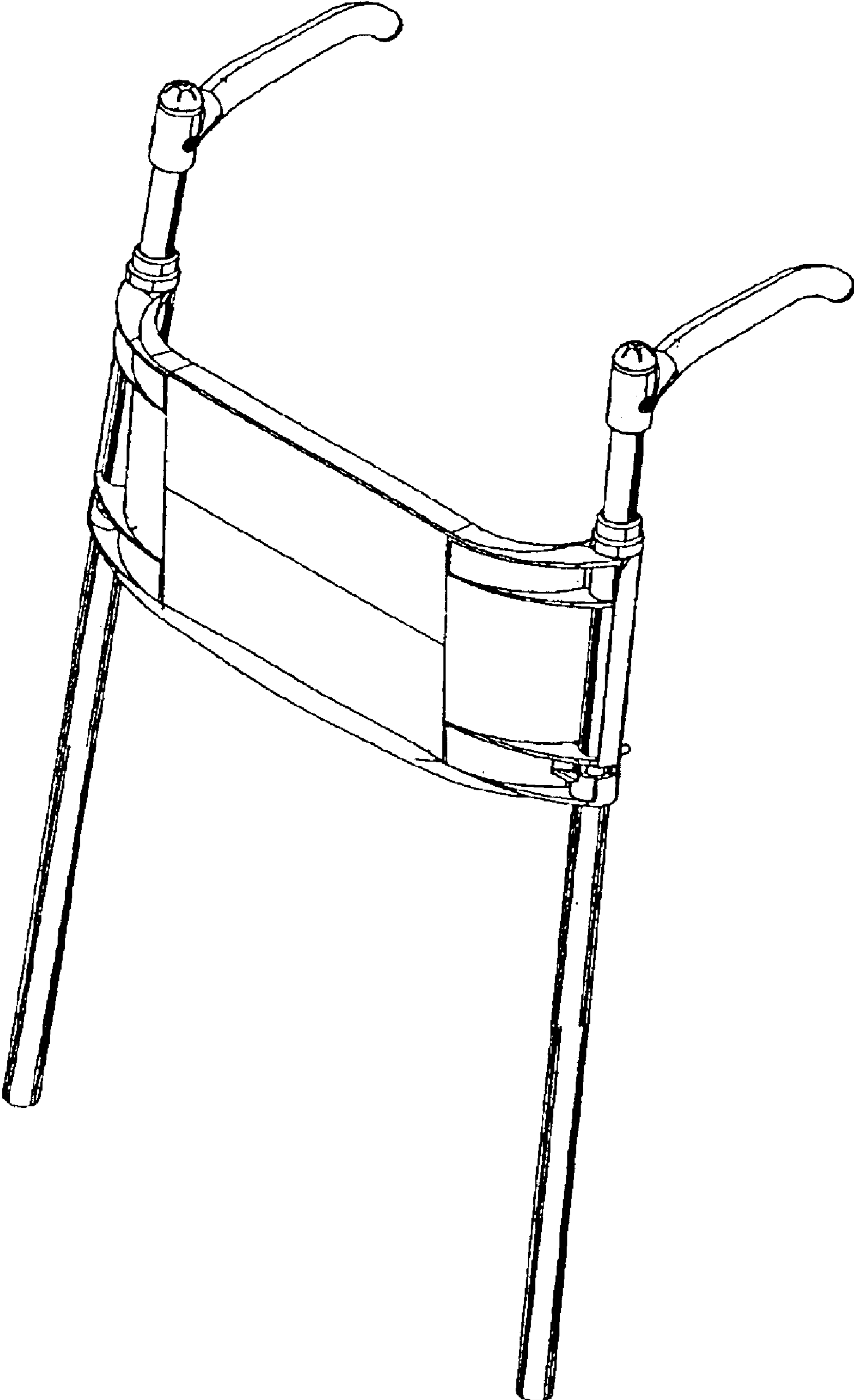

FIG. 11