

US00D494105S1

(12) **United States Design Patent**  
**Hall et al.**

(10) **Patent No.:** **US D494,105 S**

(45) **Date of Patent:** **\*\* Aug. 10, 2004**

(54) **VEHICLE**

(75) Inventors: **Jarad William Hall**, Manhattan Beach, CA (US); **Mami Endo**, Redondo Beach, CA (US); **Joshua Targownik**, Los Angeles, CA (US); **John Andrew Frye**, San Pedro, CA (US); **Donald Lariviere**, Whittier, CA (US); **Don Herner**, Anahiem Hills, CA (US); **Aimee Renee Sadle**, Pasadena, CA (US); **Thomas Hahn Kim**, Reseda, CA (US)

(73) Assignee: **Potex Toys Manufacturer Ltd.**, Kwai Chung (HK)

(\*\*) Term: **14 Years**

(21) Appl. No.: **29/190,103**

(22) Filed: **Sep. 19, 2003**

(51) **LOC (7) Cl.** ..... **12-08**

(52) **U.S. Cl.** ..... **D12/98**

(58) **Field of Search** ..... D12/98, 93; 296/183, 296/185, 186, 37.6, 24.1

(56) **References Cited**

**U.S. PATENT DOCUMENTS**

D474,716 S \* 5/2003 Wakao ..... D12/91

D479,158 S \* 9/2003 Hayashi et al. .... D12/98  
D481,333 S \* 10/2003 Fukushima ..... D12/98  
D481,656 S \* 11/2003 Fukushima ..... D12/98

\* cited by examiner

*Primary Examiner*—Melody N. Brown  
(74) *Attorney, Agent, or Firm*—Alix, Yale & Ristas, LLP

(57) **CLAIM**

The ornamental design for a vehicle, as shown and described.

**DESCRIPTION**

FIG. 1 is a front perspective view of the vehicle showing our new design;

FIG. 2 is a front elevational view thereof;

FIG. 3 is a side elevational view thereof, the opposite side being a mirror image;

FIG. 4 is a rear elevational view thereof;

FIG. 5 is a rear perspective view thereof; and,

FIG. 6 is a top plan view thereof.

The broken line showings of the wheels, tires and rectangular area in the front grille are for illustrative purposes only and form no part of the claimed invention.

**1 Claim, 4 Drawing Sheets**

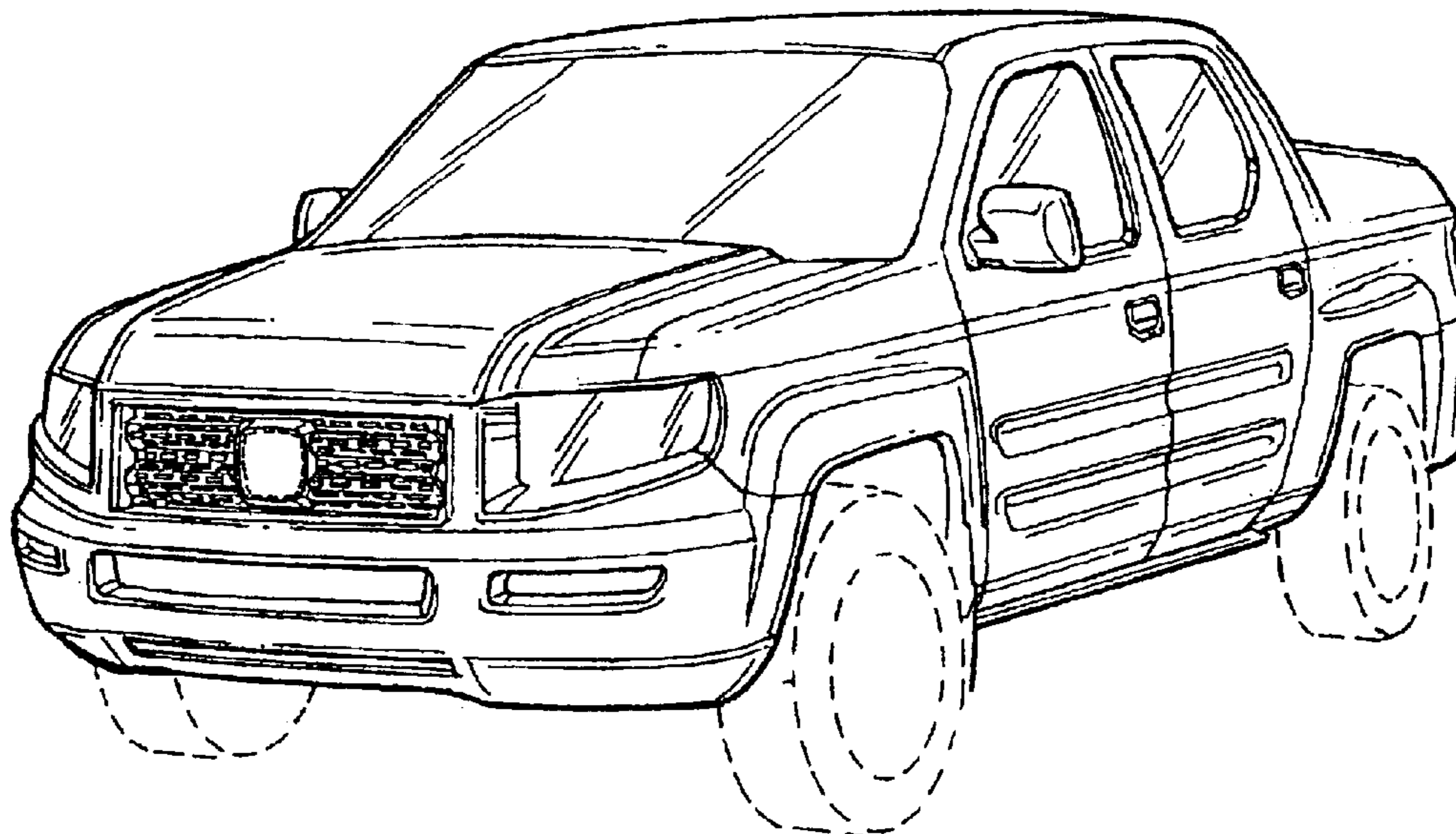

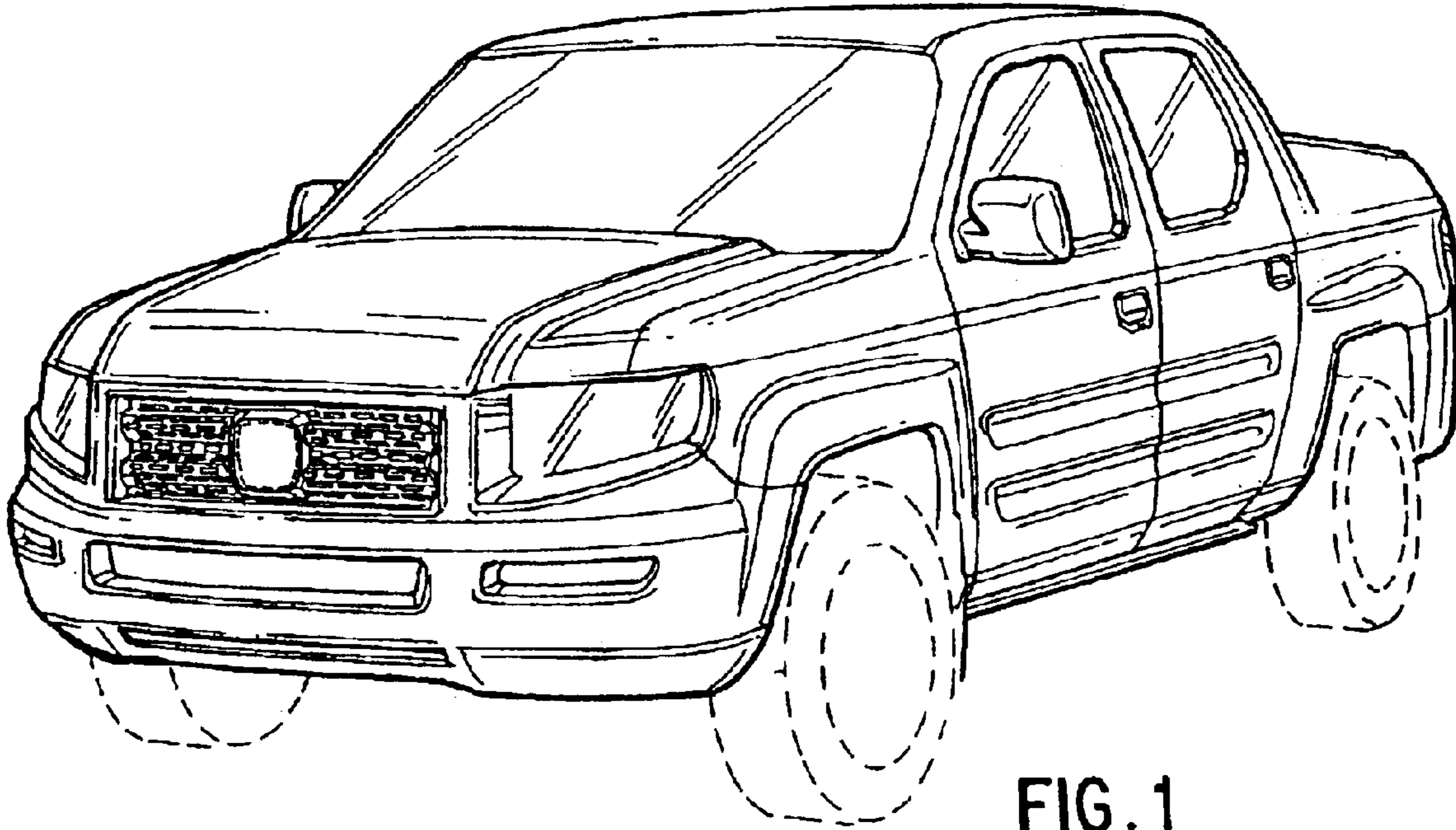

FIG. 1

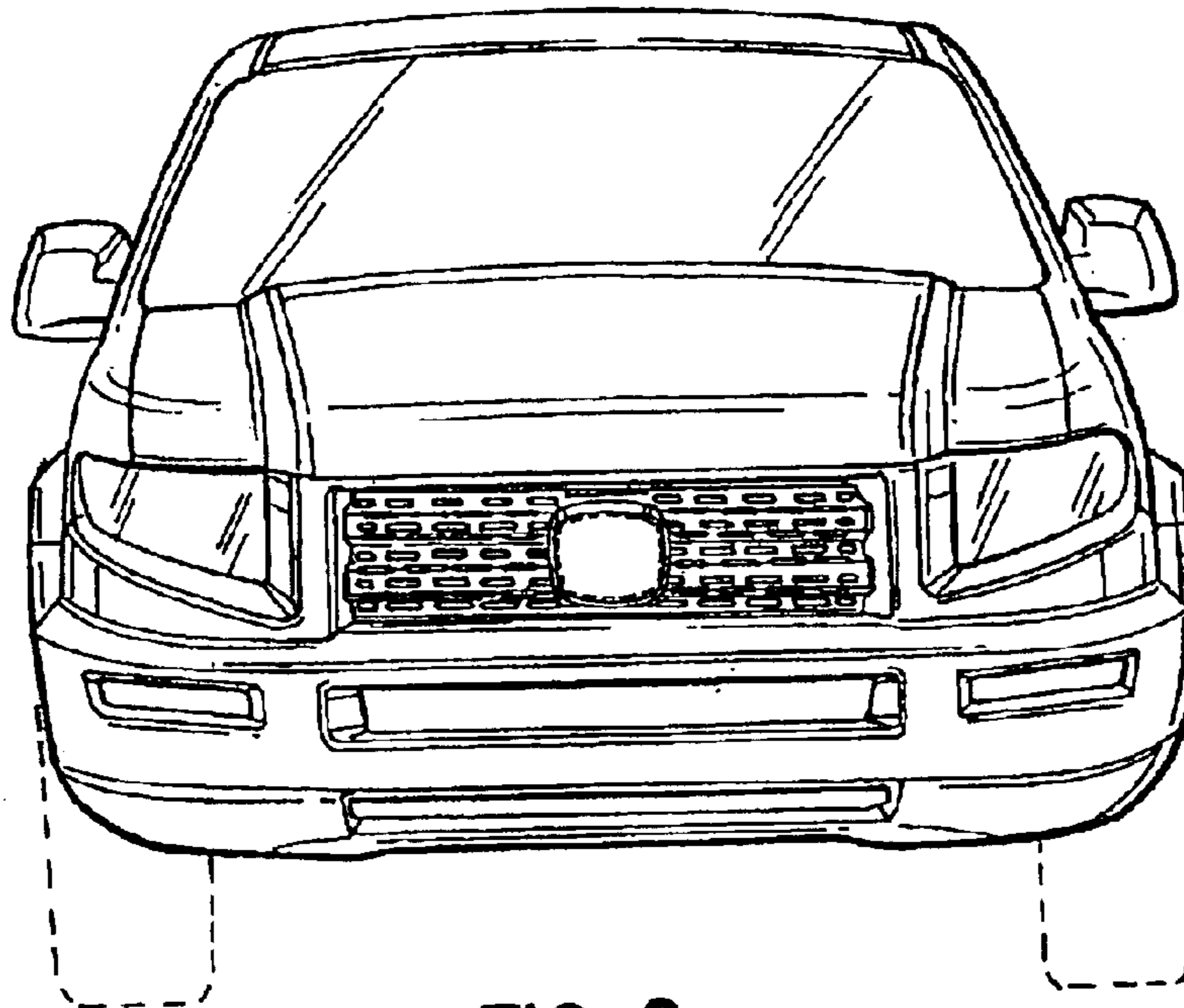

FIG. 2

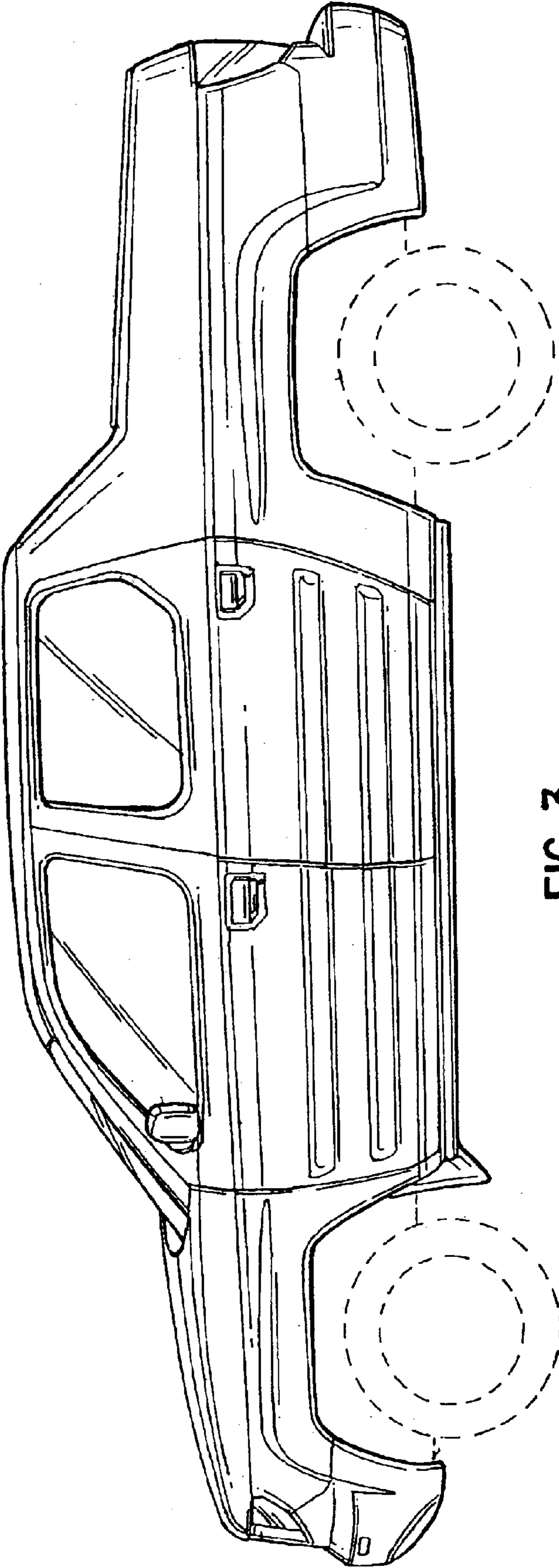

FIG. 3

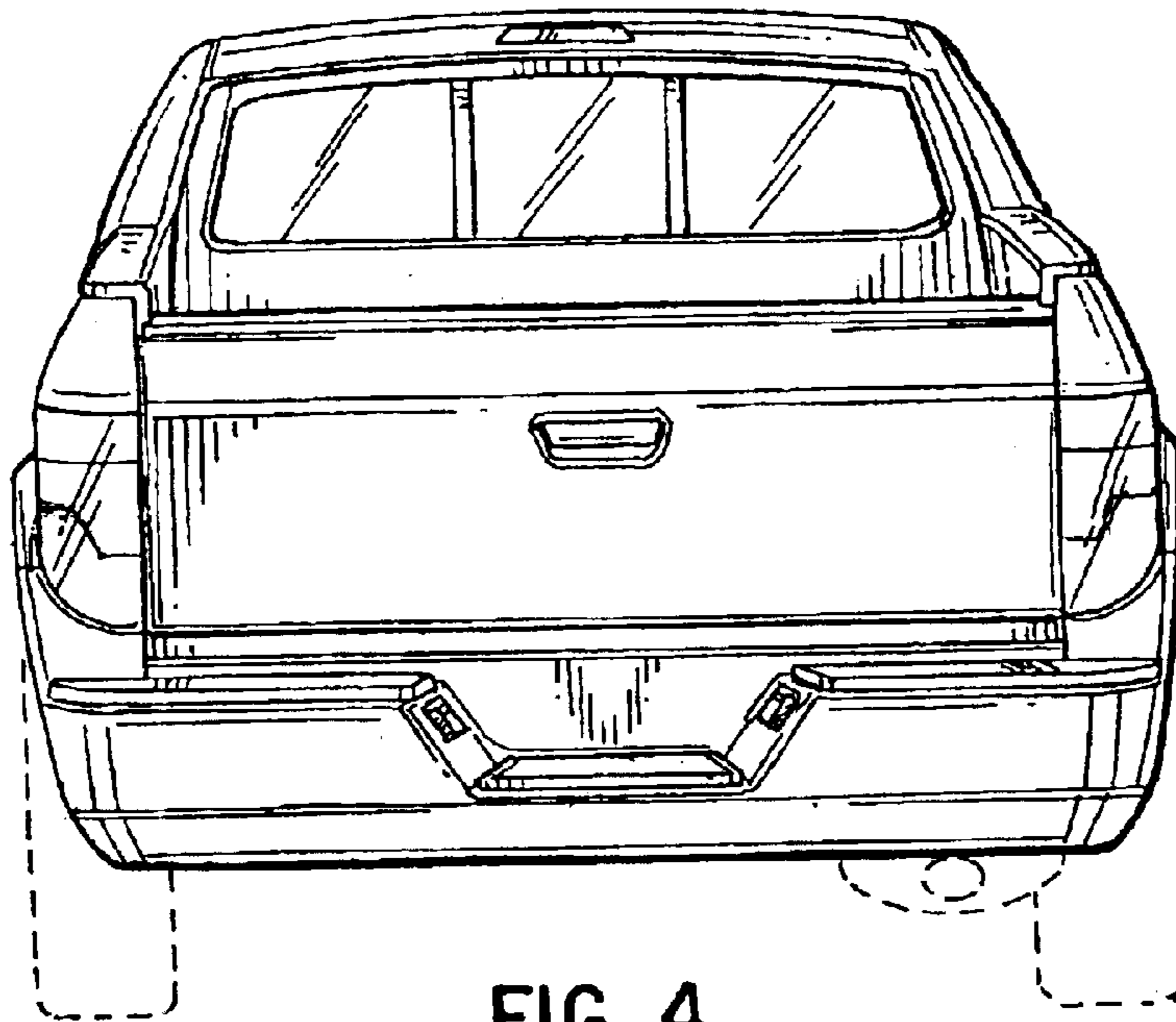

FIG. 4

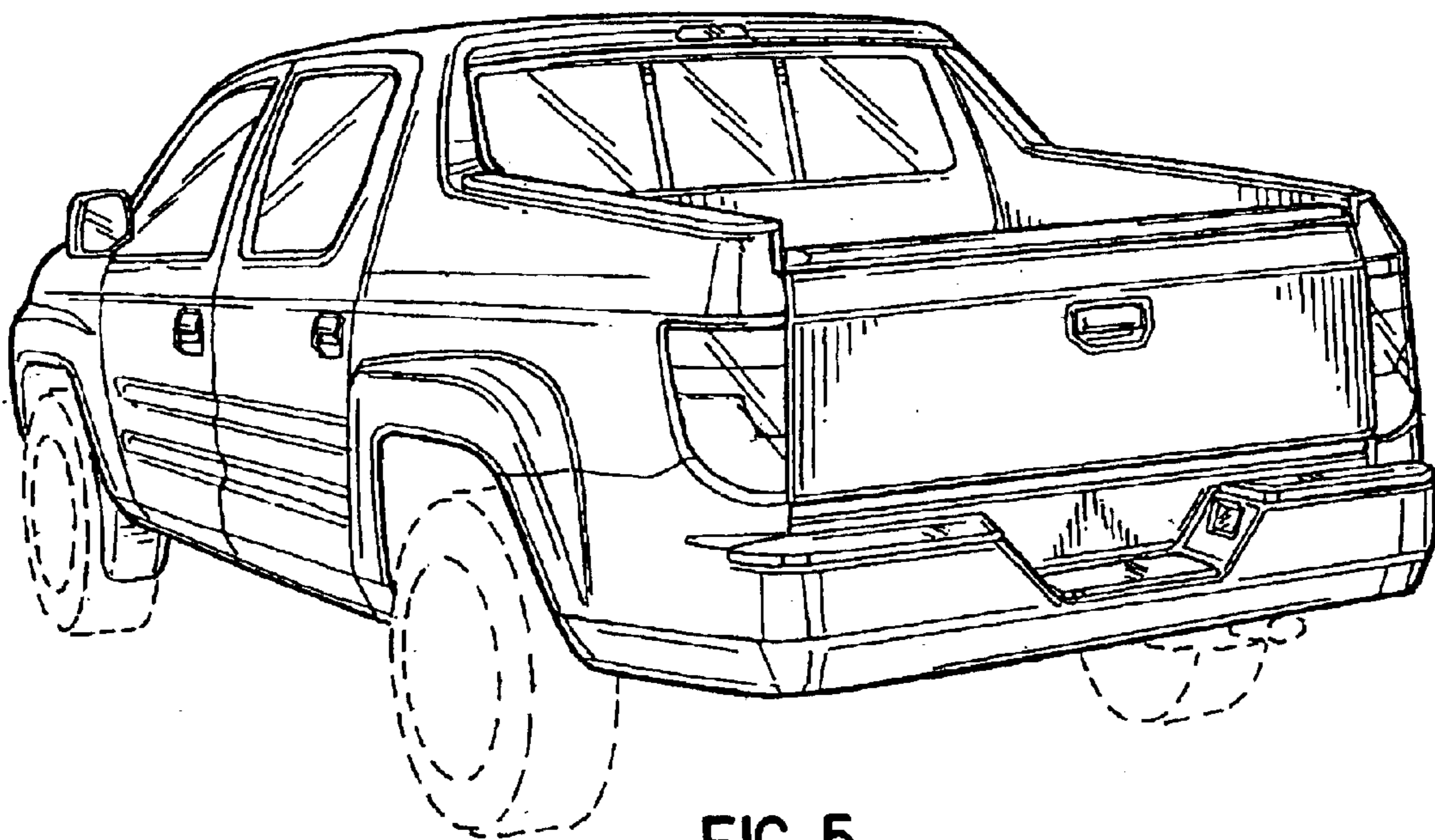

FIG. 5

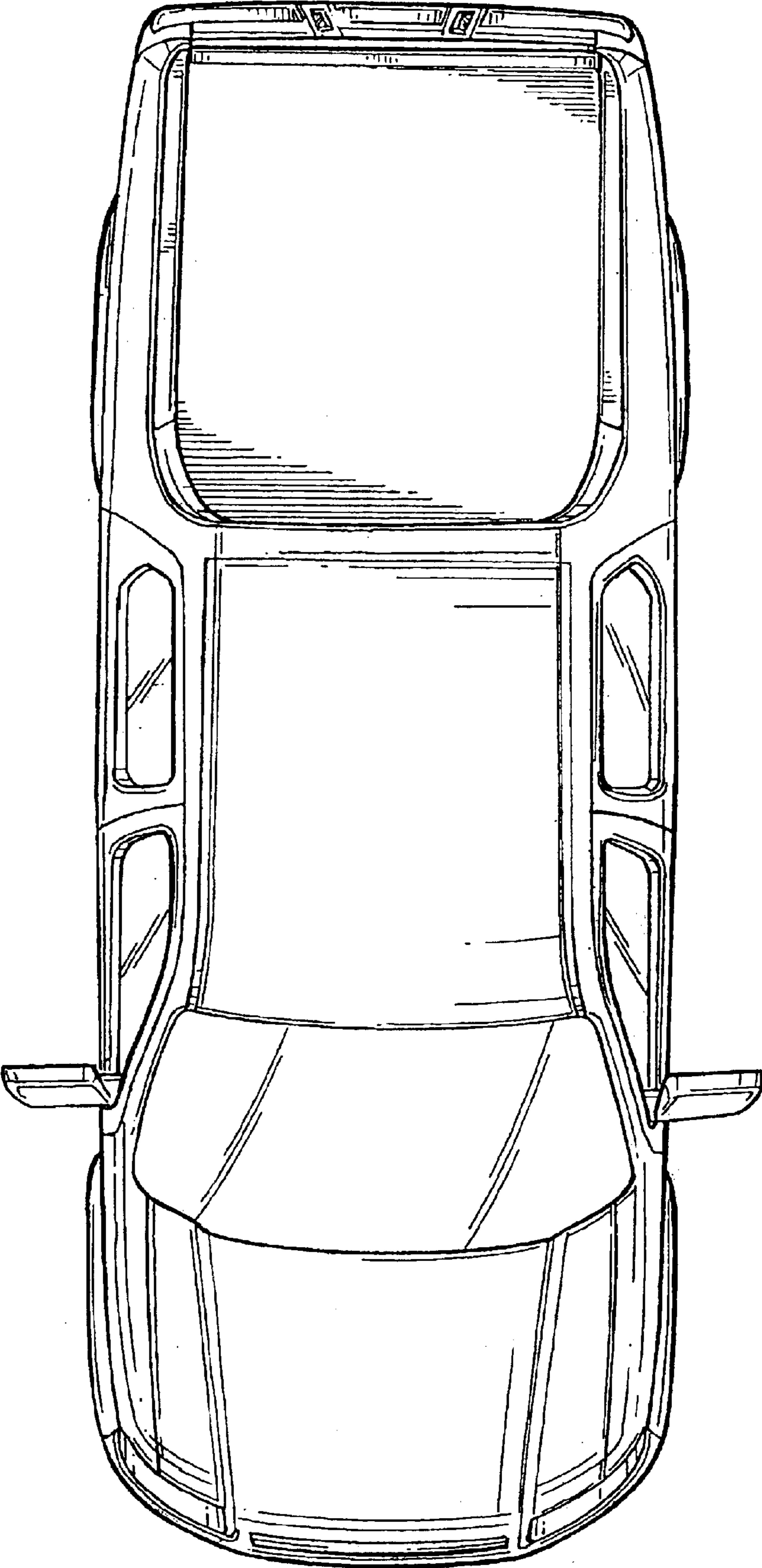

FIG. 6

UNITED STATES PATENT AND TRADEMARK OFFICE  
**CERTIFICATE OF CORRECTION**

PATENT NO. : Des. 494,105 S  
DATED : August 10, 2004  
INVENTOR(S) : Jarad W. Hall et al.

Page 1 of 1

It is certified that error appears in the above-identified patent and that said Letters Patent is hereby corrected as shown below:

Title page.

Item [73], Assignee, should read -- **Honda Giken Kogyo Kabushiki Kaisha**, Tokyo, Japan (JP) --.

Item [74], *Attorney, Agent and Firm*, -- Plumsea Law Group, LLC --.

Signed and Sealed this

Twenty-sixth Day of April, 2005

A handwritten signature in black ink that reads "Jon W. Dudas". The signature is written in a cursive style with a large, looped initial "J".

JON W. DUDAS

*Director of the United States Patent and Trademark Office*