

US00D494022S1

(12) **United States Design Patent**  
**Bodum**

(10) **Patent No.:** **US D494,022 S**

(45) **Date of Patent:** **\*\* Aug. 10, 2004**

(54) **VACUUM BOTTLE**

(75) **Inventor:** **Jørgen Bodum, St. Niklausen (CH)**

(73) **Assignee:** **PI-Design AG, Triengen (CH)**

(\*\*) **Term:** **14 Years**

(21) **Appl. No.:** **29/196,396**

(22) **Filed:** **Dec. 30, 2003**

D414,369 S	*	9/1999	Miller	.....	D7/300.1
D431,969 S	*	10/2000	Hurlbut	.....	D7/608
D434,611 S	*	12/2000	Yu	.....	D7/608
D454,760 S	*	3/2002	Hatsumoto	.....	D7/608
D459,158 S	*	6/2002	Tardif et al.	.....	D7/608
D465,385 S	*	11/2002	Miller	.....	D7/523
D472,100 S	*	3/2003	Gullickson et al.	.....	D7/510
D472,107 S	*	3/2003	Short	.....	D7/629
D476,859 S	*	7/2003	Short	.....	D7/608
D480,917 S	*	10/2003	Holsinger et al.	.....	D7/533
D484,743 S	*	1/2004	Furlong	.....	D7/510

\* cited by examiner

**Related U.S. Application Data**

(62) Division of application No. 29/177,298, filed on Mar. 10, 2003.

(30) **Foreign Application Priority Data**

Sep. 12, 2002 (DK) ..... 2002 00719

(51) **LOC (7) Cl.** ..... **07-02**

(52) **U.S. Cl.** ..... **D7/608; D7/300.1**

(58) **Field of Search** ..... **D7/300.1, 510, D7/511, 531, 605, 608; 220/708; 215/229, 307**

(56) **References Cited**

**U.S. PATENT DOCUMENTS**

D246,858 S	*	1/1978	Larson	.....	D24/199
D318,394 S	*	7/1991	Larimer	.....	D7/300.1
5,518,143 A	*	5/1996	Iodice	.....	220/708

*Primary Examiner*—M. N. Pandozzi

(74) *Attorney, Agent, or Firm*—Nath & Associates PLLC

(57) **CLAIM**

The ornamental design for a vacuum bottle, as shown and described.

**DESCRIPTION**

FIG. 1 is an oblique perspective view of the vacuum bottle; FIG. 2 is a front view of the vacuum bottle, as shown in FIG. 1; FIG. 3 is a back view of the vacuum bottle; FIG. 4 is a right side view of the vacuum bottle; FIG. 5 is a left side view of the vacuum bottle; FIG. 6 is a top view of the vacuum bottle; and, FIG. 7 is a bottom view of the vacuum bottle.

**1 Claim, 7 Drawing Sheets**

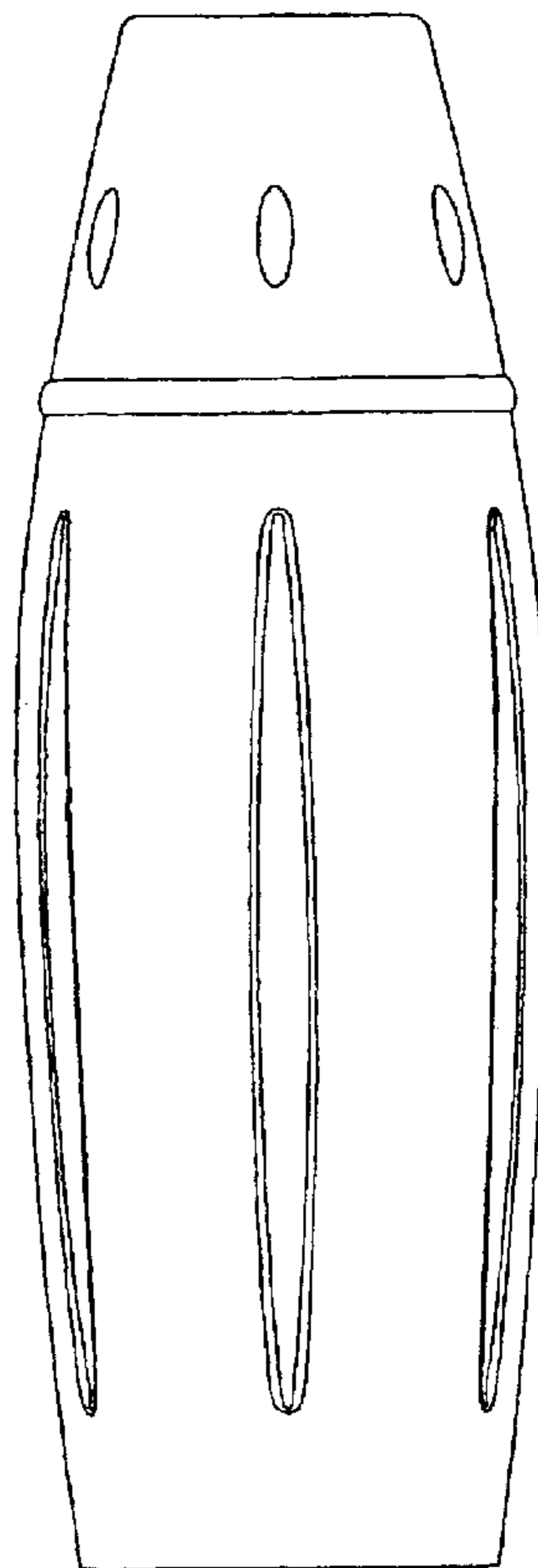

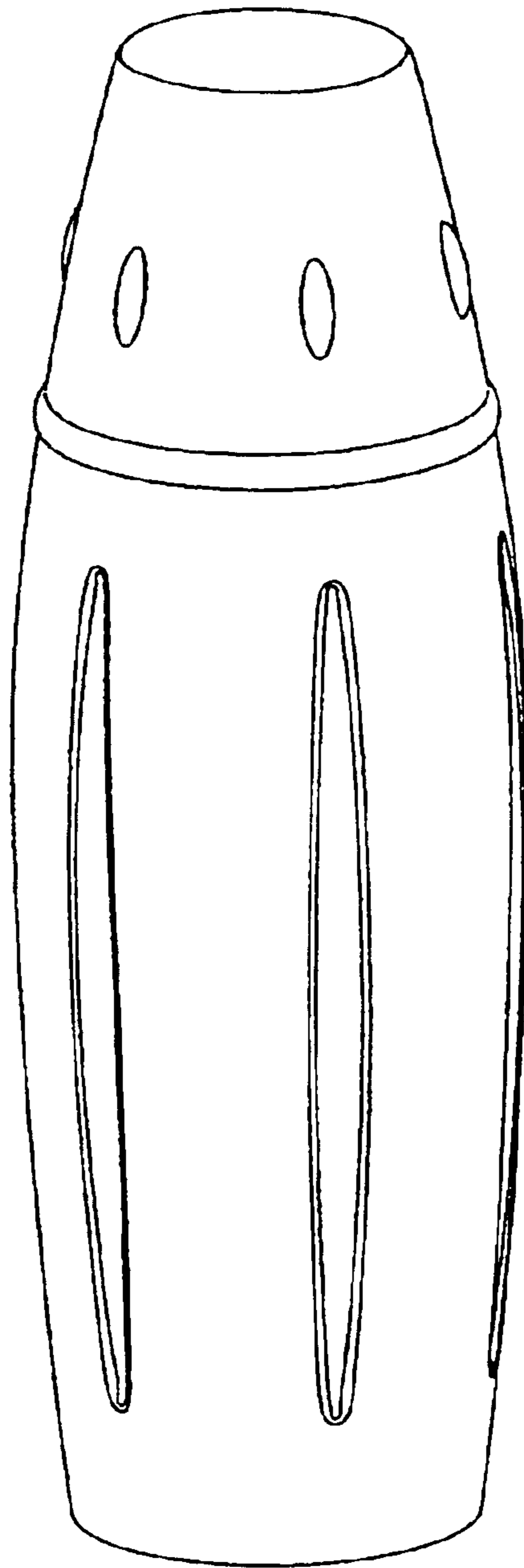

Fig. 1

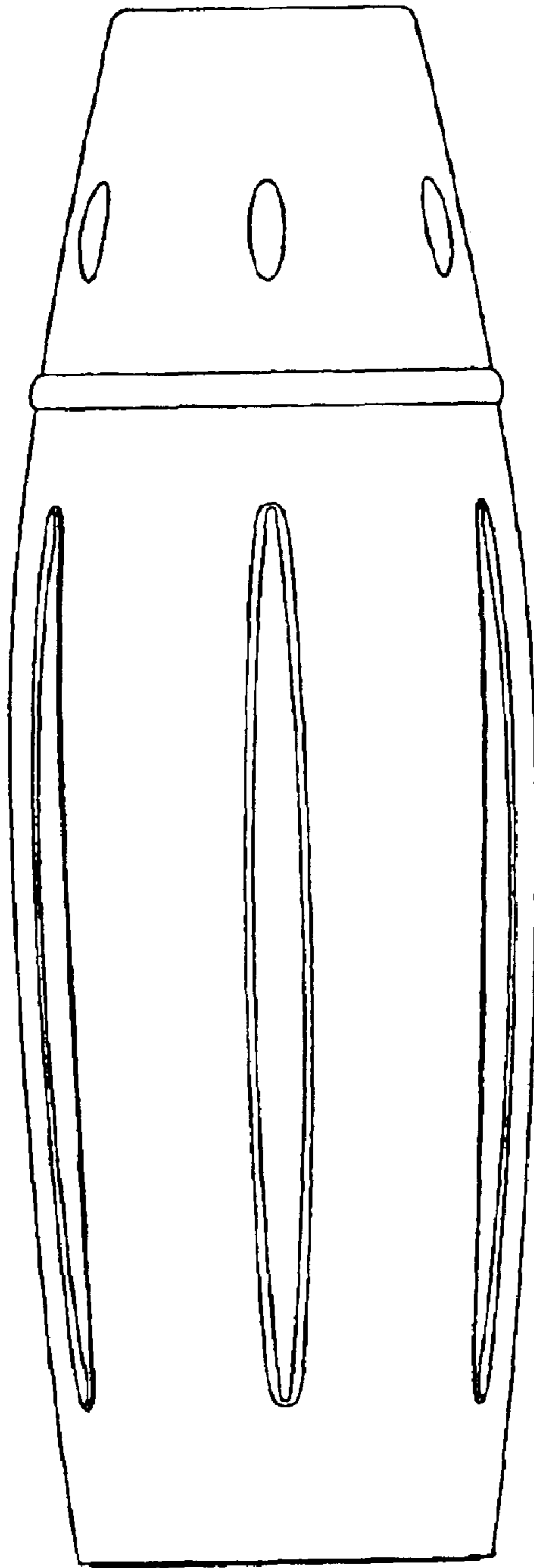

Fig. 2

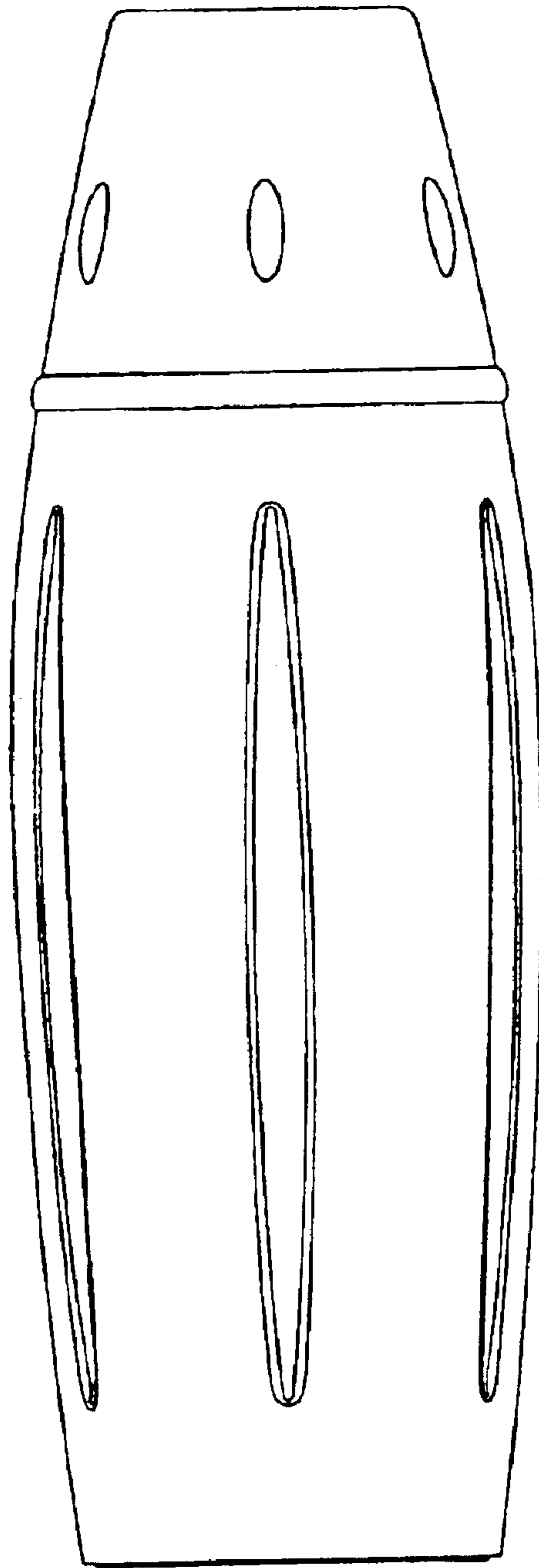

Fig. 3

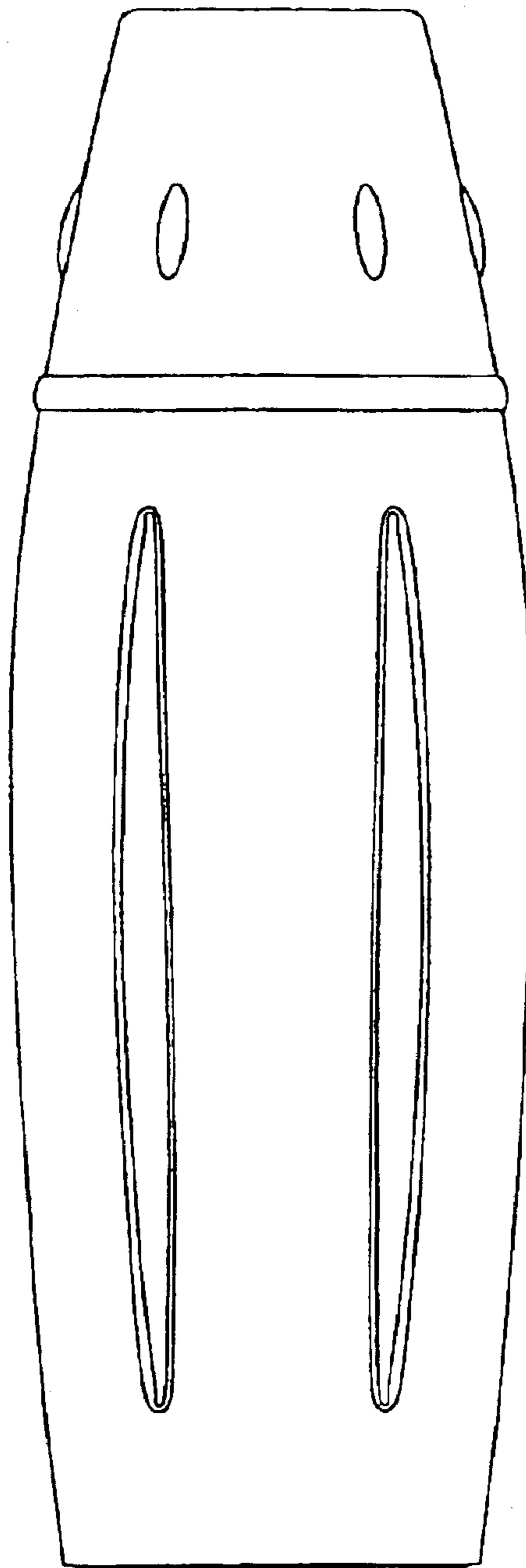

Fig. 4

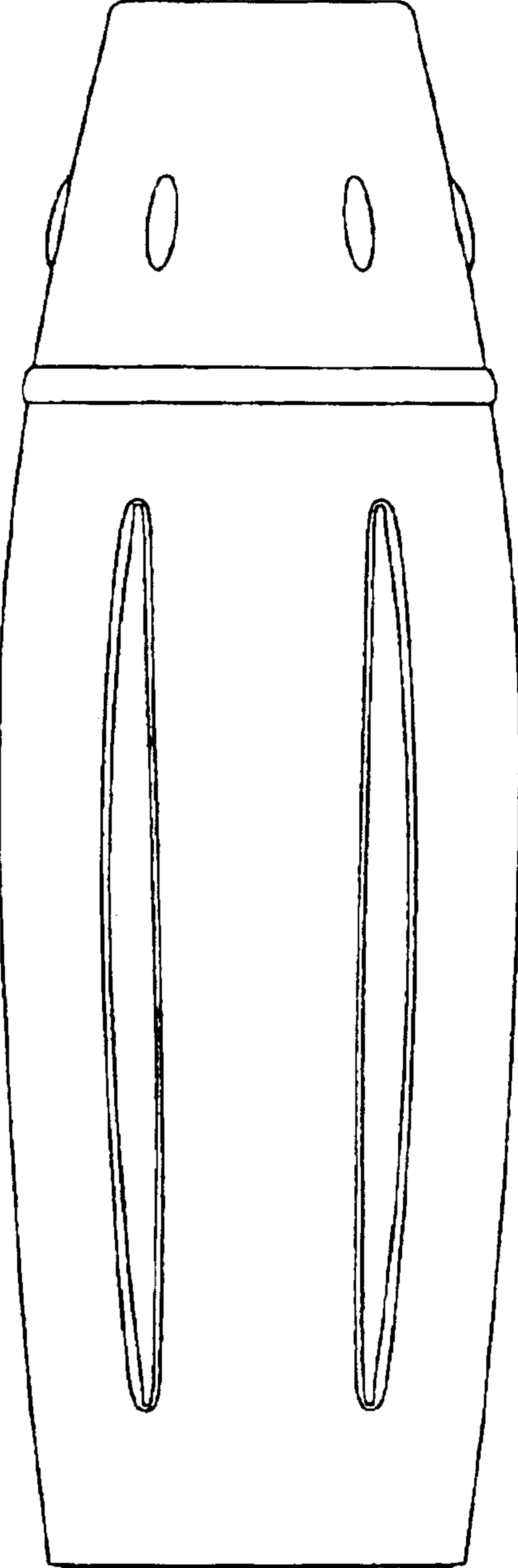

Fig. 5

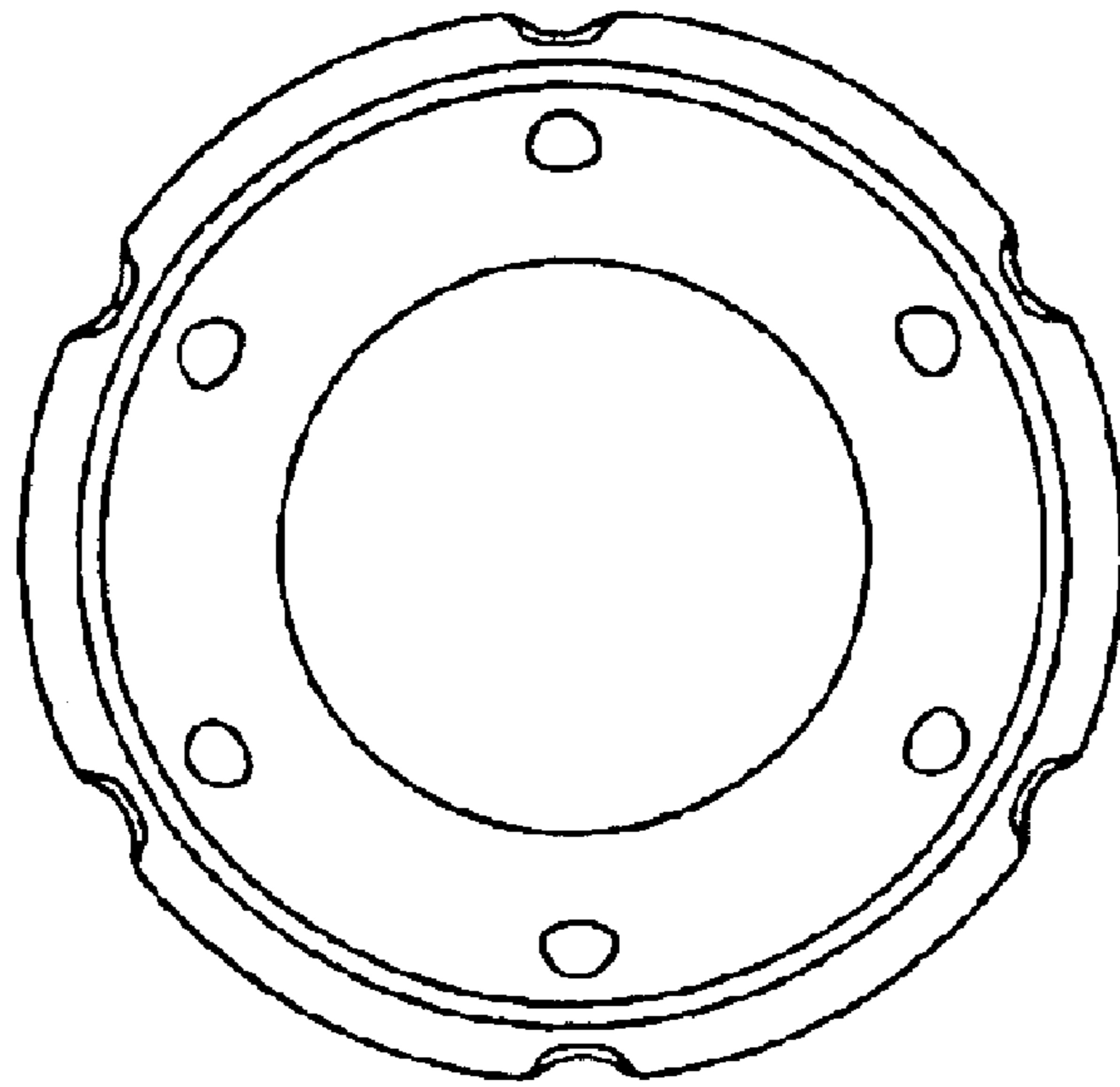

Fig. 6

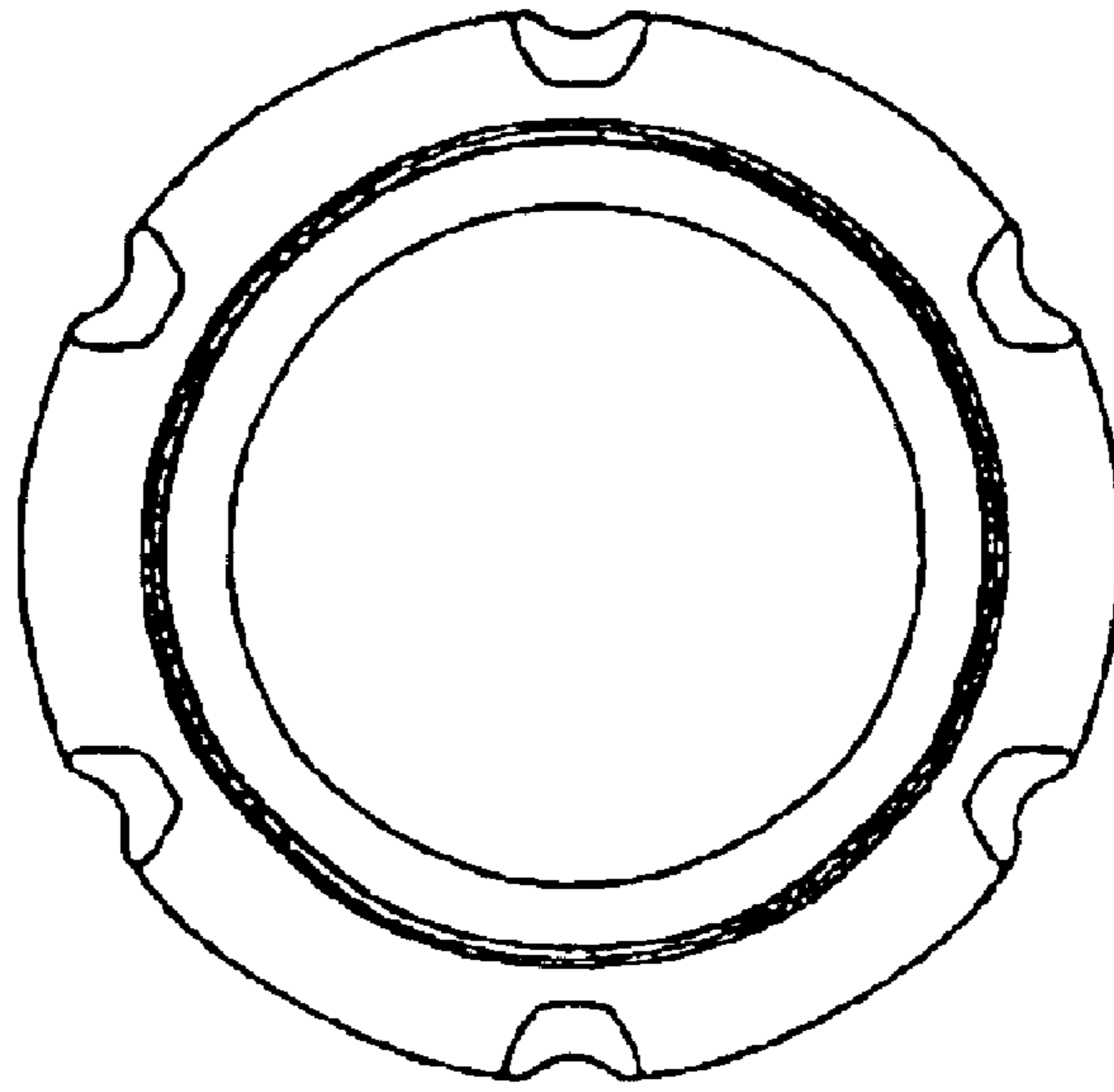

Fig. 7