

US00D494001S1

(12) **United States Design Patent**
Wynalda, Jr. et al.

(10) **Patent No.: US D494,001 S**

(45) **Date of Patent: ** Aug. 10, 2004**

(54) **STORAGE CONTAINER FOR RECORDED MEDIA**

(76) Inventors: **Robert M. Wynalda, Jr.**, 420 9 Mile Rd., NE., Comstock Park, MI (US) 49321; **Ronald M. Marsilio**, 7100 Deer Trail Ave., NE., Canton, OH (US) 44721

(**) **Term: 14 Years**

(21) **Appl. No.: 29/161,688**

(22) **Filed: May 31, 2002**

Related U.S. Application Data

(60) Division of application No. 29/143,680, filed on Jun. 18, 2001, which is a continuation-in-part of application No. 29/137,709, filed on Feb. 28, 2001.

(51) **LOC (7) Cl. 06-04**

(52) **U.S. Cl. D6/634; D6/407; D6/631; D6/635**

(58) **Field of Search** D3/201, 217, 218, D3/226, 238, 247, 254, 257, 270, 272, 273, 276, 295, 303, 307; D6/407, 408, 475, 626-635; D9/337, 424, 445, 454; 206/18, 307, 307.1, 308.1, 308.2, 308.3, 309-310, 311, 312, 313, 445, 749; 312/902, 9.9, 9.48, 9.55, 9.64, 9.47, 9.53, 328; 379/355; 383/18

(56) **References Cited**

U.S. PATENT DOCUMENTS

D362,367 S * 9/1995 Olsson et al. D6/632
5,593,030 A * 1/1997 Tell 206/308.1

D378,333 S * 3/1997 Anderson D6/632
5,651,458 A * 7/1997 Brosmith et al. 206/308.1
5,772,018 A * 6/1998 Walch 206/308.1
D420,240 S * 2/2000 Sorenson et al. D6/632
6,092,650 A * 7/2000 Budnik 206/232
D431,955 S * 10/2000 Peterson et al. D6/632
D433,266 S * 11/2000 Peterson et al. D6/634
6,283,283 B1 * 9/2001 Rufo, Jr. et al. 206/308.1
D452,105 S * 12/2001 Chan D6/635
D452,793 S * 1/2002 Lee D6/632
D453,081 S * 1/2002 Yu D6/407
D463,944 S * 10/2002 Wynalda, Jr. et al. D6/635

* cited by examiner

Primary Examiner—Celia Murphy

(74) *Attorney, Agent, or Firm*—Sand & Sebolt

(57) **CLAIM**

The ornamental design for storage container for recorded media, as shown and described.

DESCRIPTION

FIG. 1 is a perspective view of the storage container for recorded media showing our new design, the storage container for recorded media being in a closed configuration.

FIG. 2 is a perspective view of the storage container for recorded media showing our new design, the storage container being in an open configuration.

FIG. 3 is a front elevation view of FIG. 2.

FIG. 4 is a left side elevation view of FIG. 3.

FIG. 5 is a top plan view of FIG. 3; and,

FIG. 6 is a bottom plan view of FIG. 3.

The broken lines are for illustrative purposes only and form no part of the claimed design.

1 Claim, 6 Drawing Sheets

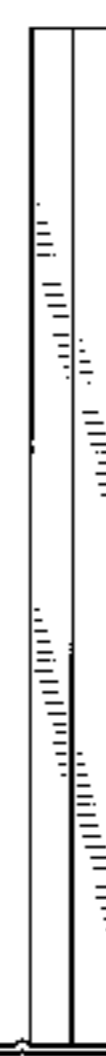
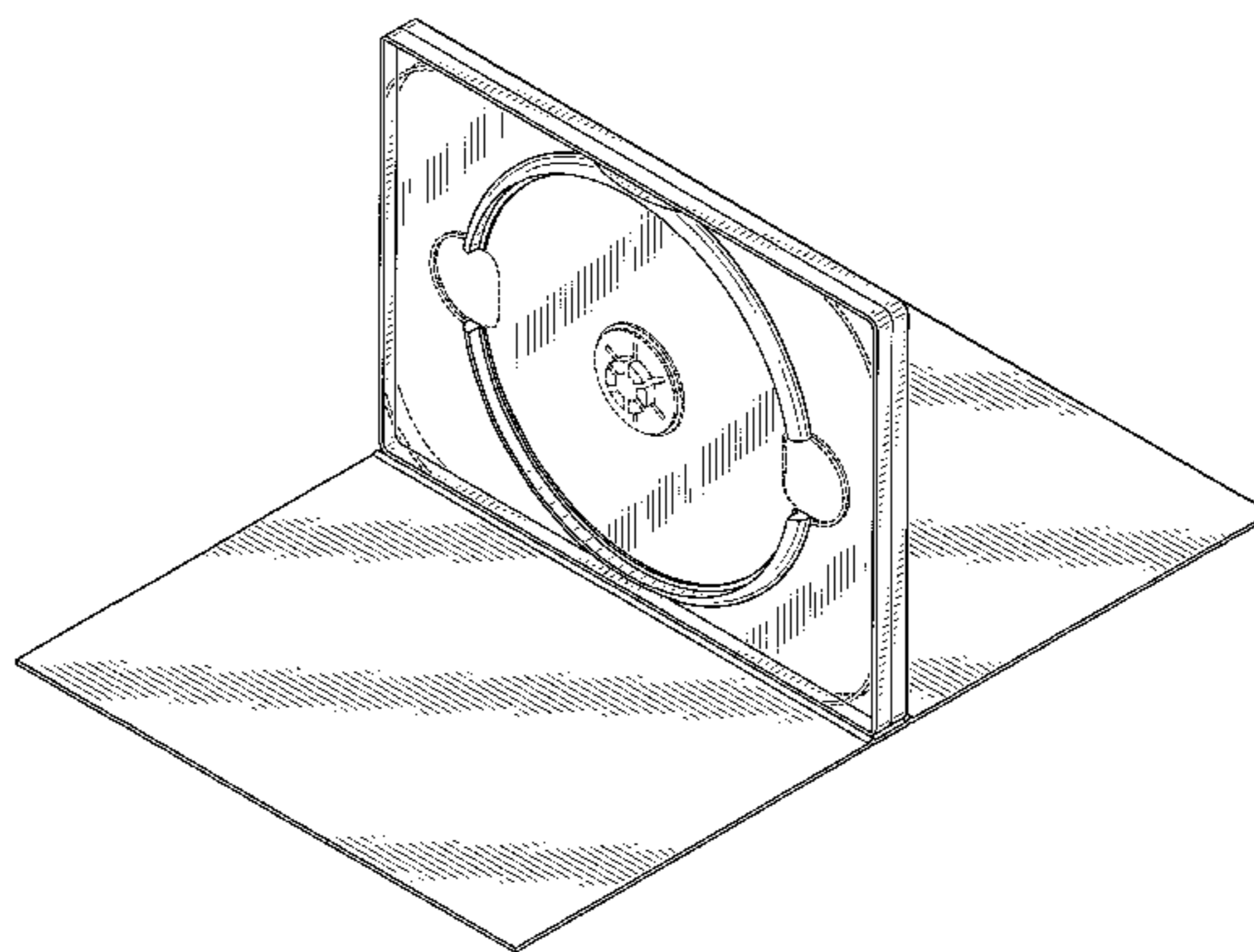

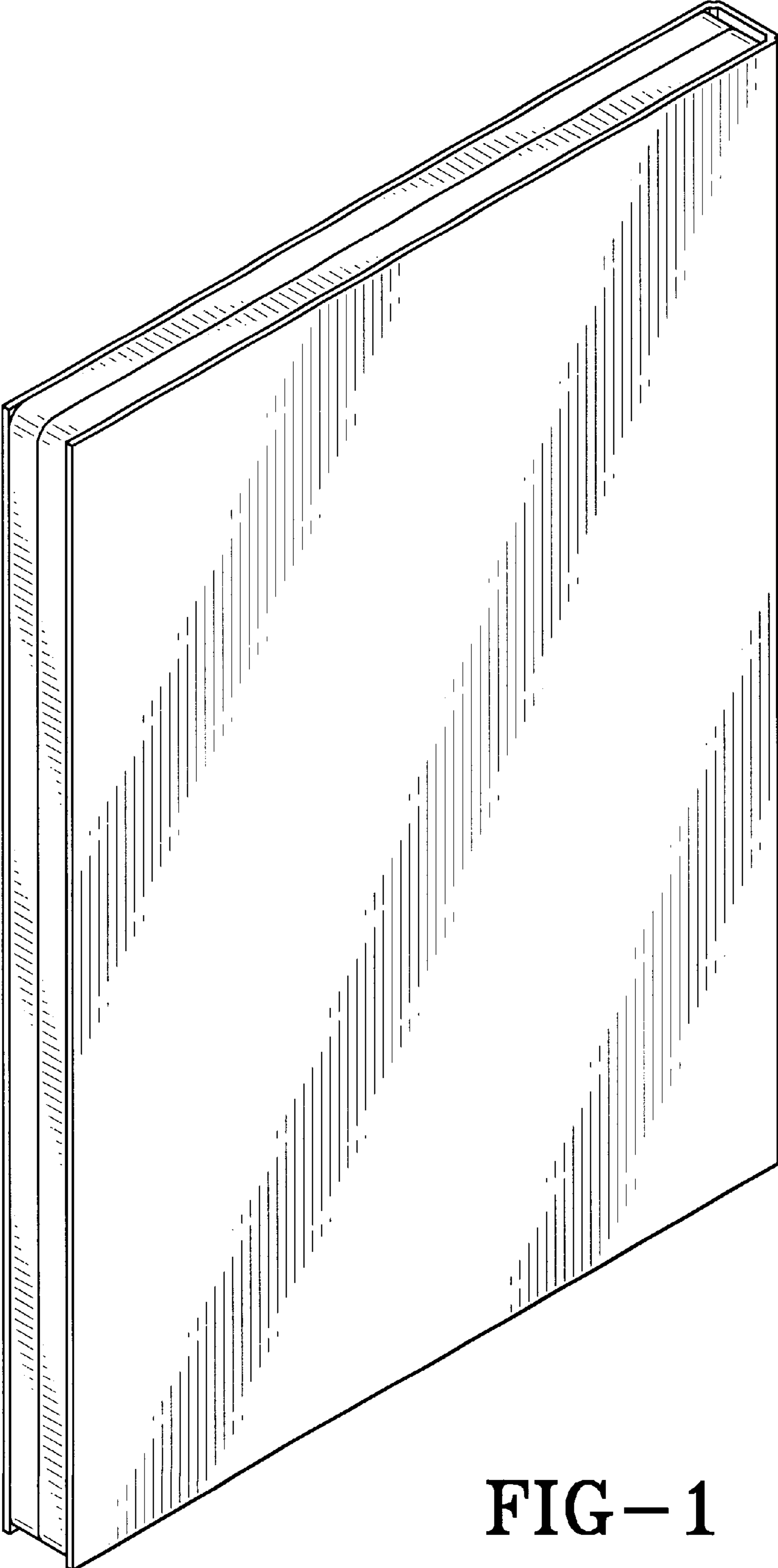

FIG-1

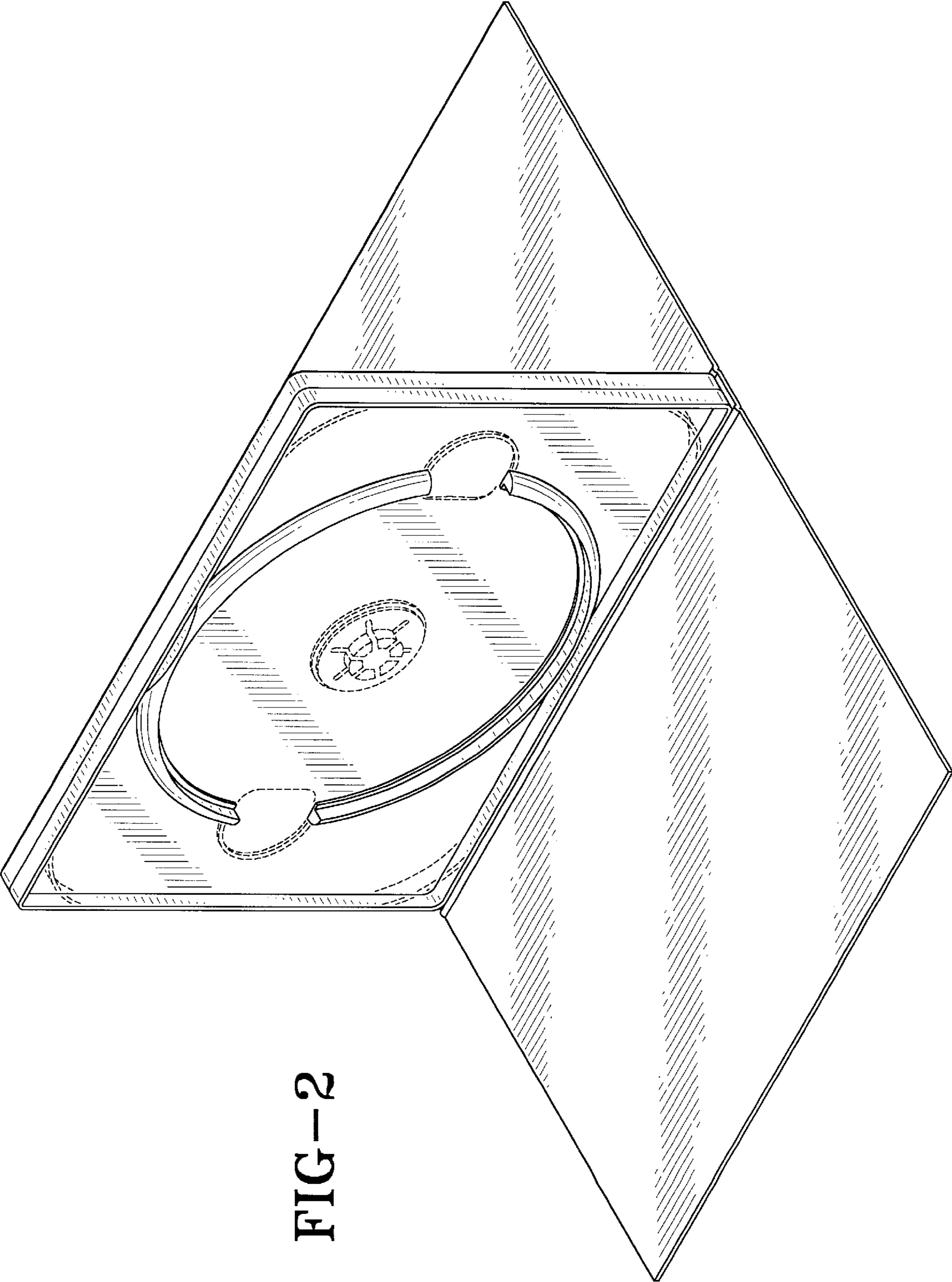

FIG-2

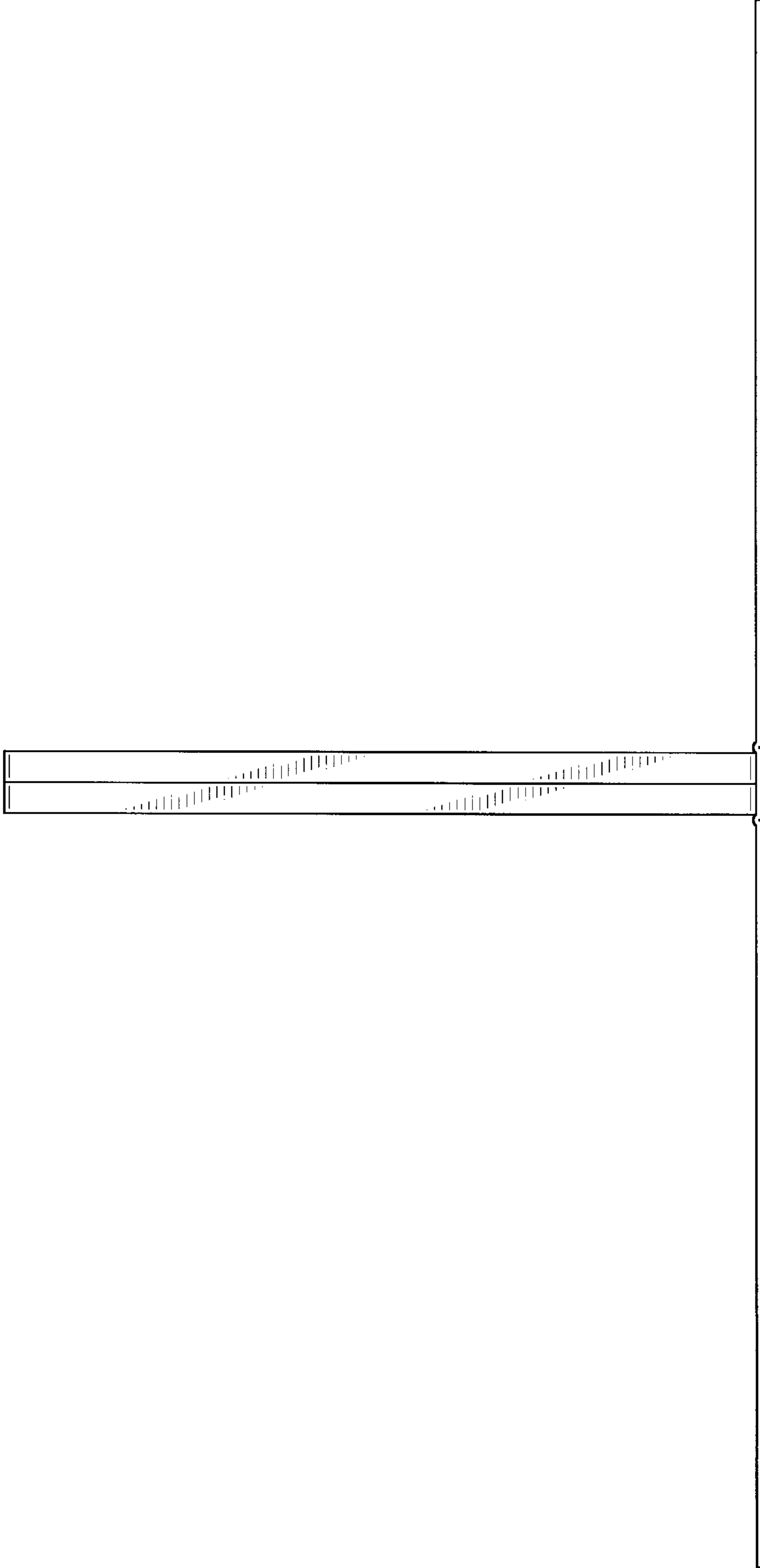

FIG-3

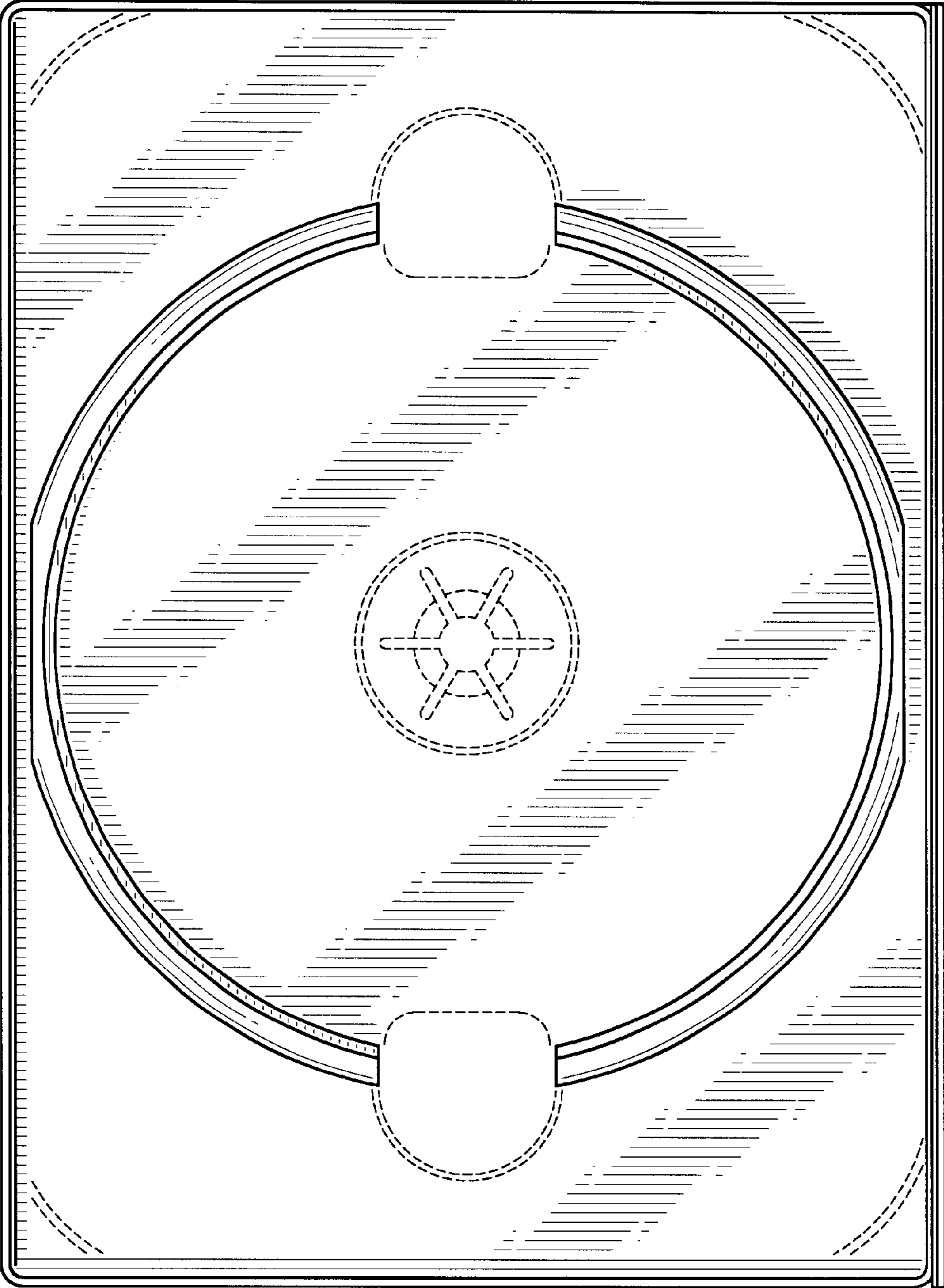

FIG-4

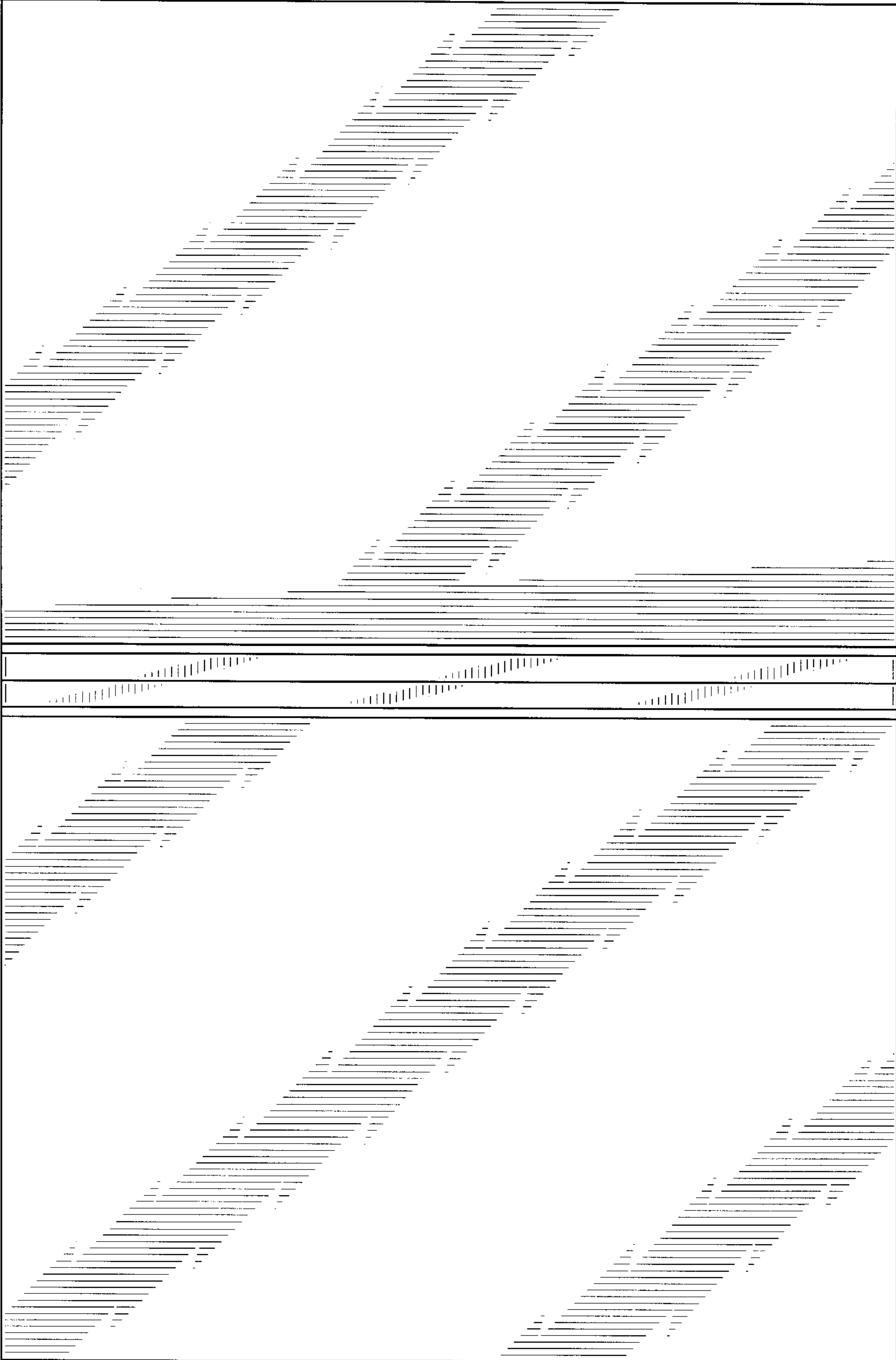

FIG-5

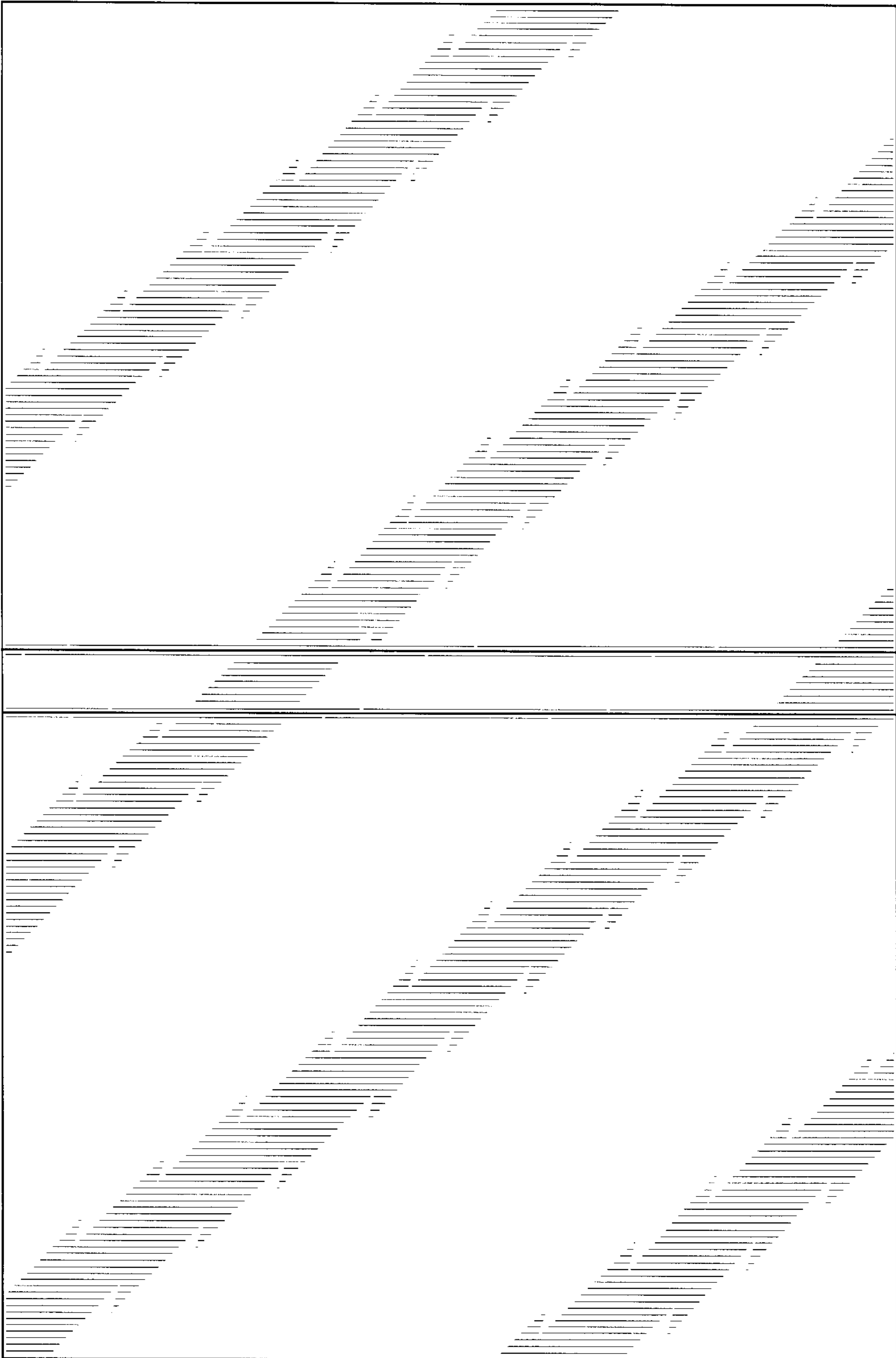

FIG-6