



US00D493909S1

(12) **United States Design Patent**
Sehl

(10) **Patent No.:** **US D493,909 S**
(45) **Date of Patent:** **** Aug. 3, 2004**

(54) **INTERIOR ILLUMINATED LAMP IN THE
SHAPE OF A DOLPHIN WITH GLOBE**

(75) **Inventor:** **Michael Gaffney Sehl**, Rochester, MN
(US)

(73) **Assignee:** **Sehl Productions, Inc.**, St. Paul, MN
(US)

(**) **Term:** **14 Years**

(21) **Appl. No.:** **29/175,154**

(22) **Filed:** **Jan. 31, 2003**

(51) **LOC (7) Cl.** **26-03**

(52) **U.S. Cl.** **D26/98**

(58) **Field of Search** D26/4, 93, 94,
D26/98, 104; 362/124, 410-414, 806, 808,
809; D21/597, 599; 428/16; D11/134, 158;
446/158; D19/97

(56) **References Cited**

U.S. PATENT DOCUMENTS

3,808,734 A * 5/1974 Suzuki 446/158

D261,374 S * 10/1981 Santa-Eulalia Carvajales
et al. D11/158
D441,882 S * 5/2001 Lee D26/4

* cited by examiner

Primary Examiner—Alan P. Douglas

Assistant Examiner—Linda Brooks

(74) *Attorney, Agent, or Firm*—David Johnson

(57) **CLAIM**

The ornamental design for an interior illuminated lamp in the shape of a dolphin with globe, as shown and described.

DESCRIPTION

FIG. 1 is a view in perspective of the present invention; FIG. 2 is a left side view of the present invention; FIG. 3 is a right side view of the present invention; FIG. 4 is a back view of the present invention; FIG. 5 is a front view of the present invention; FIG. 6 is a top view of the present invention; and, FIG. 7 is a bottom view of the present invention.

1 Claim, 2 Drawing Sheets

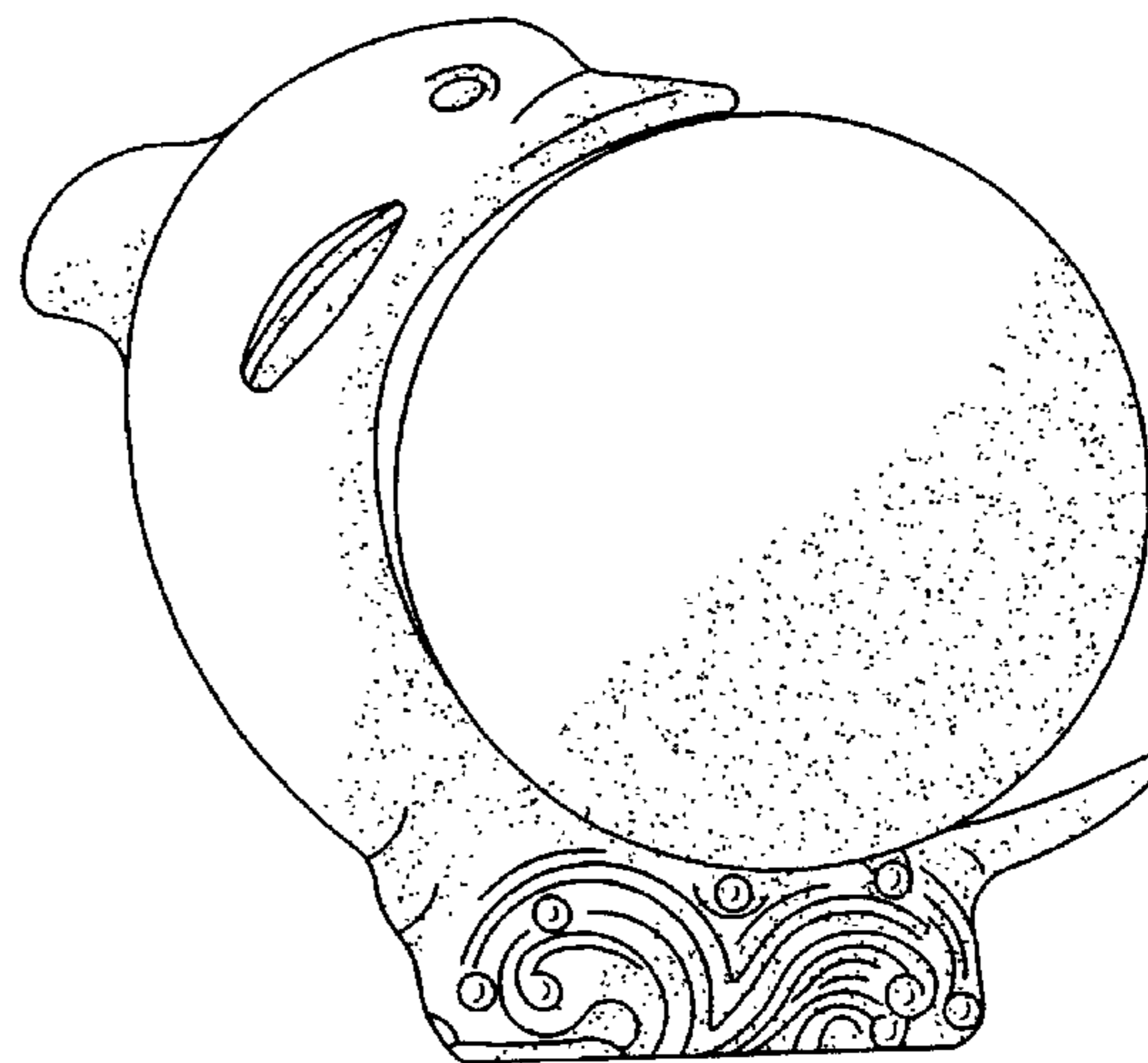
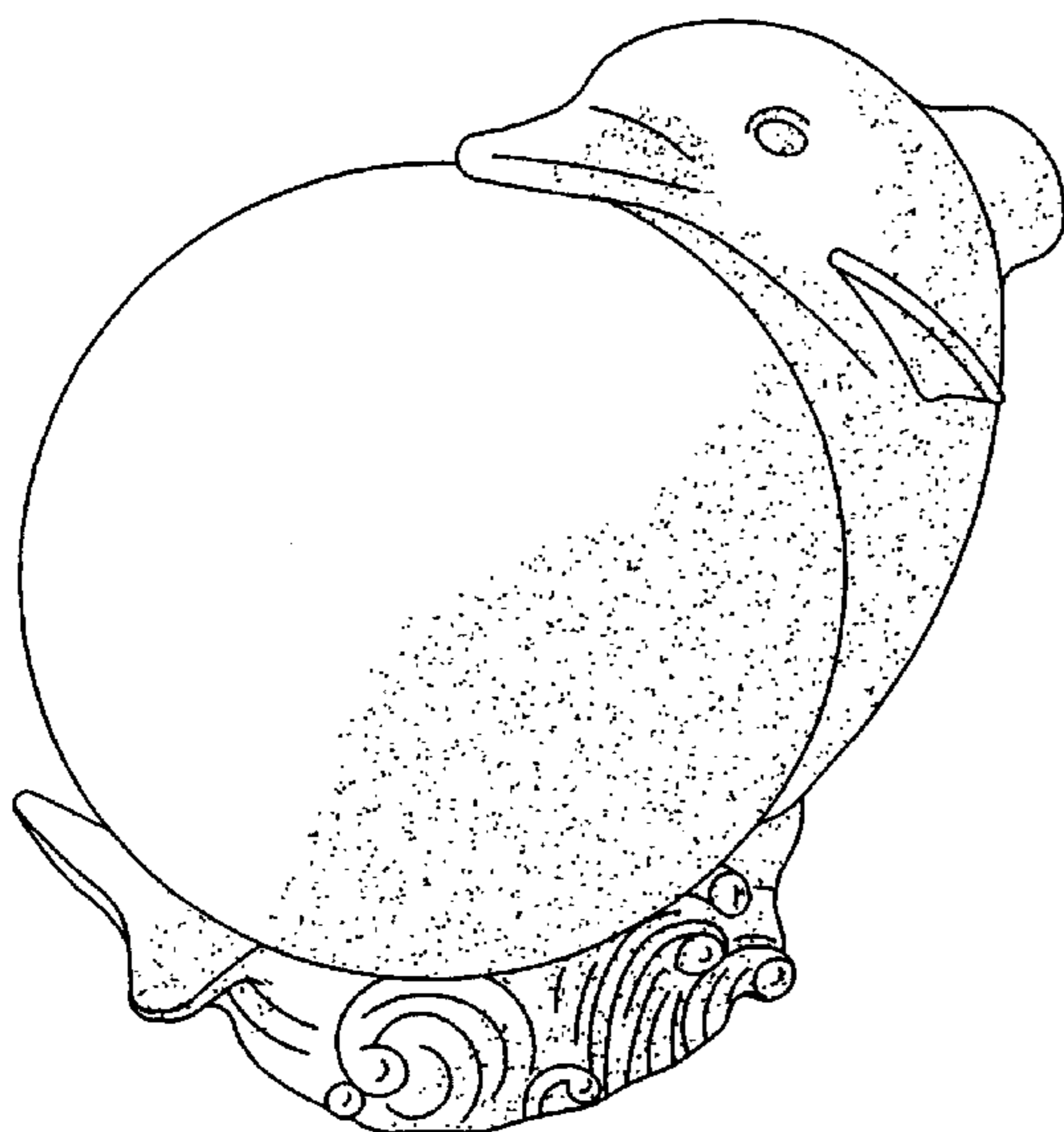

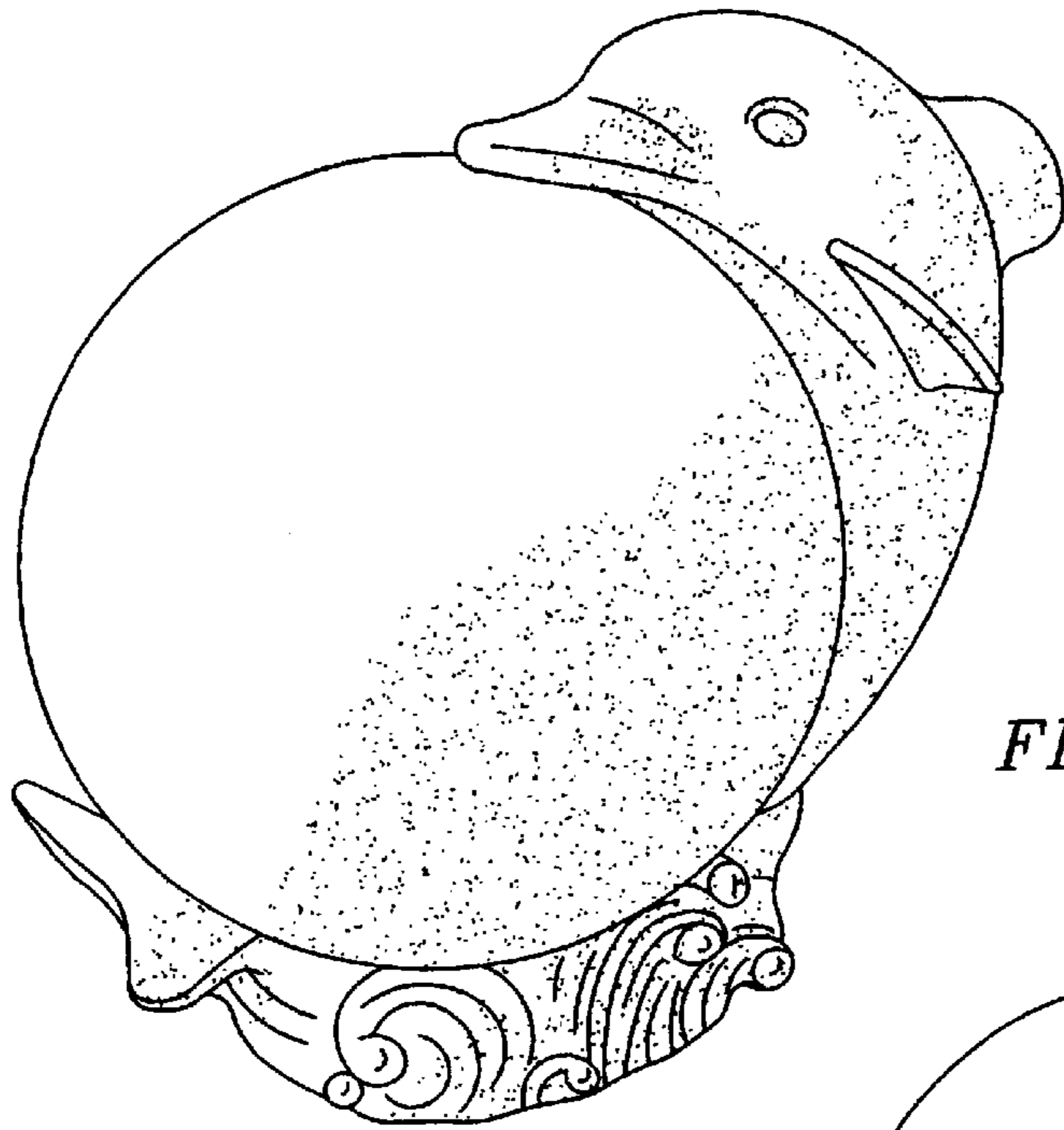

FIG. 1

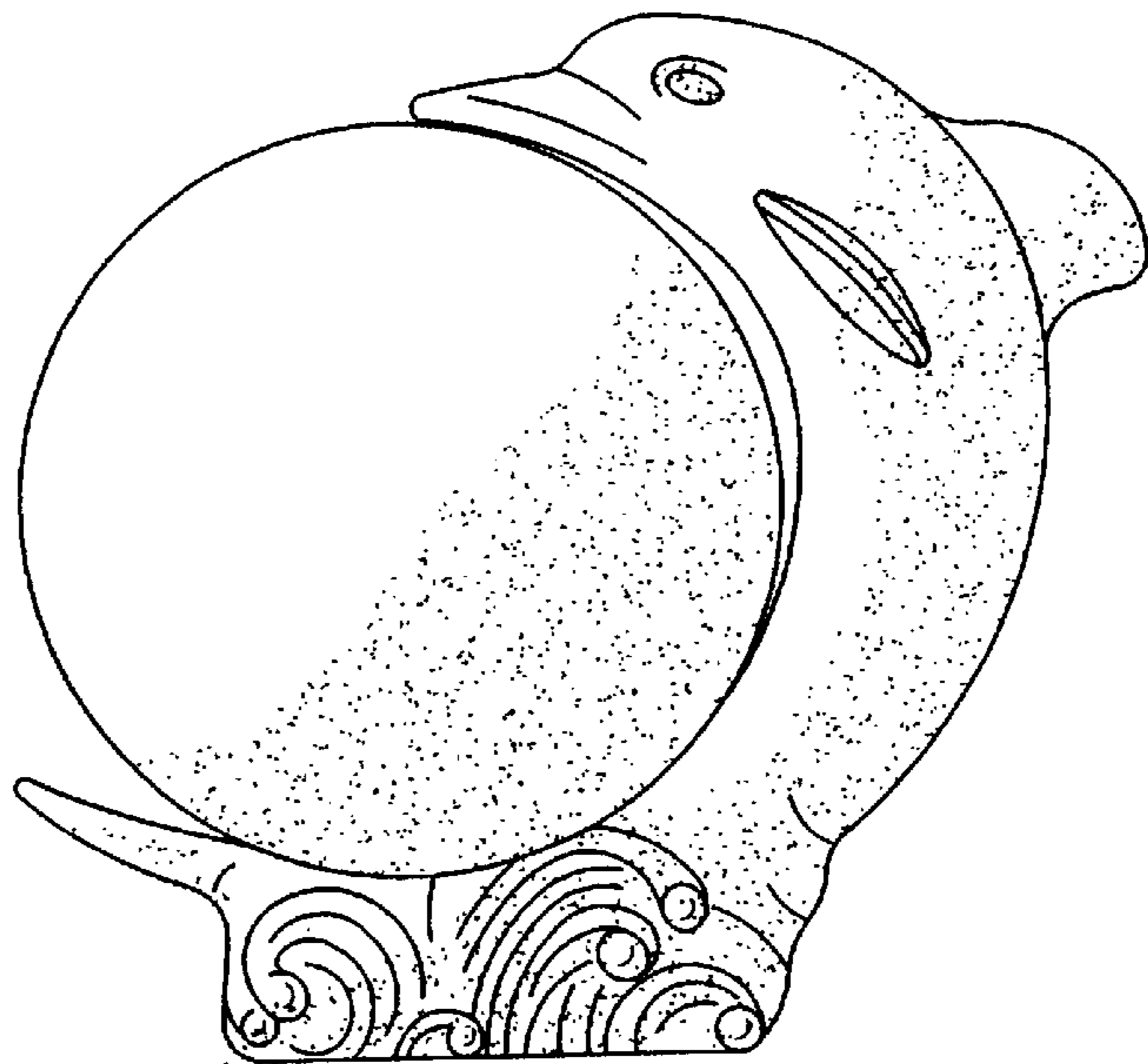

FIG. 2

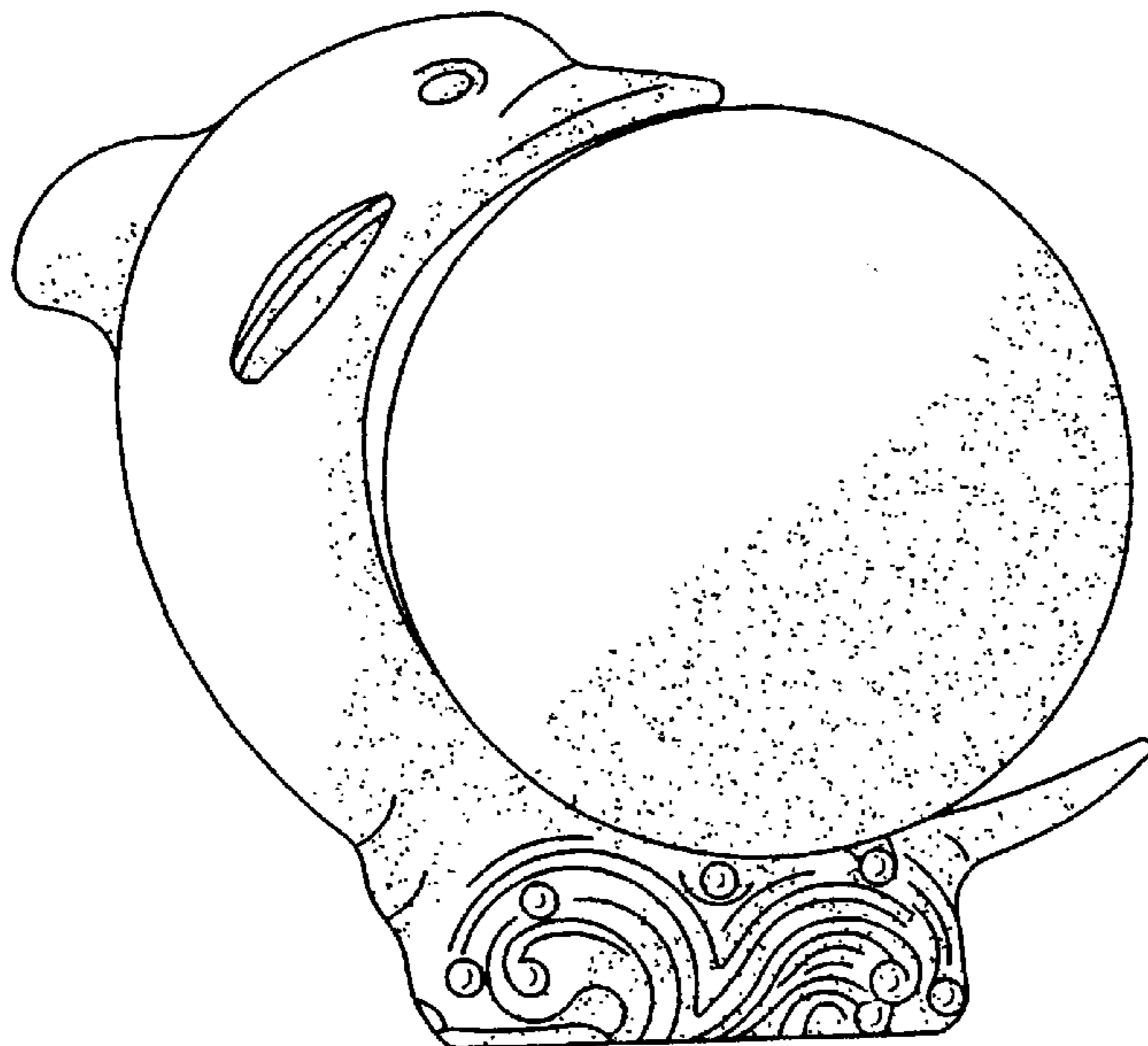

FIG. 3

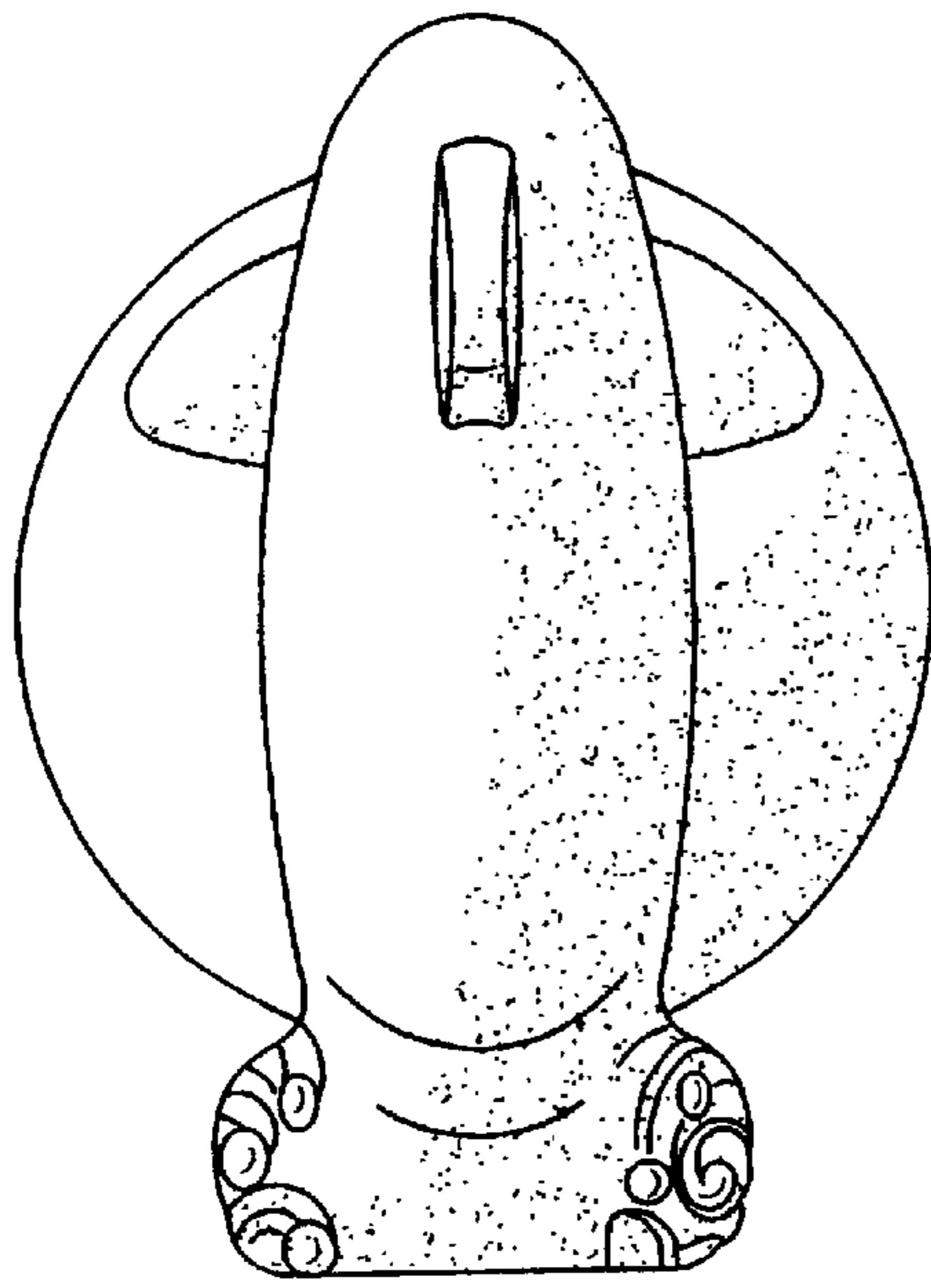

FIG. 4

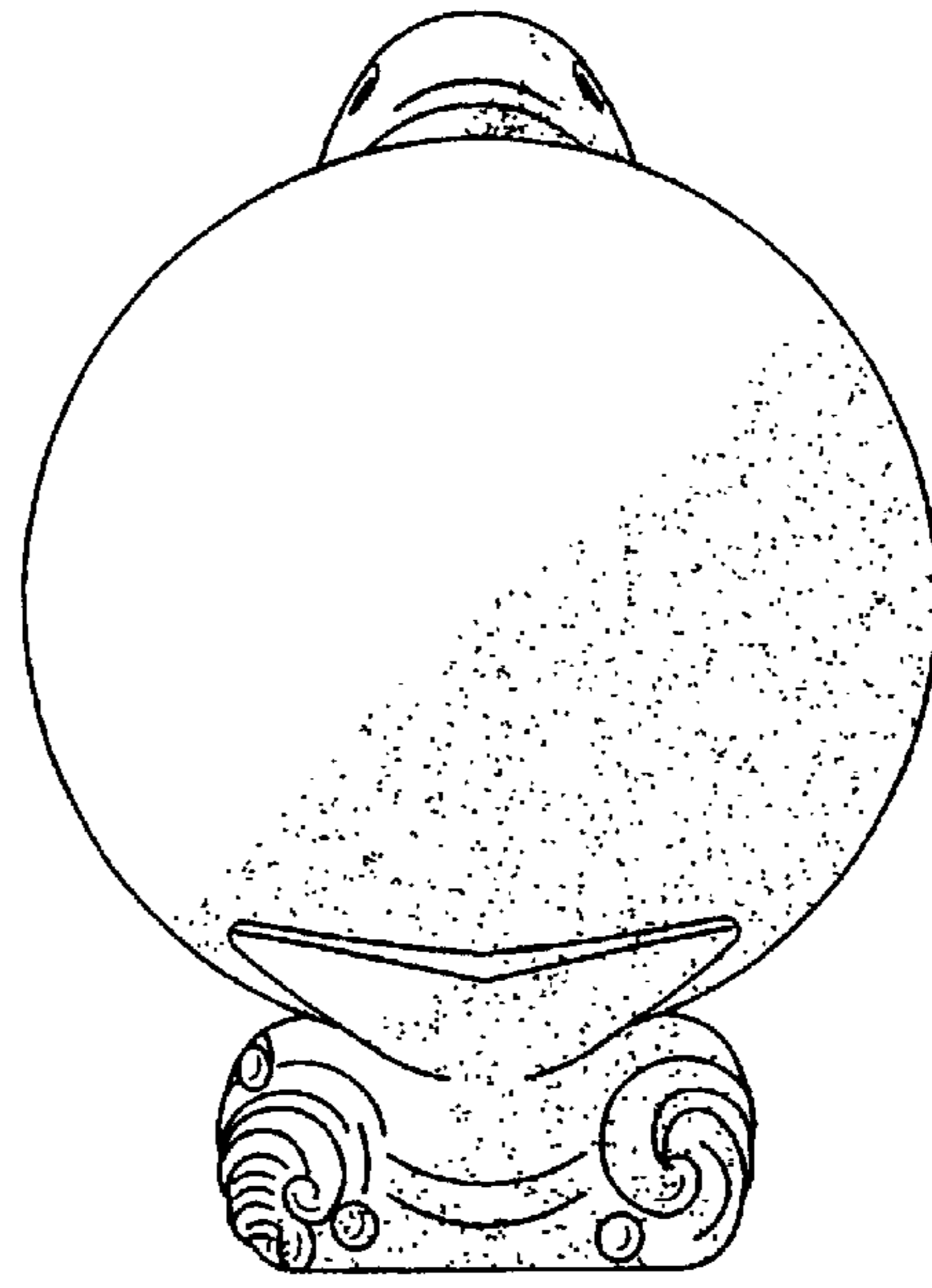

FIG. 5

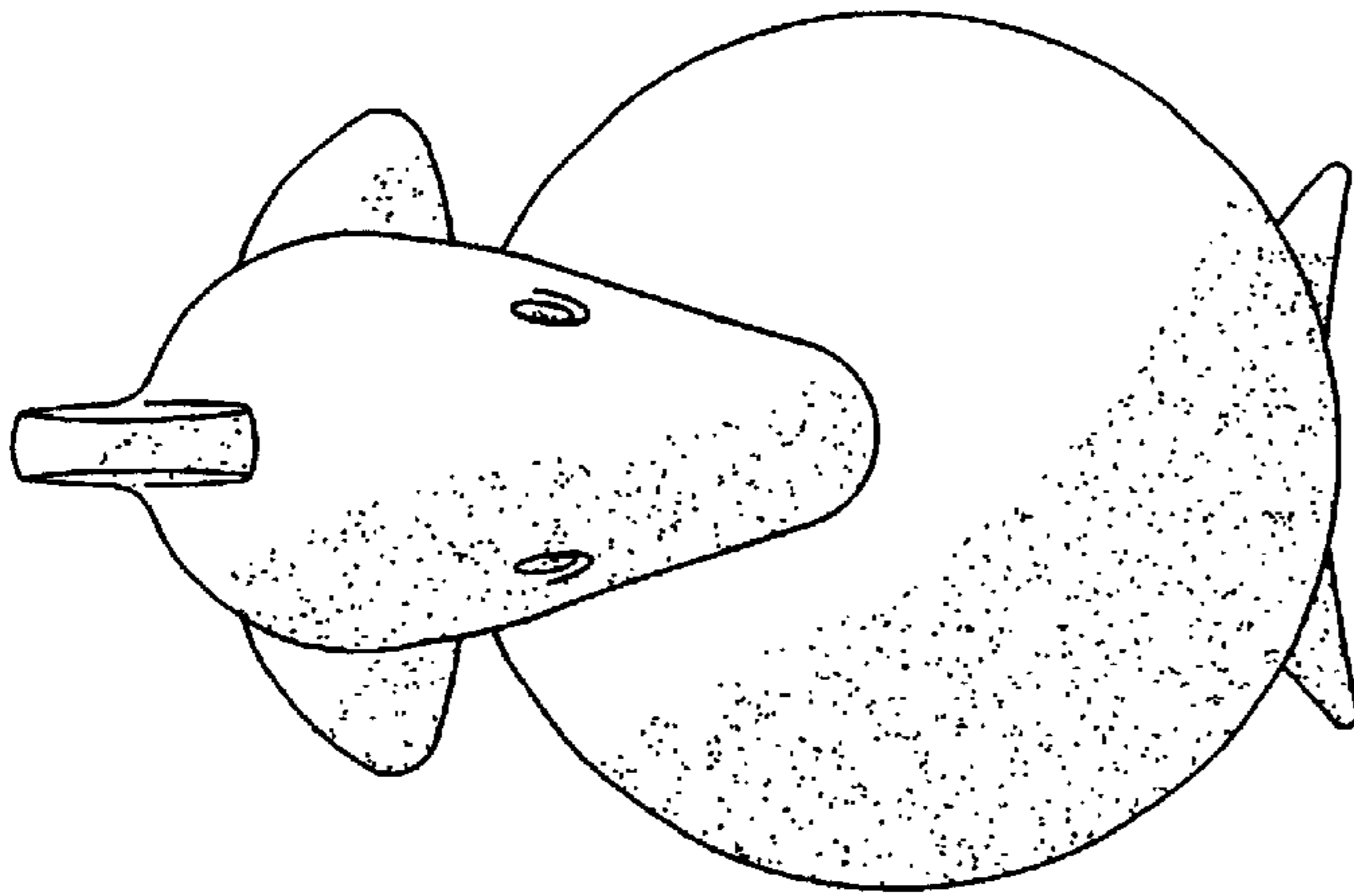

FIG. 6

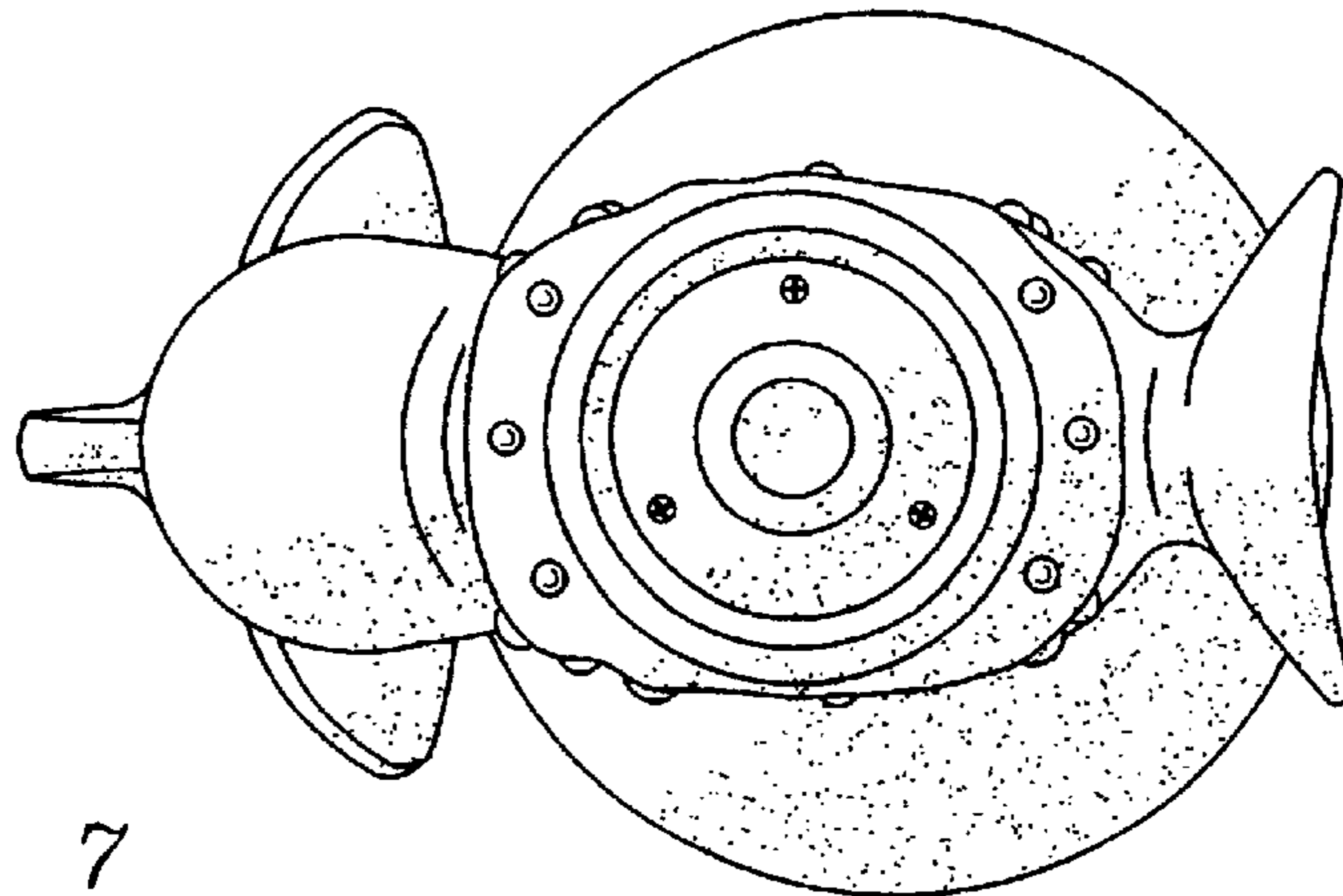

FIG. 7