

US00D493820S1

(12) **United States Design Patent**  
**Matsuo et al.**

(10) **Patent No.:** **US D493,820 S**

(45) **Date of Patent:** **\*\* Aug. 3, 2004**

(54) **INK TANK FOR PRINTER**

(75) Inventors: **Keisuke Matsuo**, Yokohama (JP);  
**Hiroki Hayashi**, Yokohama (JP);  
**Tetsuya Ohashi**, Matsudo (JP); **Kenji**  
**Kitabatake**, Kawasaki (JP); **Yasuo**  
**Kotaki**, Yokohama (JP)

(73) Assignee: **Canon Kabushiki Kaisha**, Tokyo (JP)

(\*\*) Term: **14 Years**

(21) Appl. No.: **29/178,484**

(22) Filed: **Mar. 28, 2003**

(30) **Foreign Application Priority Data**

Sep. 30, 2002 (JP) ..... 2002-026667

(51) **LOC (7) Cl.** ..... **18-02**

(52) **U.S. Cl.** ..... **D18/56; 347/86**

(58) **Field of Search** ..... **D18/40, 43, 56;**  
**347/86, 87**

(56) **References Cited**

**U.S. PATENT DOCUMENTS**

D427,236 S \* 6/2000 Shinada et al. .... D18/56

D430,601 S 9/2000 Kotaki et al. .... D18/56

D436,990 S 1/2001 Kotaki et al. .... D18/56  
D440,599 S 4/2001 Kotaki et al. .... D18/56  
D441,786 S 5/2001 Kotaki et al. .... D18/56  
D449,643 S \* 10/2001 Hatasa et al. .... D18/56  
D469,463 S \* 1/2003 Yu et al. .... D18/56  
6,595,711 B2 \* 7/2003 Hill ..... 347/86

\* cited by examiner

*Primary Examiner*—Cathy Anne MacCormac

(74) *Attorney, Agent, or Firm*—Fitzpatrick, Cella, Harper & Scinto

(57) **CLAIM**

The ornamental design for an ink tank for printer, as shown and described.

**DESCRIPTION**

FIG. 1 is a front view of an ink tank for printer showing our new design;

FIG. 2 is a rear view thereof;

FIG. 3 is a top plan view thereof;

FIG. 4 is a bottom plan view thereof;

FIG. 5 is a left side view thereof;

FIG. 6 is a right side view thereof; and,

FIG. 7 is a perspective view thereof.

**1 Claim, 4 Drawing Sheets**

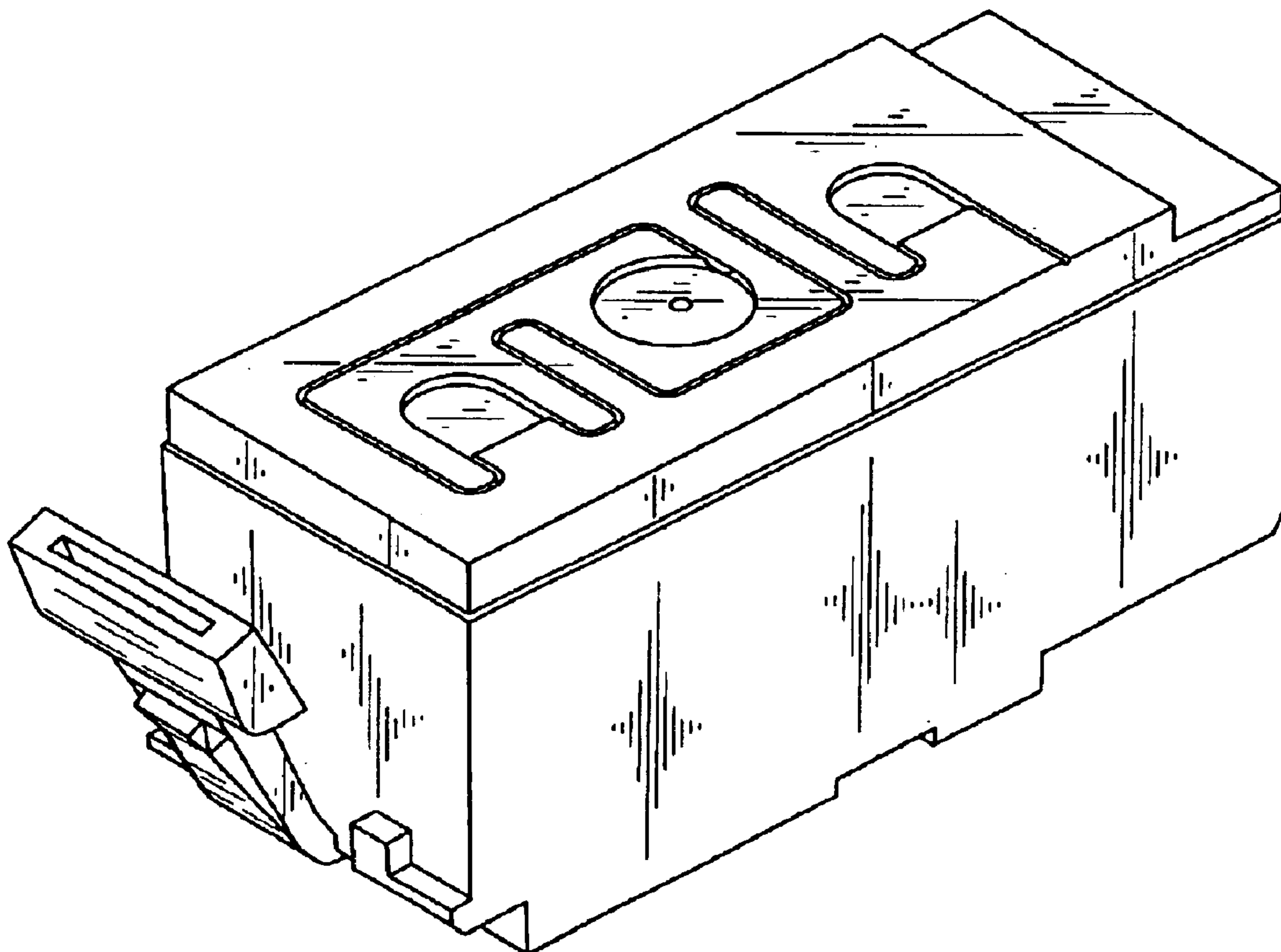

**FIG. 1**

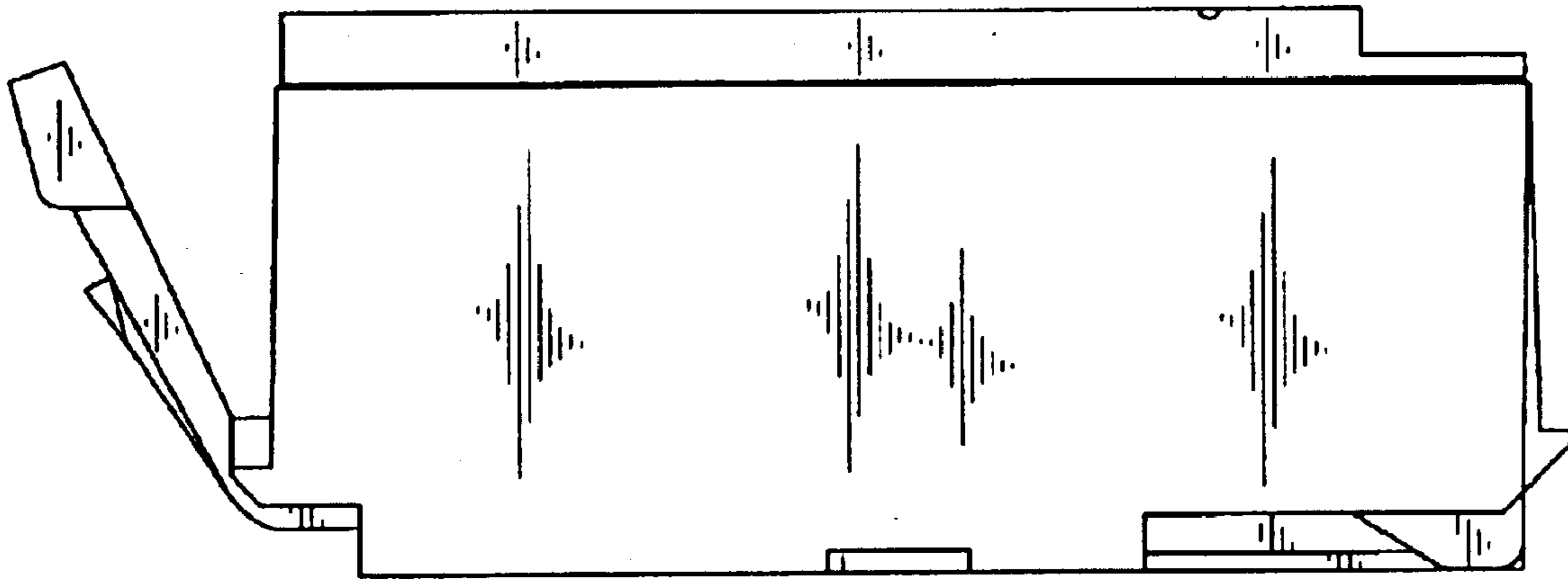

**FIG. 2**

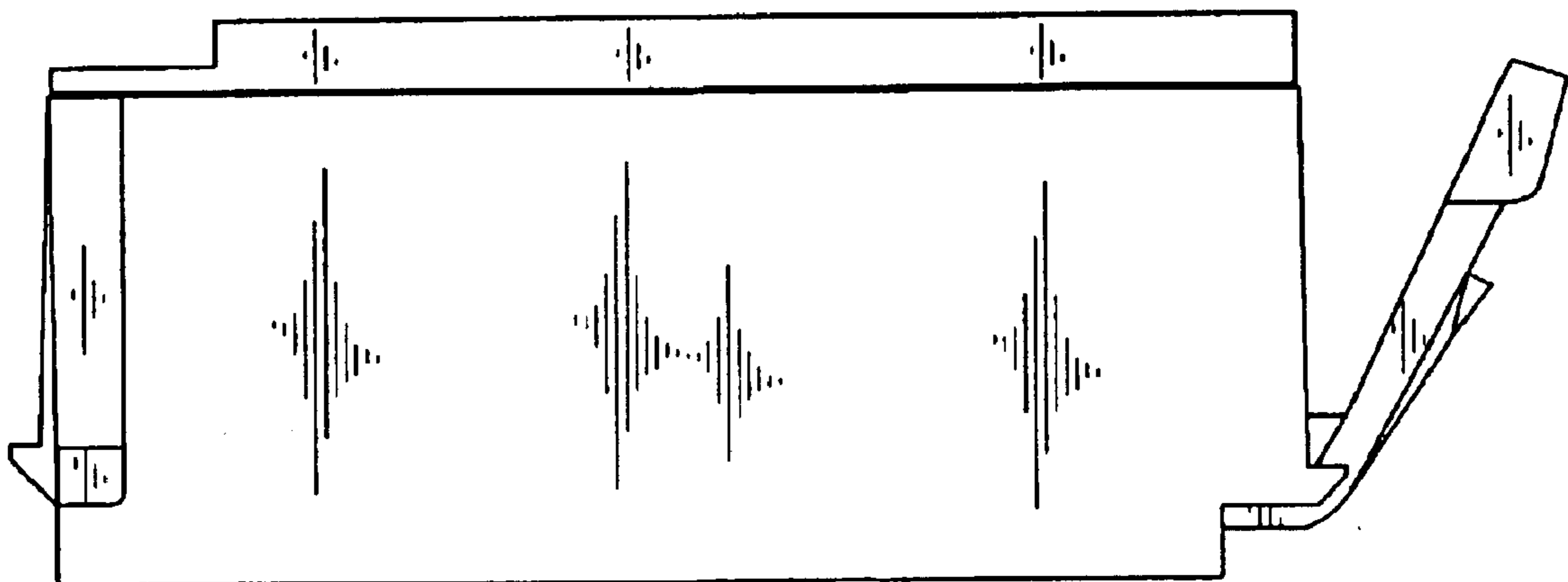

*FIG. 3*

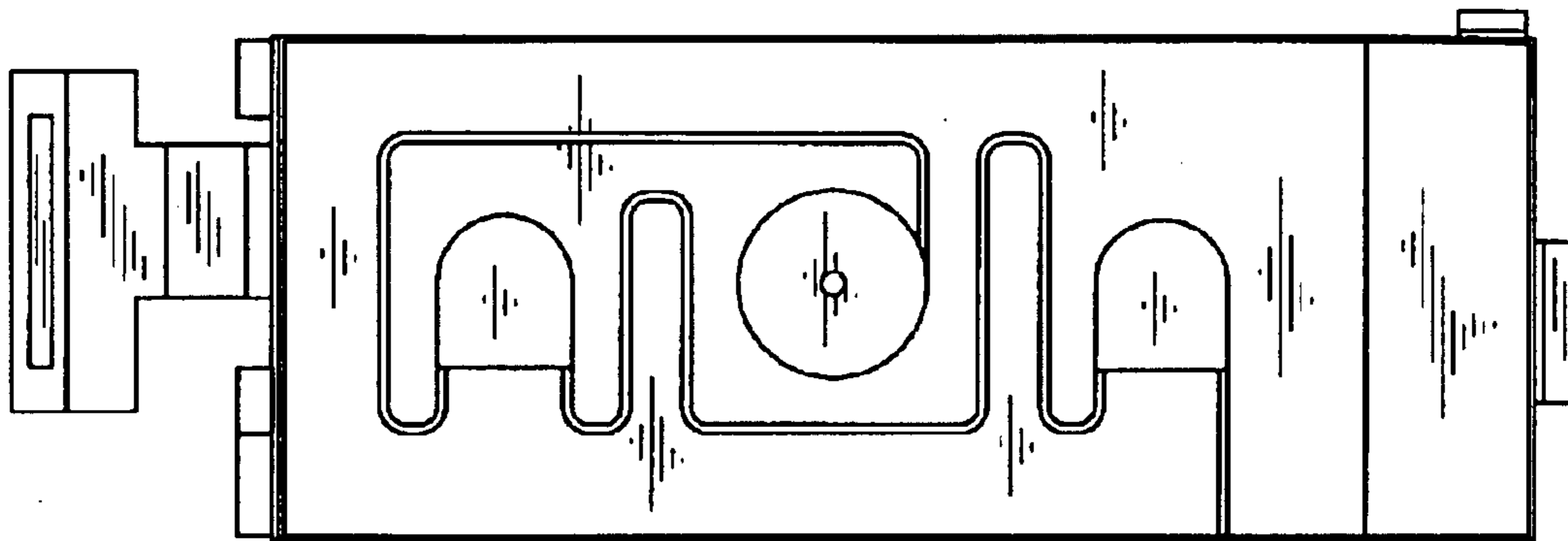

*FIG. 4*

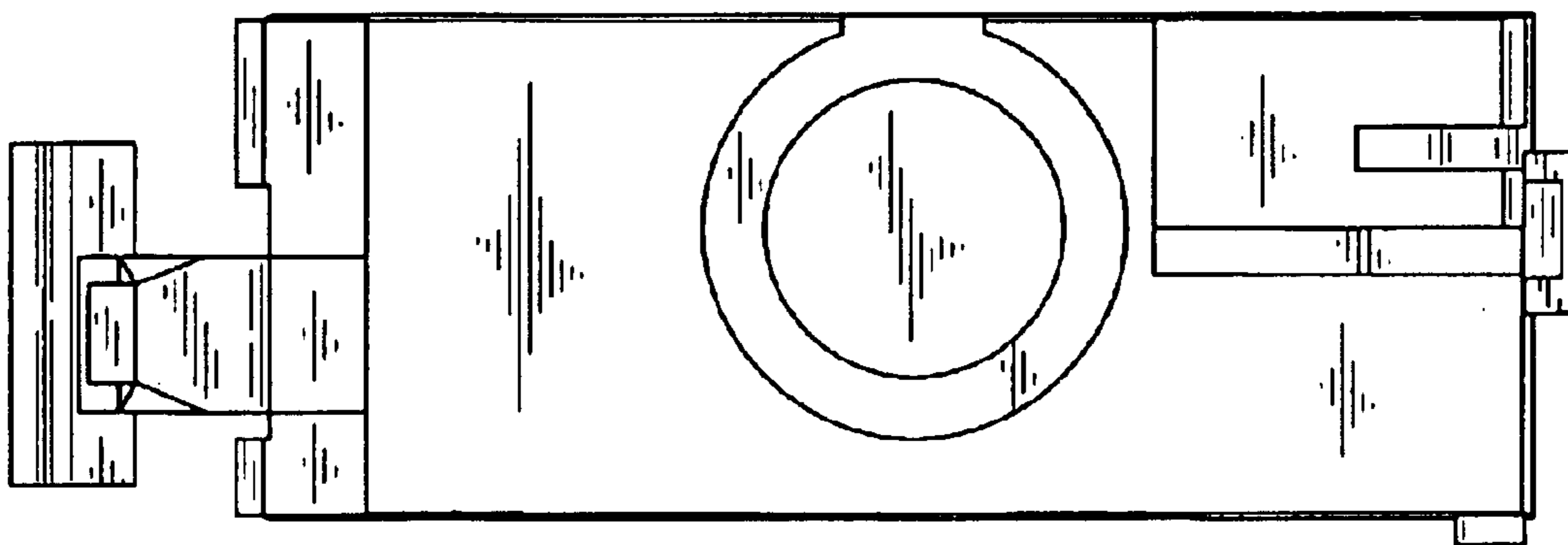

**FIG. 5**

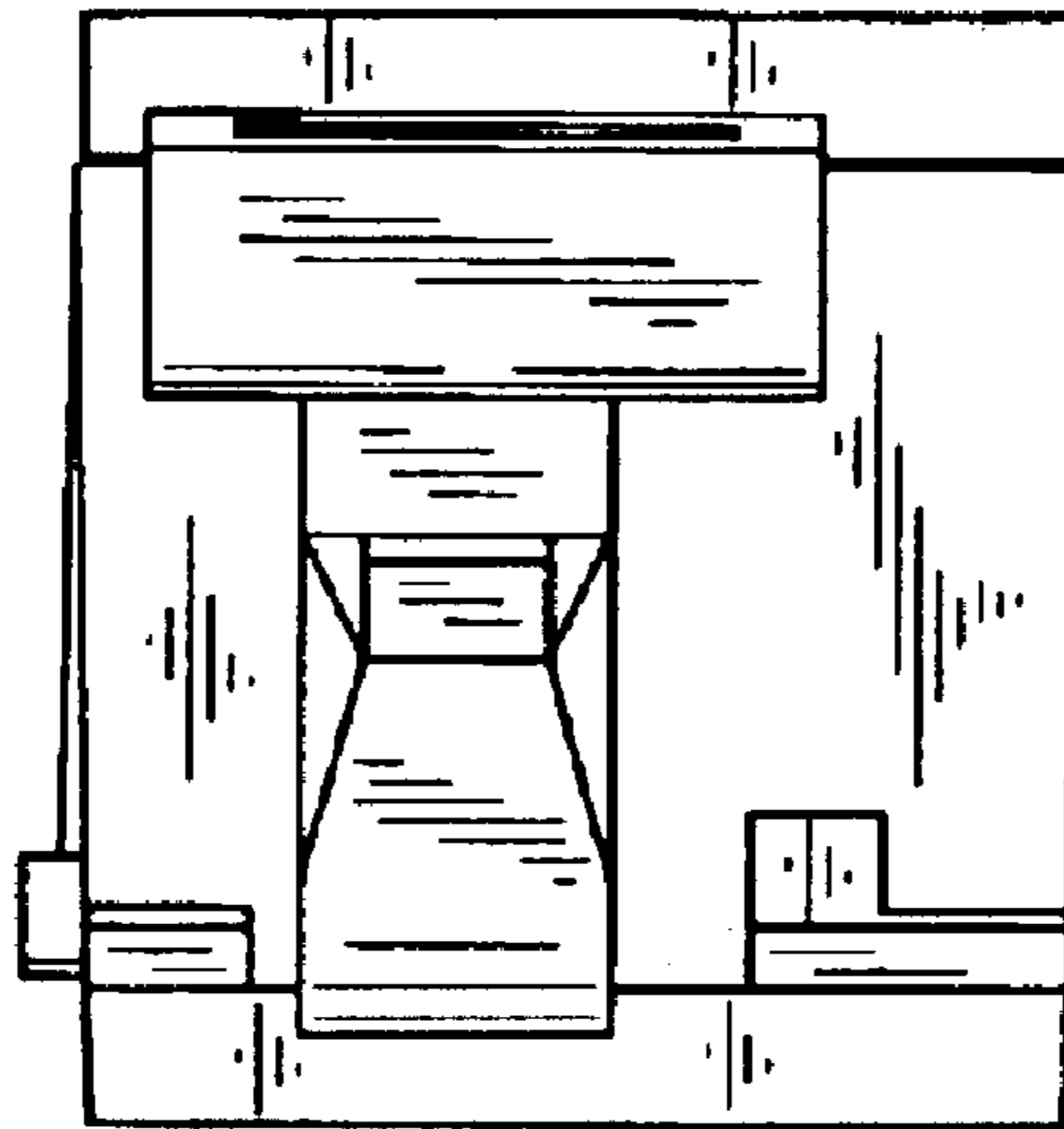

**FIG. 6**

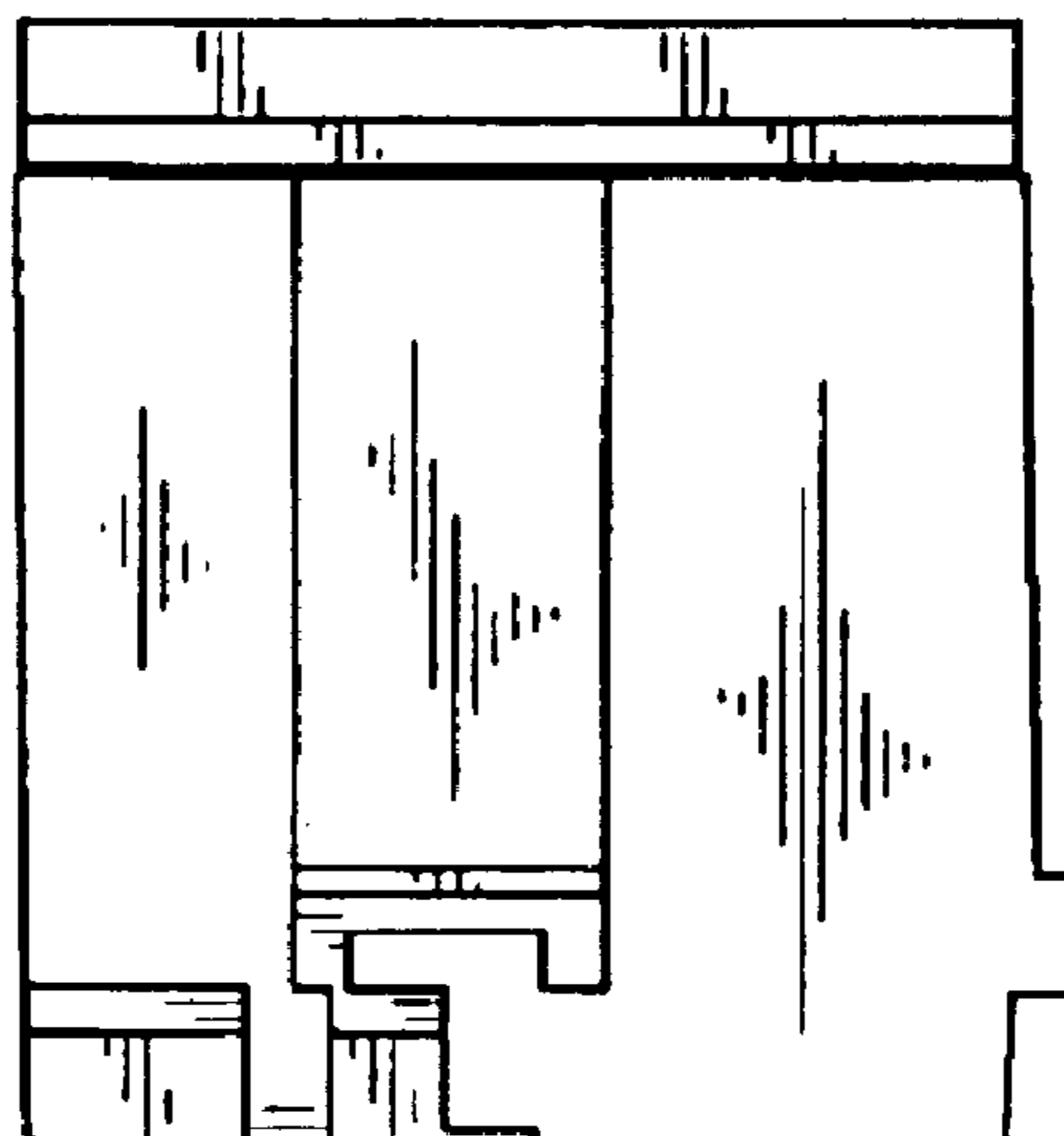

*FIG. 7*

