

US00D493784S1

(12) **United States Design Patent**
Chen

(10) **Patent No.:** **US D493,784 S**

(45) **Date of Patent:** **** Aug. 3, 2004**

(54) **PERSONAL COMPUTER**

D380,200 S * 6/1997 Hill et al. D14/313
D419,971 S * 2/2000 Ito et al. D14/356

(75) Inventor: **Hun-Jen Chen**, San-Chong (TW)

* cited by examiner

(73) Assignee: **Micro-Star Intl Co., Ltd.**, Chung-Ho (TW)

Primary Examiner—Freda S. Nunn
(74) *Attorney, Agent, or Firm*—Winston Hsu

(**) Term: **14 Years**

(57) **CLAIM**

(21) Appl. No.: **29/192,838**

The ornamental design for a personal computer, as shown and described.

(22) Filed: **Oct. 31, 2003**

(30) **Foreign Application Priority Data**

DESCRIPTION

Jun. 24, 2003 (TW) 92303896

FIG. 1 is a front elevational view of a personal computer showing our new design;
FIG. 2 is a left side elevational view thereof;
FIG. 3 is a right side elevational view thereof;
FIG. 4 is a rear elevational view thereof;
FIG. 5 is a top plan view thereof;
FIG. 6 is a bottom plan view thereof; and,
FIG. 7 is a perspective view thereof.

(51) **LOC (7) Cl.** **14-02**

(52) **U.S. Cl.** **D14/314**

(58) **Field of Search** D14/301, 302,
D14/308, 311, 313, 314, 356; D13/162,
184, 199; 360/99.01-99.12; 361/690-696;
369/34.01, 36.01

(56) **References Cited**

U.S. PATENT DOCUMENTS

D224,020 S * 6/1972 Miska D14/313

1 Claim, 7 Drawing Sheets

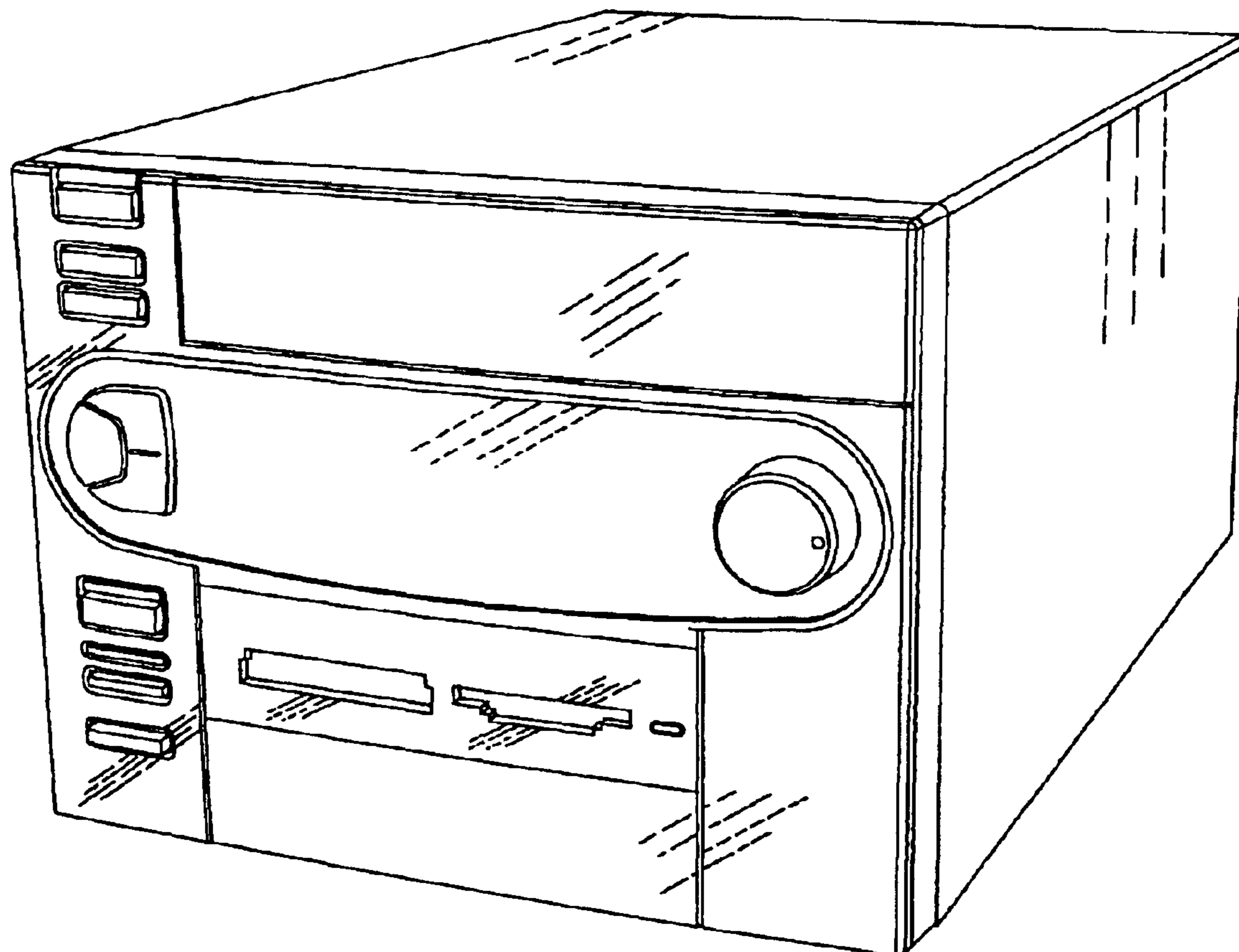

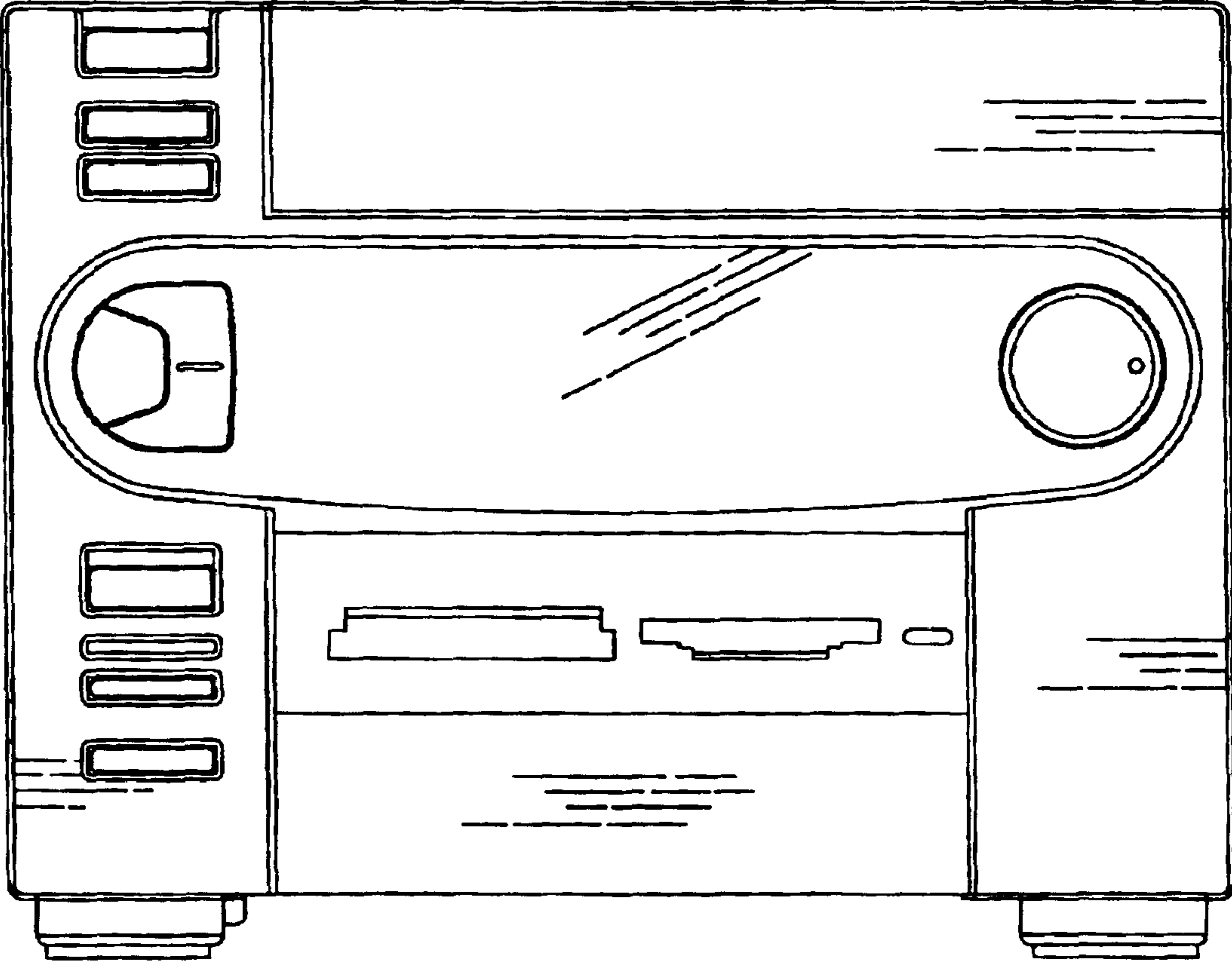

Fig. 1

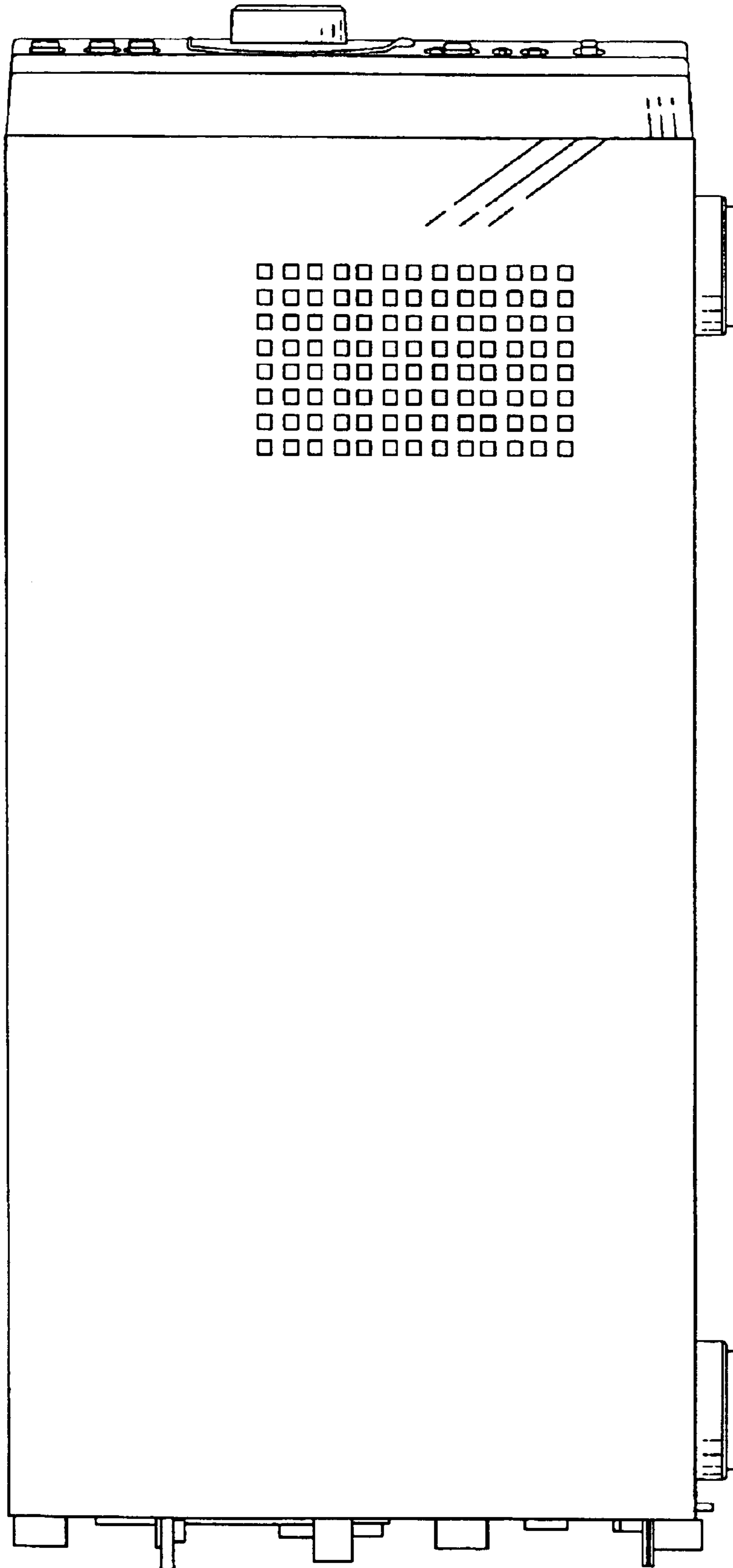

Fig. 2

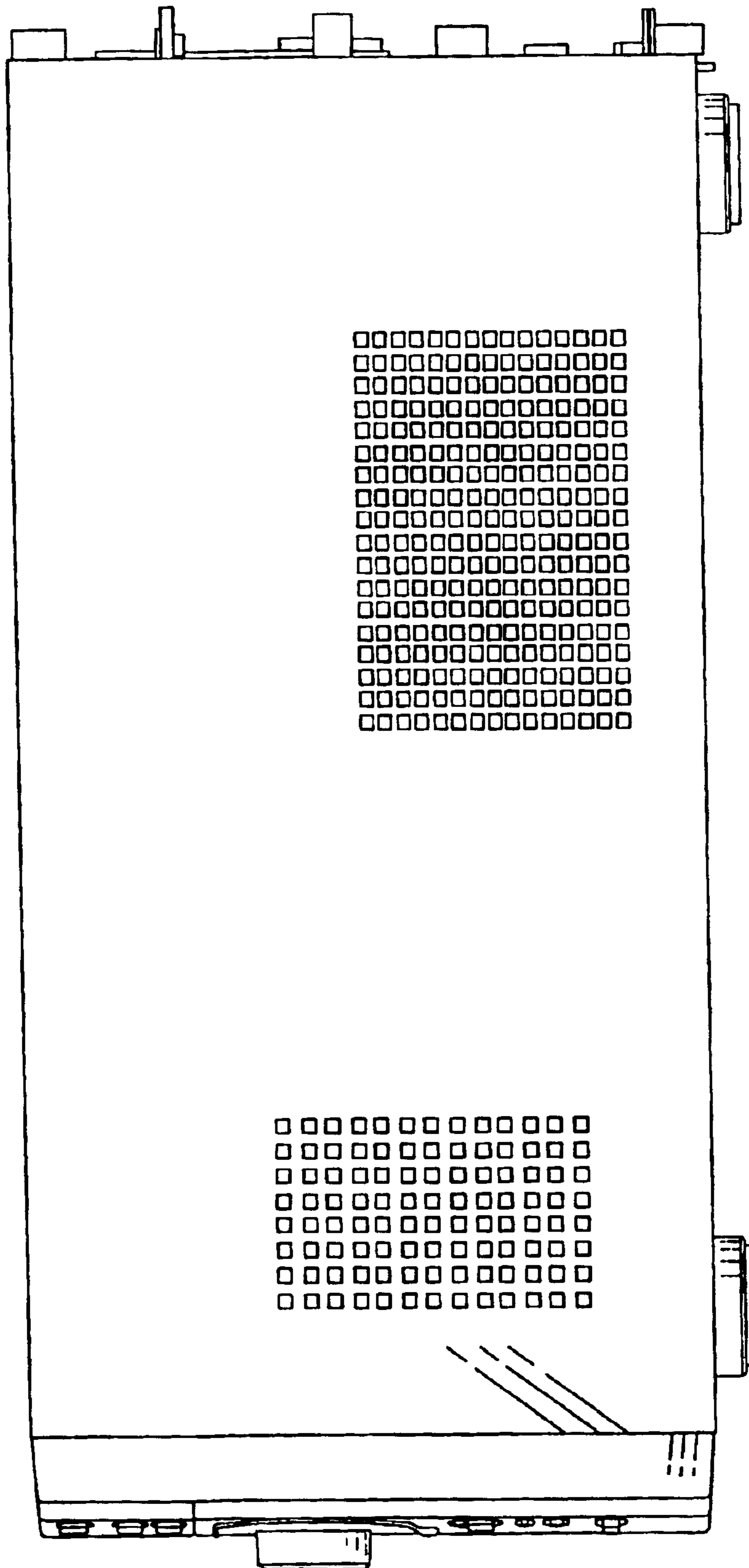

Fig. 3

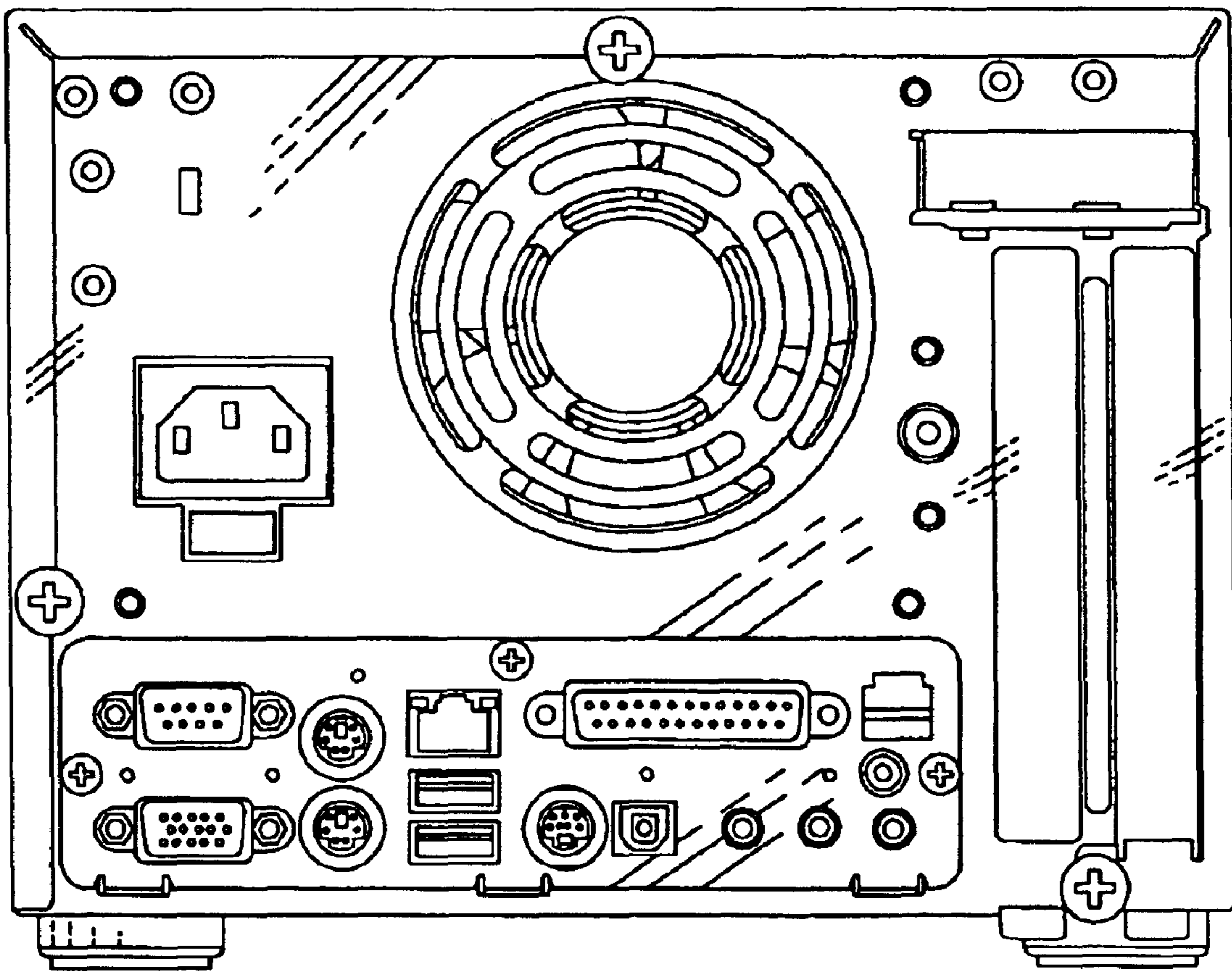

Fig. 4

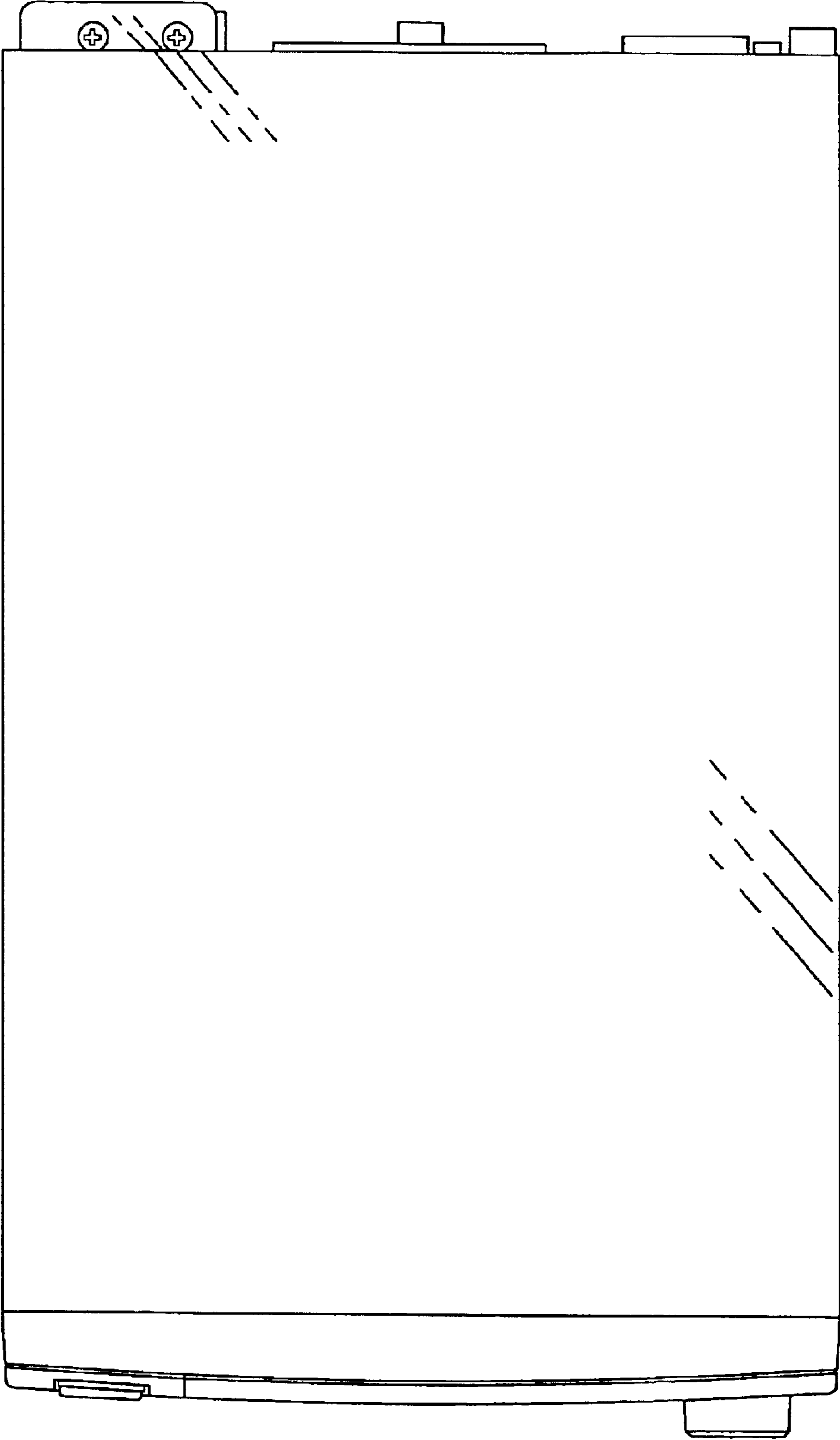

Fig. 5

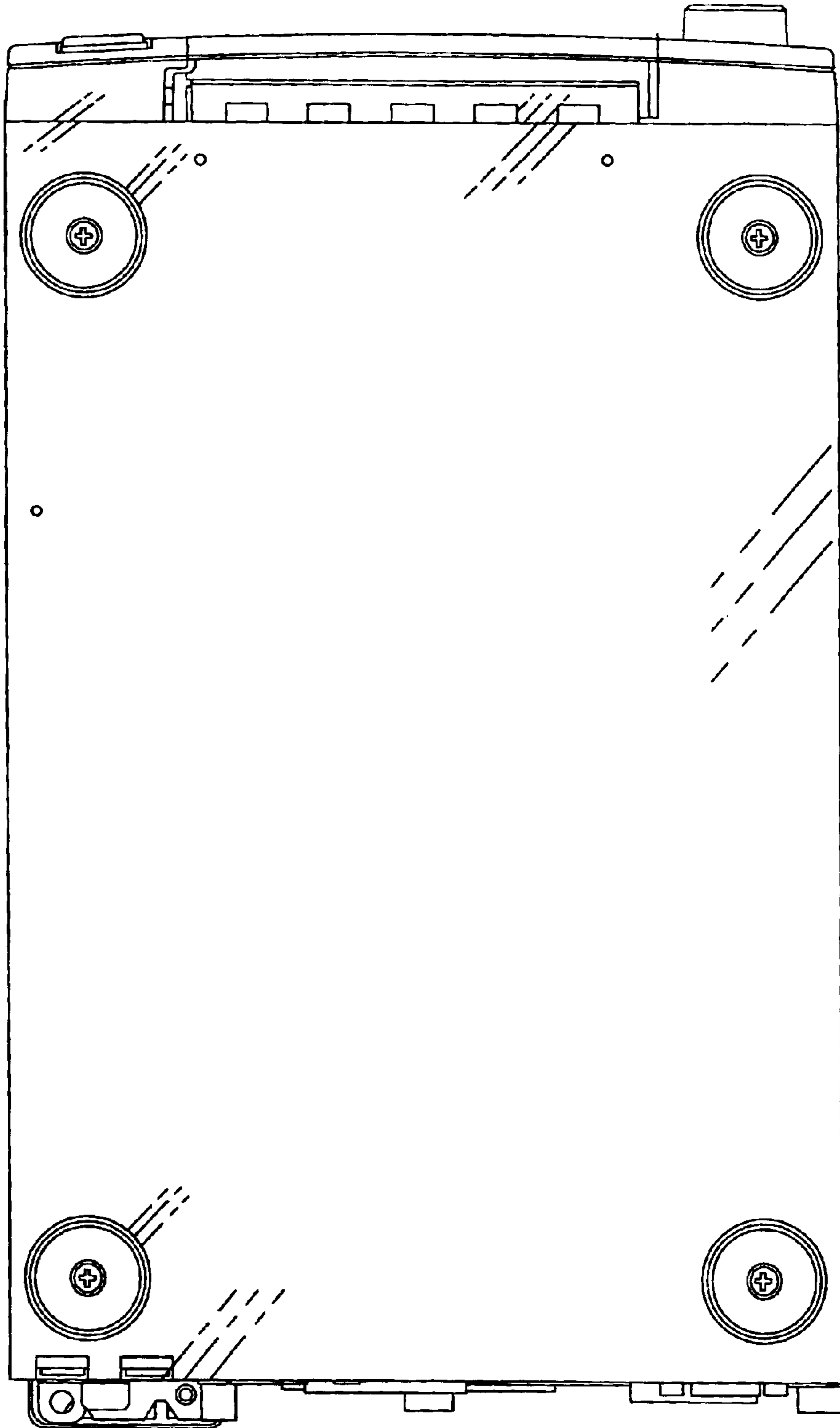

Fig. 6

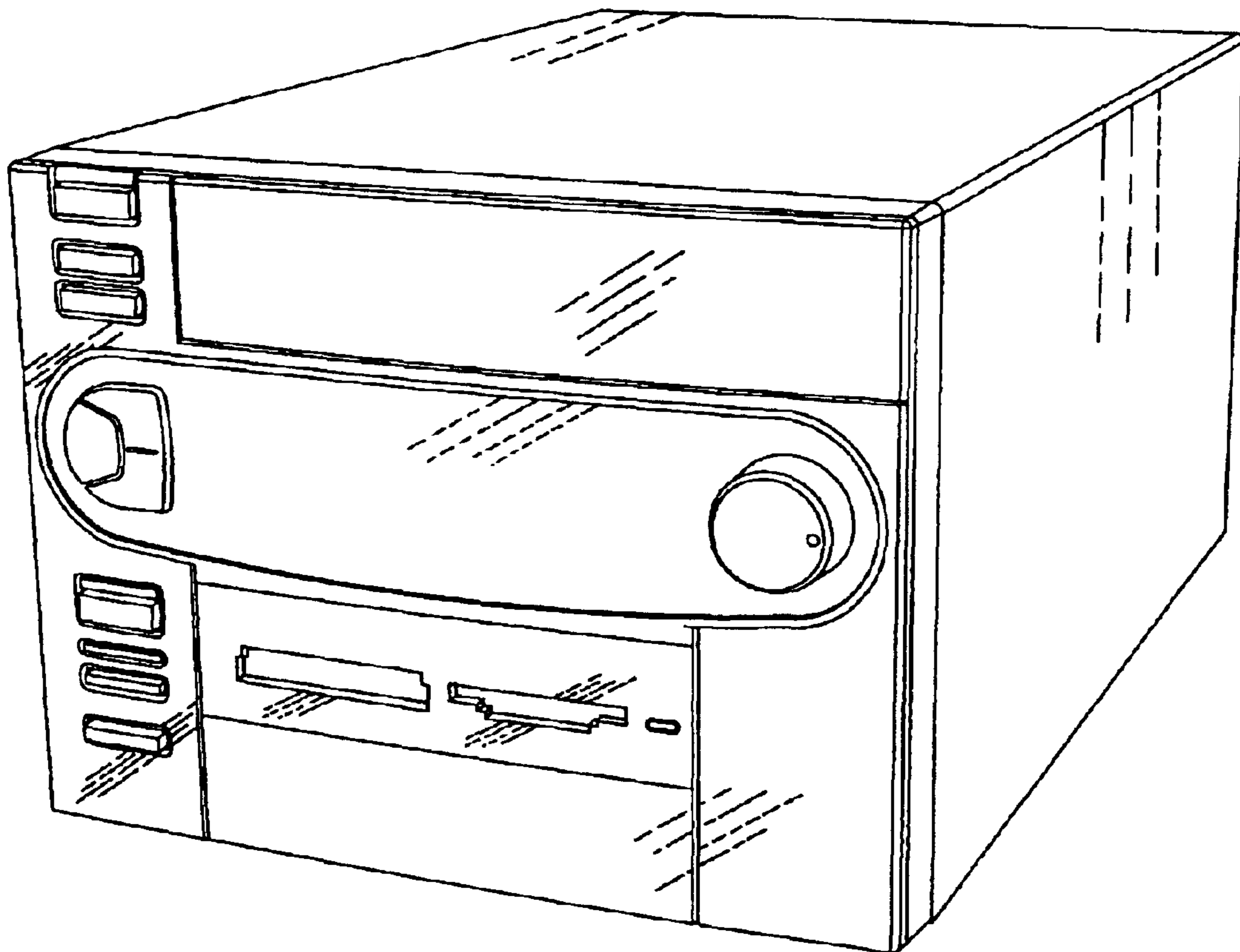

Fig. 7