

US00D493596S1

(12) **United States Design Patent**
Mori

(10) **Patent No.:** **US D493,596 S**
(45) **Date of Patent:** **** Jul. 27, 2004**

(54) **FORKLIFT TRUCK**

(75) **Inventor:** **Hiroki Mori, Kariya (JP)**

(73) **Assignee:** **Kabushiki Kaisha Toyota Jidoshokki, Kariya (JP)**

(**) **Term:** **14 Years**

(21) **Appl. No.:** **29/186,627**

(22) **Filed:** **Jul. 17, 2003**

(30) **Foreign Application Priority Data**

Jan. 21, 2003 (JP) 2003-001235

(51) **LOC (7) Cl.** **12-05**

(52) **U.S. Cl.** **D34/34**

(58) **Field of Search** D34/28, 34; 187/222, 187/237; 414/631; 180/89.12, 89.13, 89.17

(56) **References Cited**

U.S. PATENT DOCUMENTS

- D374,752 S * 10/1996 Lee et al. D34/34
- D411,681 S * 6/1999 Murakami et al. D34/34
- D448,136 S * 9/2001 Yurushi et al. D34/34
- D469,236 S * 1/2003 Mitsuyoshi et al. D34/34

- D470,990 S * 2/2003 Han et al. D34/34
- D471,339 S * 3/2003 Mori D34/34
- D471,340 S * 3/2003 Shibata et al. D34/34
- D471,689 S * 3/2003 Shibata et al. D34/34

FOREIGN PATENT DOCUMENTS

- JP 1045215 7/1999
- JP 1045215-1 12/1999

* cited by examiner

Primary Examiner—Cynthia E. Ramirez

(74) *Attorney, Agent, or Firm*—Morgan & Finnegan, LLP

(57) **CLAIM**

The ornamental design for a forklift truck, as shown and described.

DESCRIPTION

FIG. 1 is a left view showing my forklift truck;
 FIG. 2 is a right view thereof;
 FIG. 3 is a top plan view thereof;
 FIG. 4 is a rear view thereof;
 FIG. 5 is a front view thereof;
 FIG. 6 is a rear perspective view thereof; and,
 FIG. 7 is a front perspective view thereof.

1 Claim, 4 Drawing Sheets

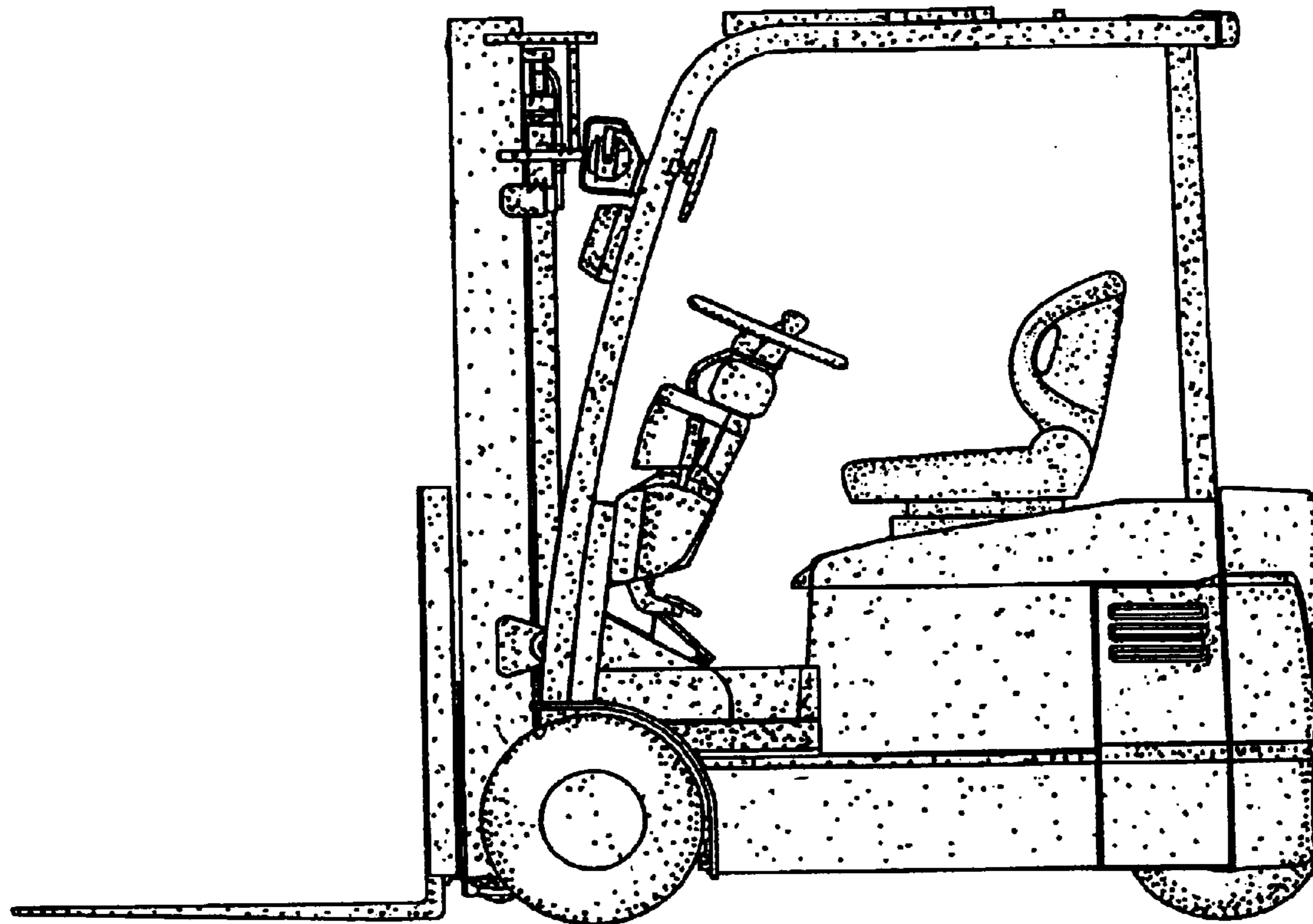

Fig. 1

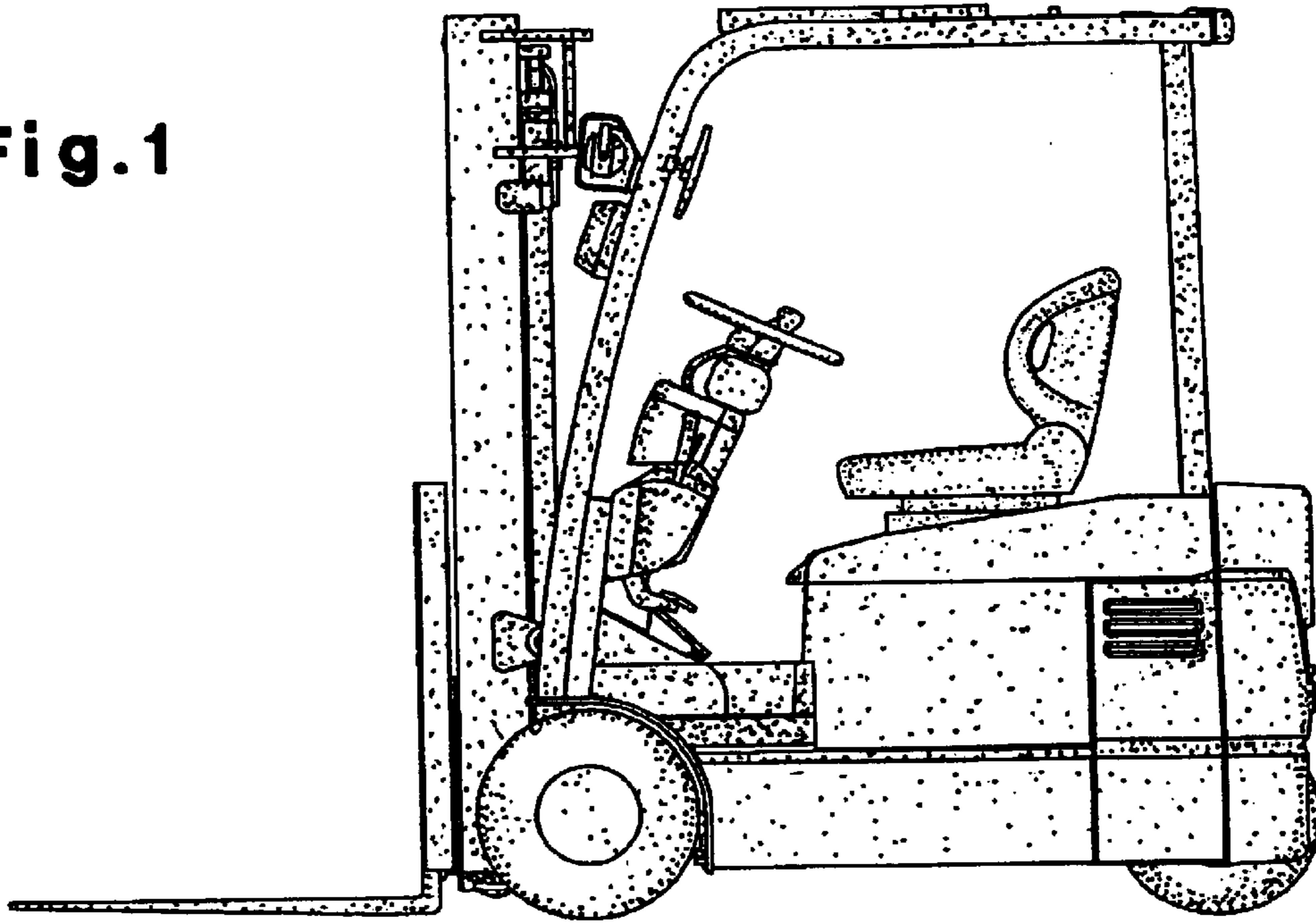

Fig. 2

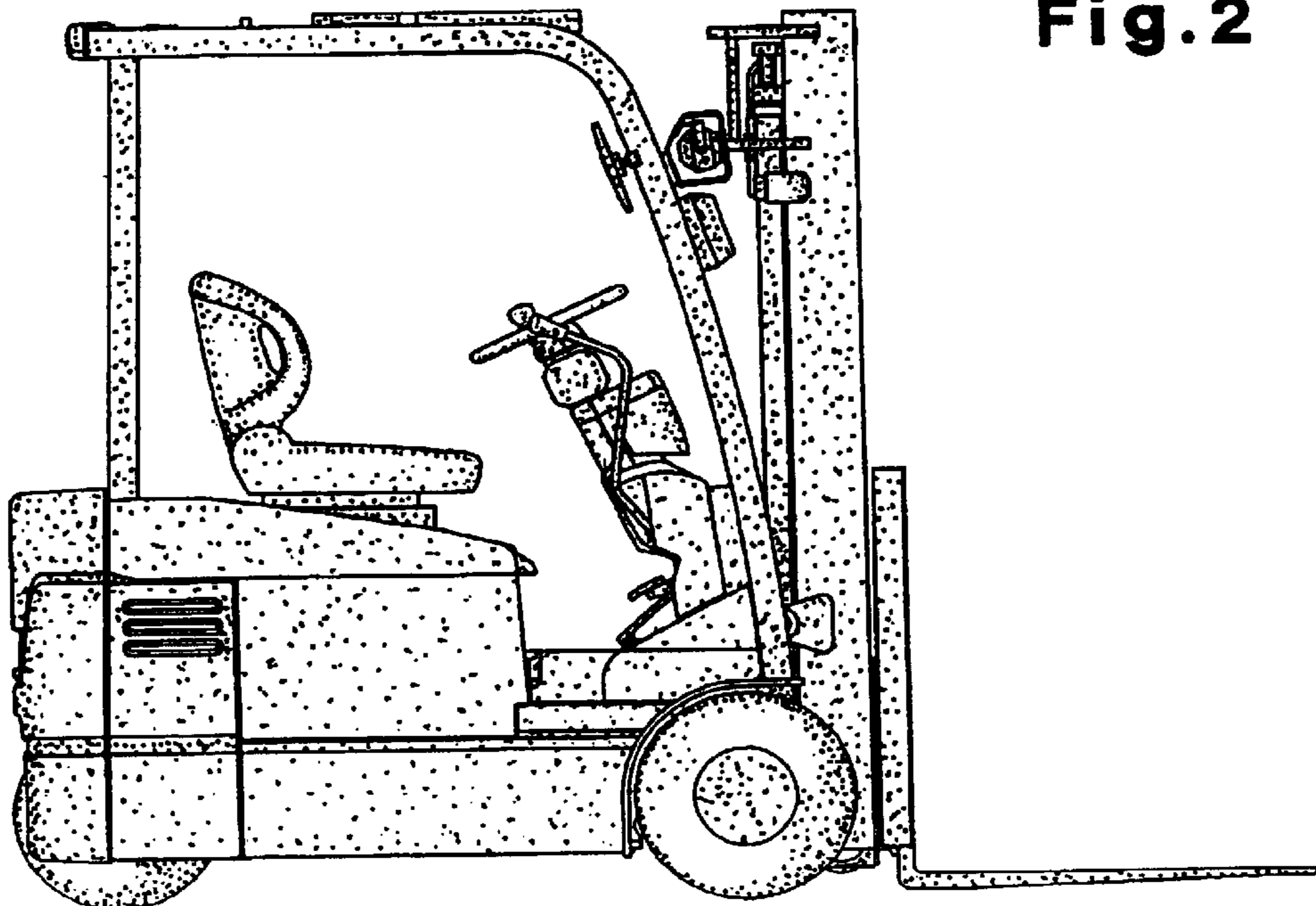

Fig. 3

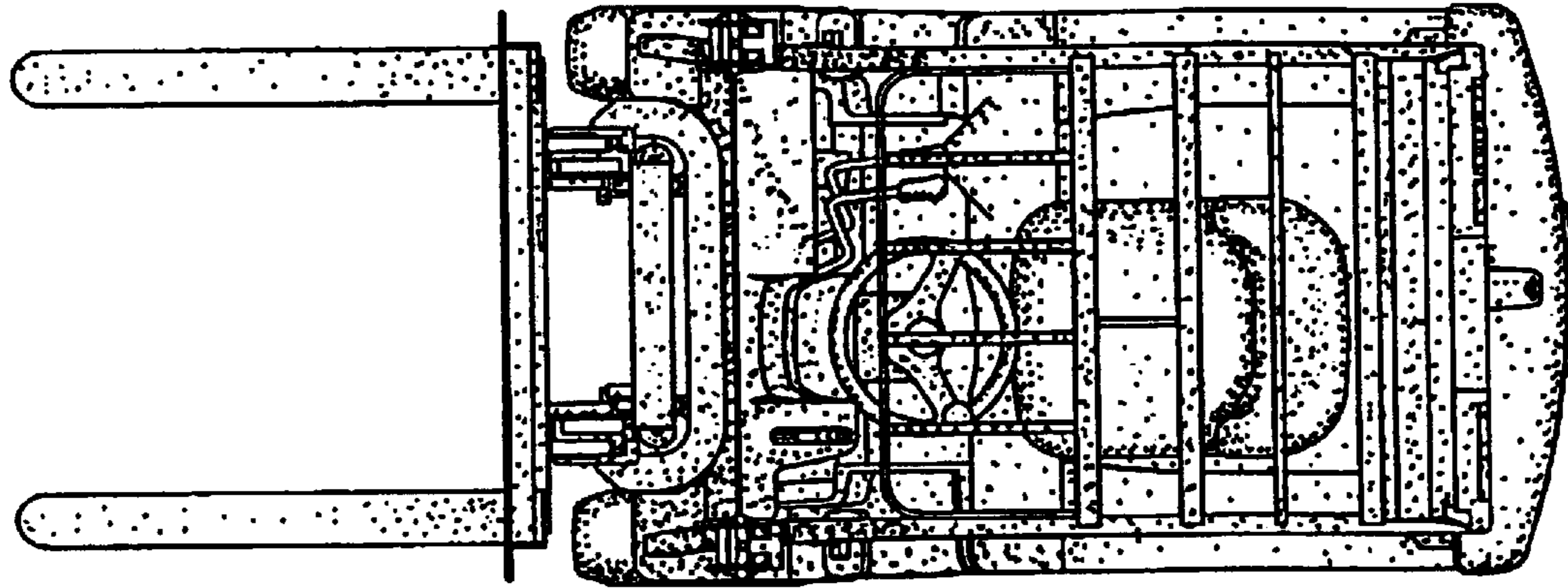

Fig. 4

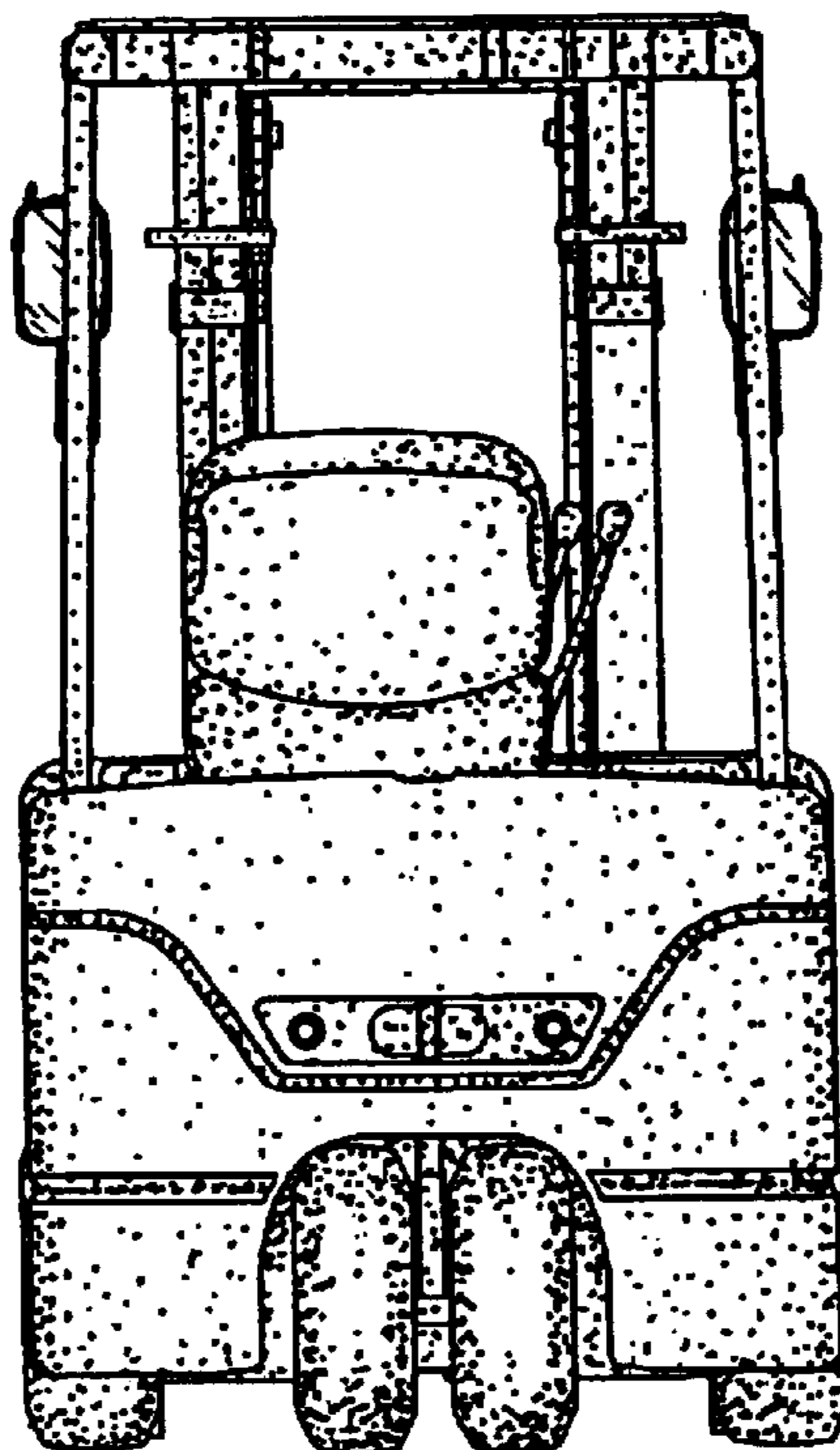

Fig. 5

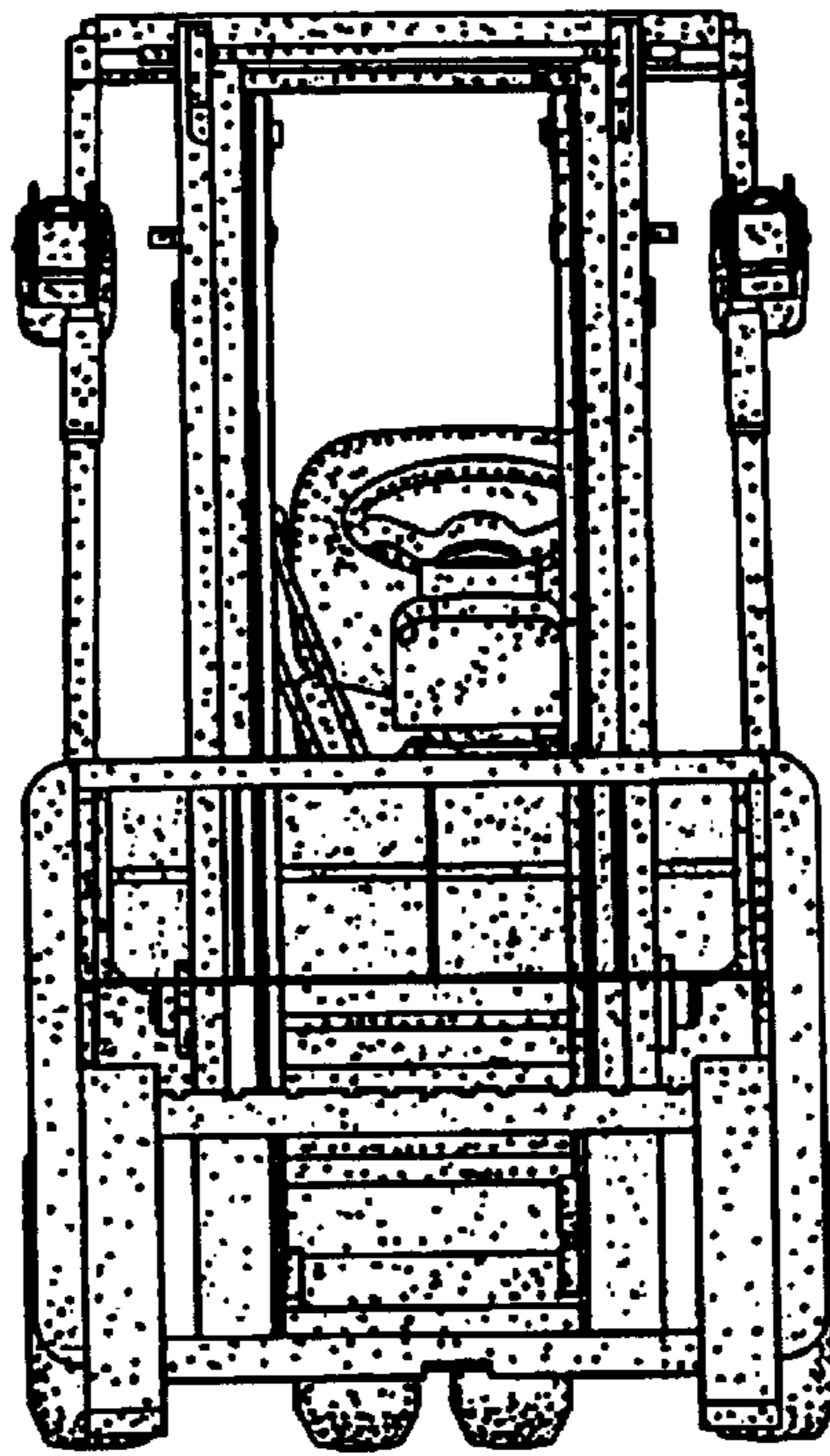

Fig. 6

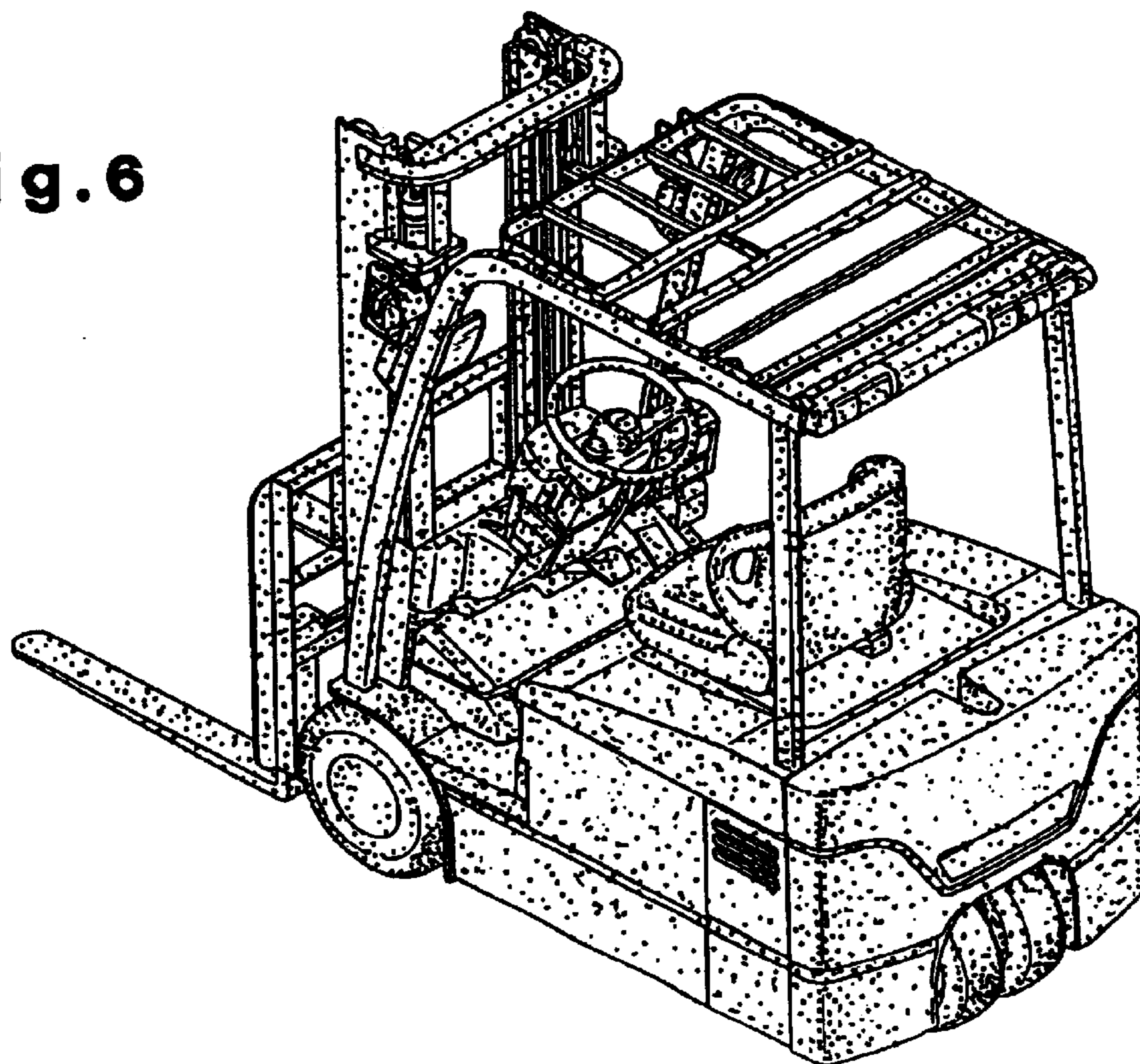

Fig. 7

