



US00D493510S1

(12) **United States Design Patent**
Shahar

(10) **Patent No.:** **US D493,510 S**

(45) **Date of Patent:** **** Jul. 27, 2004**

(54) **FAUCET**

(75) **Inventor:** **Michael Shahar, Yavne (IL)**

(73) **Assignee:** **Hamat Sanitary Fittings and Casting Ltd., Ashdod (IL)**

(**) **Term:** **14 Years**

(21) **Appl. No.:** **29/185,261**

(22) **Filed:** **Jun. 26, 2003**

(51) **LOC (7) Cl.** **23-01**

(52) **U.S. Cl.** **D23/238**

(58) **Field of Search** **D23/238-257;**
4/675-678; 137/801

(56) **References Cited**

U.S. PATENT DOCUMENTS

- D471,255 S * 3/2003 Friedrich D23/238
- D473,929 S * 4/2003 Warshawsky et al. D23/238

D478,150 S * 8/2003 Friedrich D23/238

* cited by examiner

Primary Examiner—Louis S. Zarfes

Assistant Examiner—Gregory Andoll

(74) *Attorney, Agent, or Firm*—Dennison, Schultz, Dougherty & MacDonald

(57) **CLAIM**

The ornamental design for a faucet, as shown and described.

DESCRIPTION

FIG. 1 is a front elevational view thereof of a faucet showing the new design;

FIG. 2 is a rear elevational view thereof;

FIG. 3 is a left side elevational view thereof;

FIG. 4 is a right side elevational view thereof;

FIG. 5 is a top view thereof;

FIG. 6 is a bottom view thereof; and,

FIG. 7 is a perspective view of the faucet showing the new design.

1 Claim, 5 Drawing Sheets

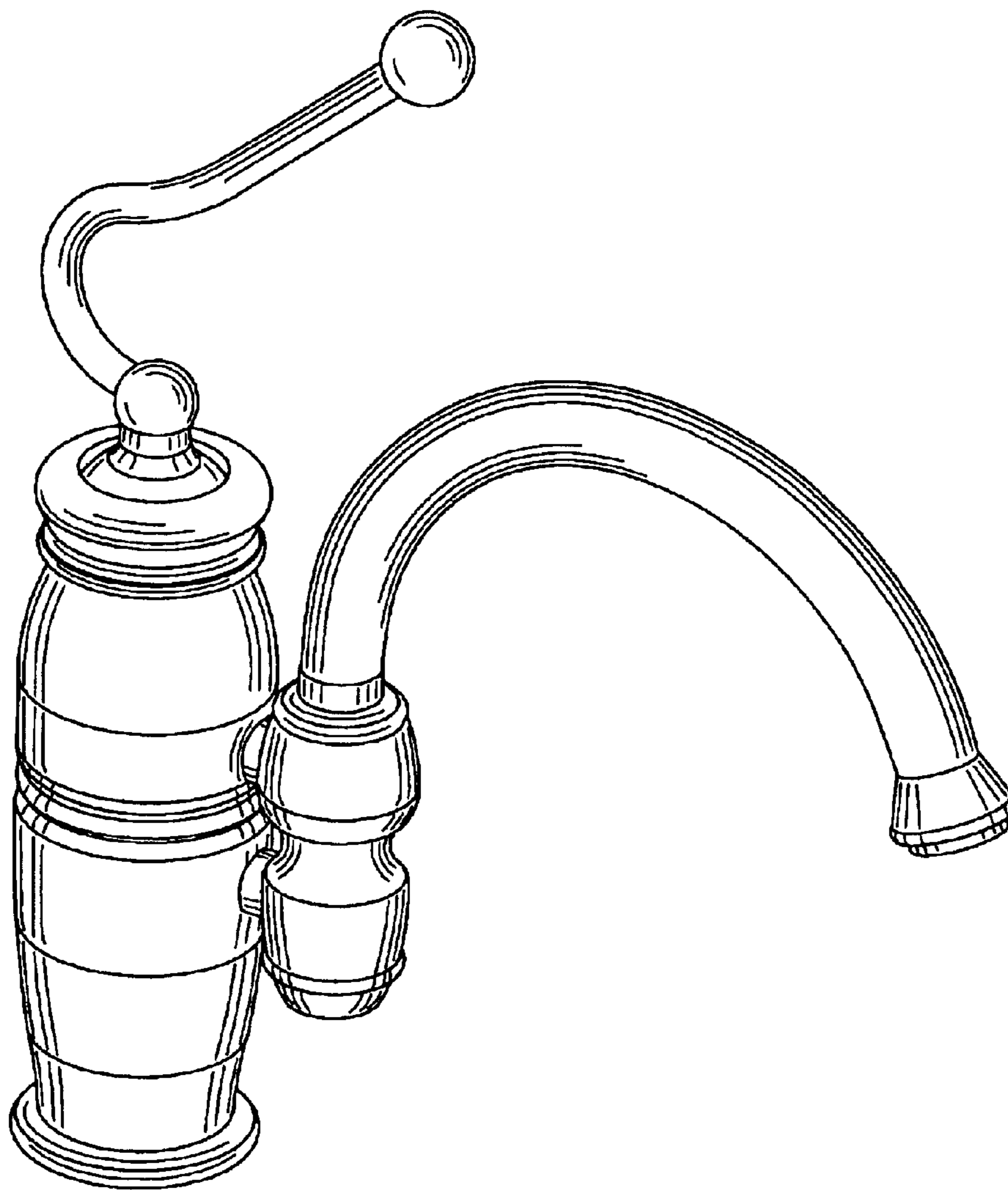

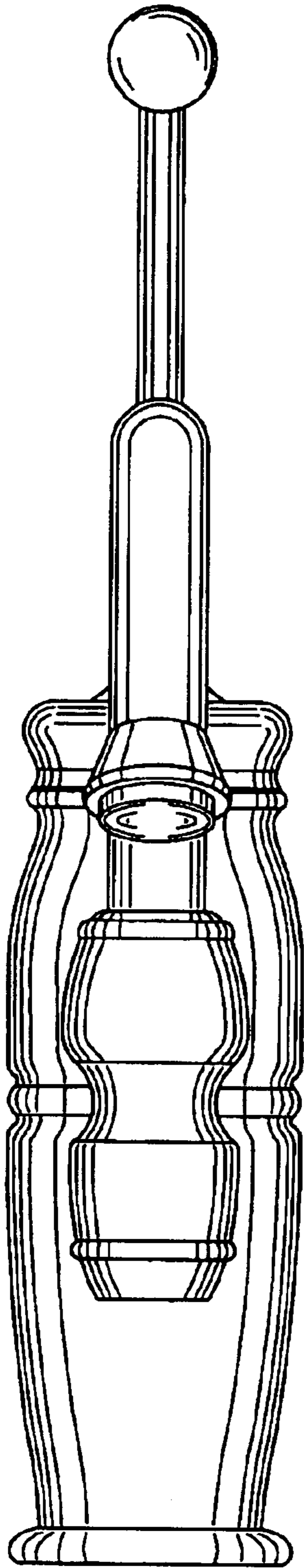

FIG. 1

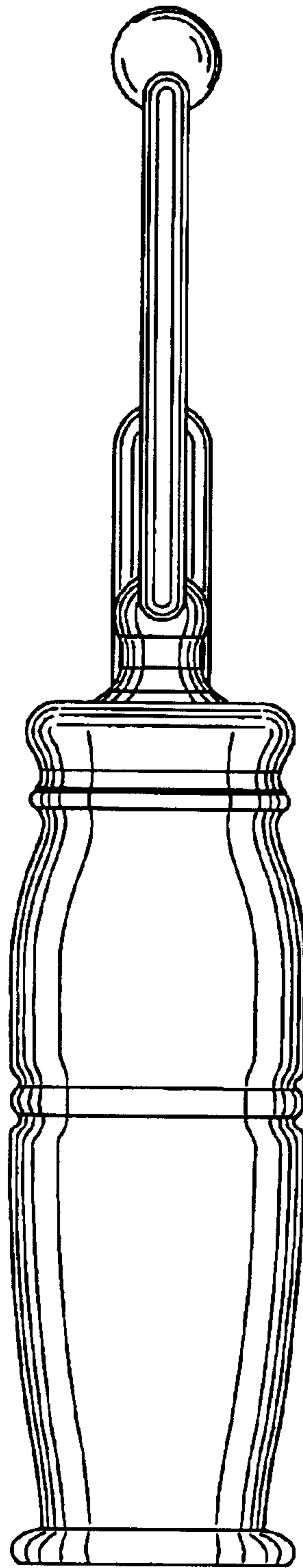

FIG. 2

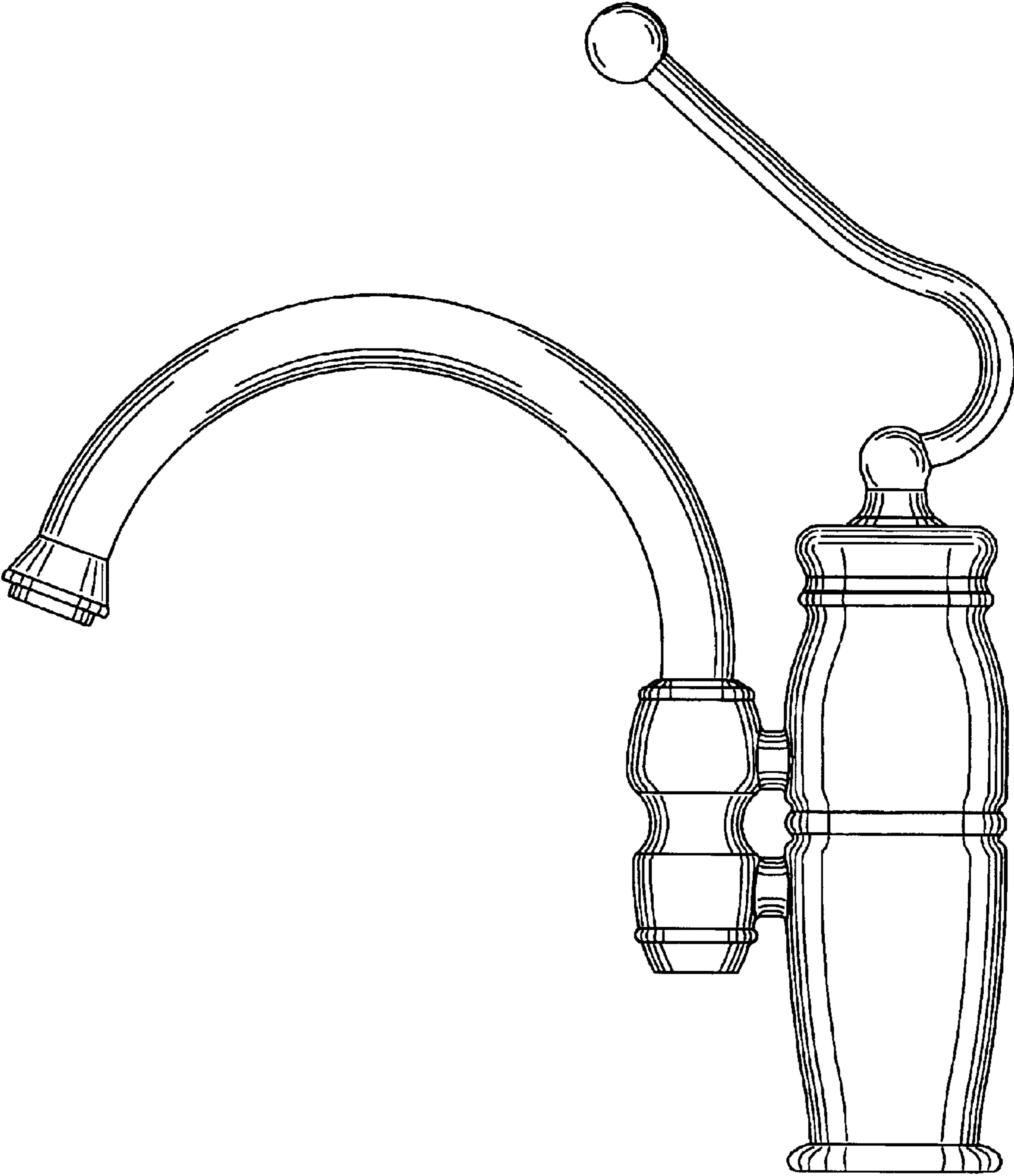

FIG.3

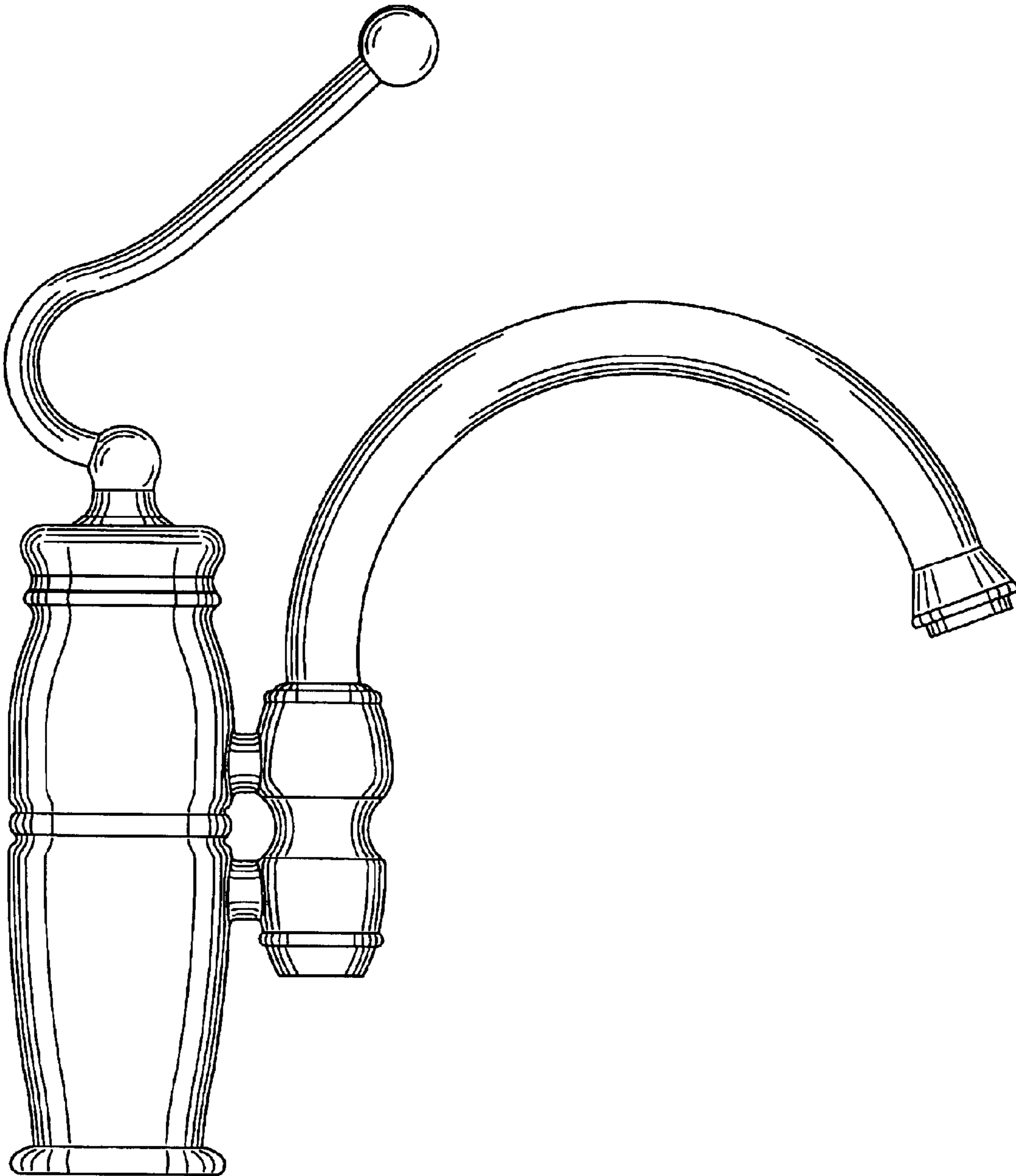

FIG.4

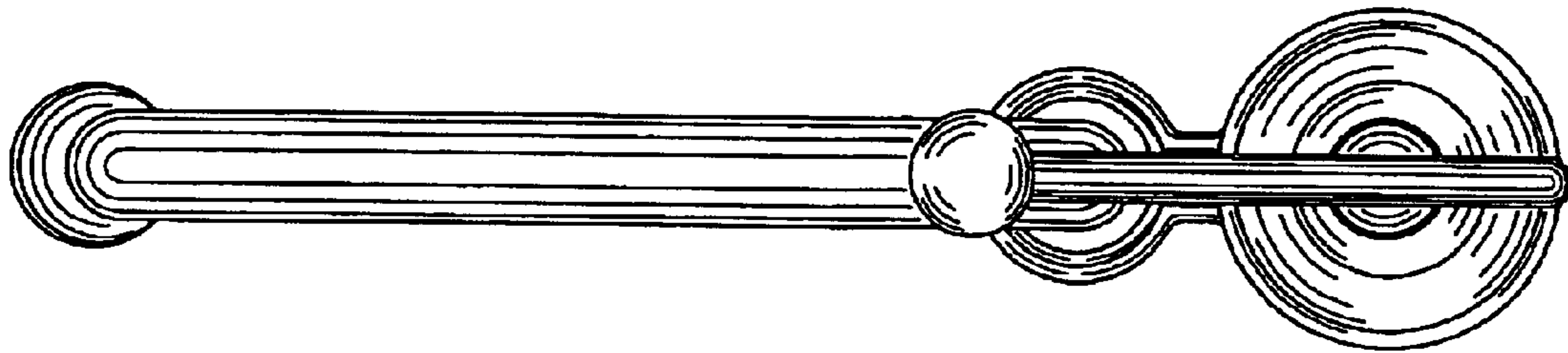

FIG. 5

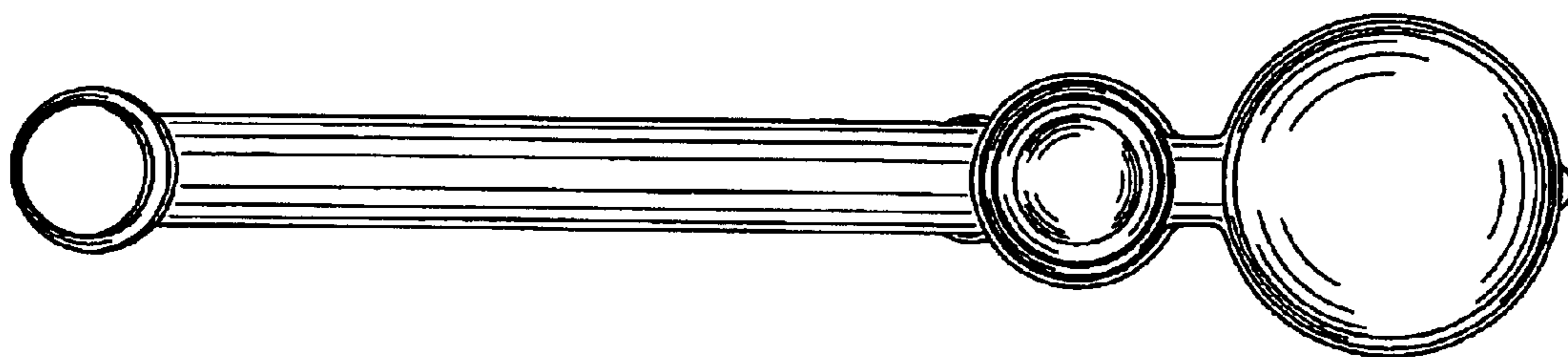

FIG. 6

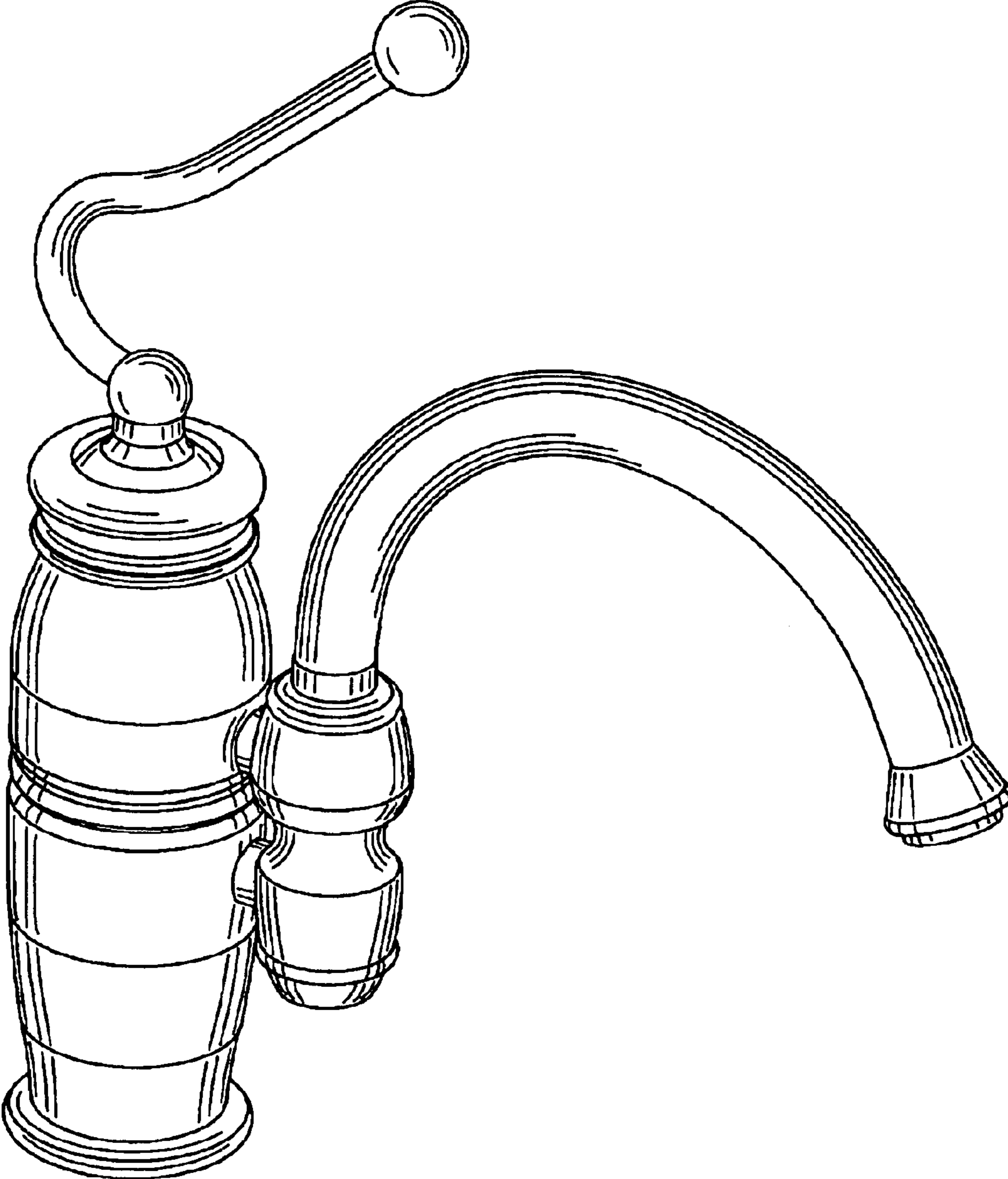

FIG. 7