



US00D493468S1

(12) **United States Design Patent** (10) **Patent No.:** **US D493,468 S**  
**Serbinski et al.** (45) **Date of Patent:** **\*\* Jul. 27, 2004**

(54) **UPPER PORTION OF A FLAT PANEL MONITOR STAND SUPPORT ARM**

6,378,830 B1 \* 4/2002 Lu ..... 248/278.1  
 6,517,040 B1 \* 2/2003 Wen ..... 248/278.1  
 2003/0075649 A1 \* 4/2003 Jeong et al. .... 248/157  
 2003/0174259 A1 \* 9/2003 Yang ..... 349/58

(75) Inventors: **Andrew Serbinski**, Annandale, NJ (US); **Jason C. Billig**, Hoboken, NJ (US); **Mirzat Koc**, Brooklyn, NY (US); **Mark I. Rosen**, Franklin Lakes, NJ (US)

**OTHER PUBLICATIONS**

U.S. patent application Ser. No. D-29/414,164, Rorke et al., filed Sep. 21, 1999.

(73) Assignee: **3M Innovative Properties Company**, St. Paul, MN (US)

\* cited by examiner

(\*\*) Term: **14 Years**

*Primary Examiner*—Kay H. Chin  
 (74) *Attorney, Agent, or Firm*—Robert J. Pechman

(21) Appl. No.: **29/195,165**

(57) **CLAIM**

(22) Filed: **Dec. 8, 2003**

The ornamental design for an upper portion of a flat panel monitor stand support arm, as shown and described.

**Related U.S. Application Data**

**DESCRIPTION**

(62) Division of application No. 29/158,555, filed on Apr. 5, 2002, now Pat. No. Des. 487,094.

FIG. 1 is a front perspective view of an upper portion of a flat panel monitor stand support arm showing our new design;

(51) **LOC (7) Cl.** ..... **14-02**

(52) **U.S. Cl.** ..... **D14/451**

FIG. 2 is a rear perspective view thereof;

(58) **Field of Search** ..... D14/448, 451, D14/452, 239; 361/681, 682; 248/917, 918, 919, 346.01, 278.1, 157; 349/58

FIG. 3 is a side view thereof;

FIG. 4 is a front view thereof;

(56) **References Cited**

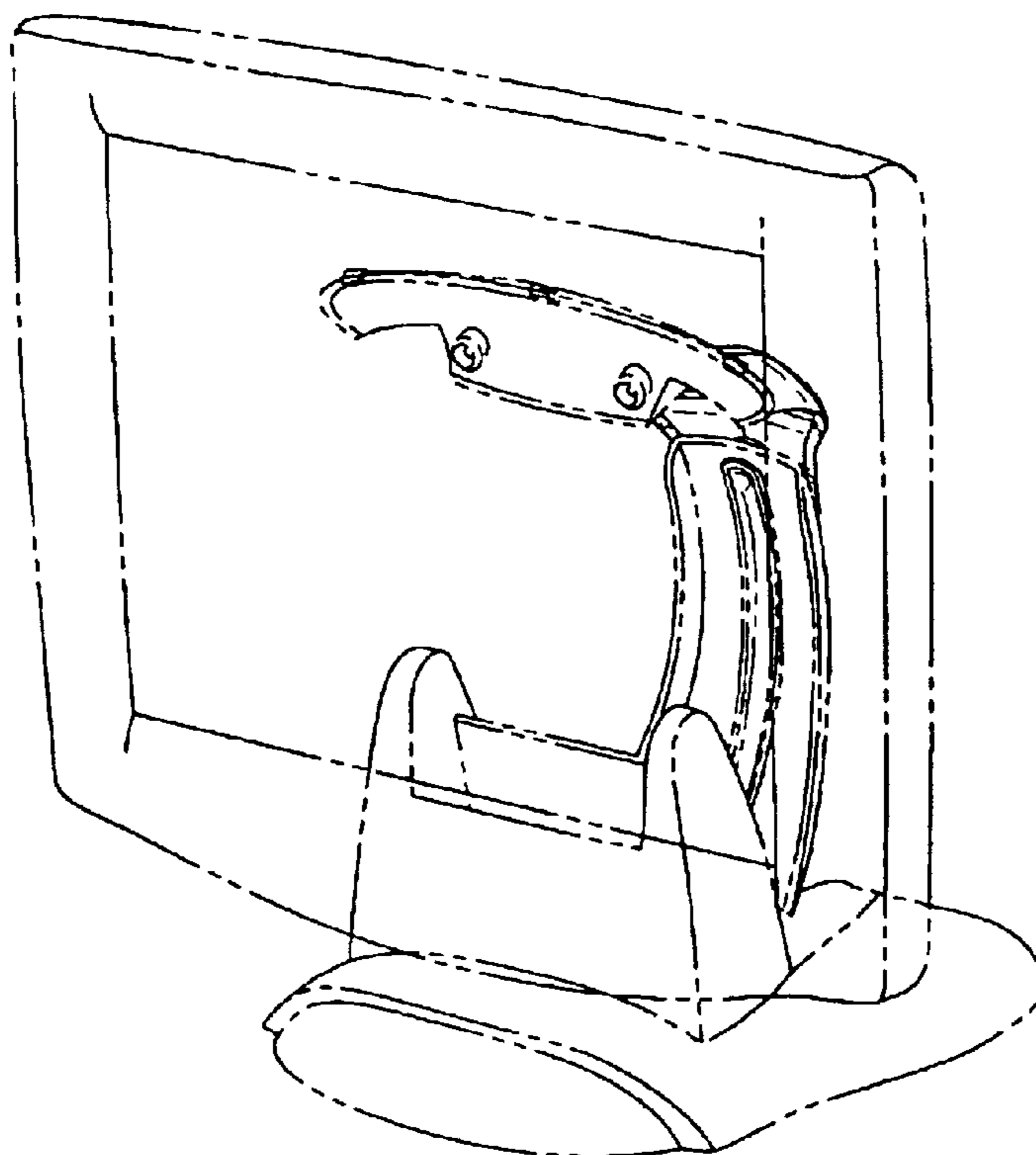
FIG. 5 is a rear view thereof; and,

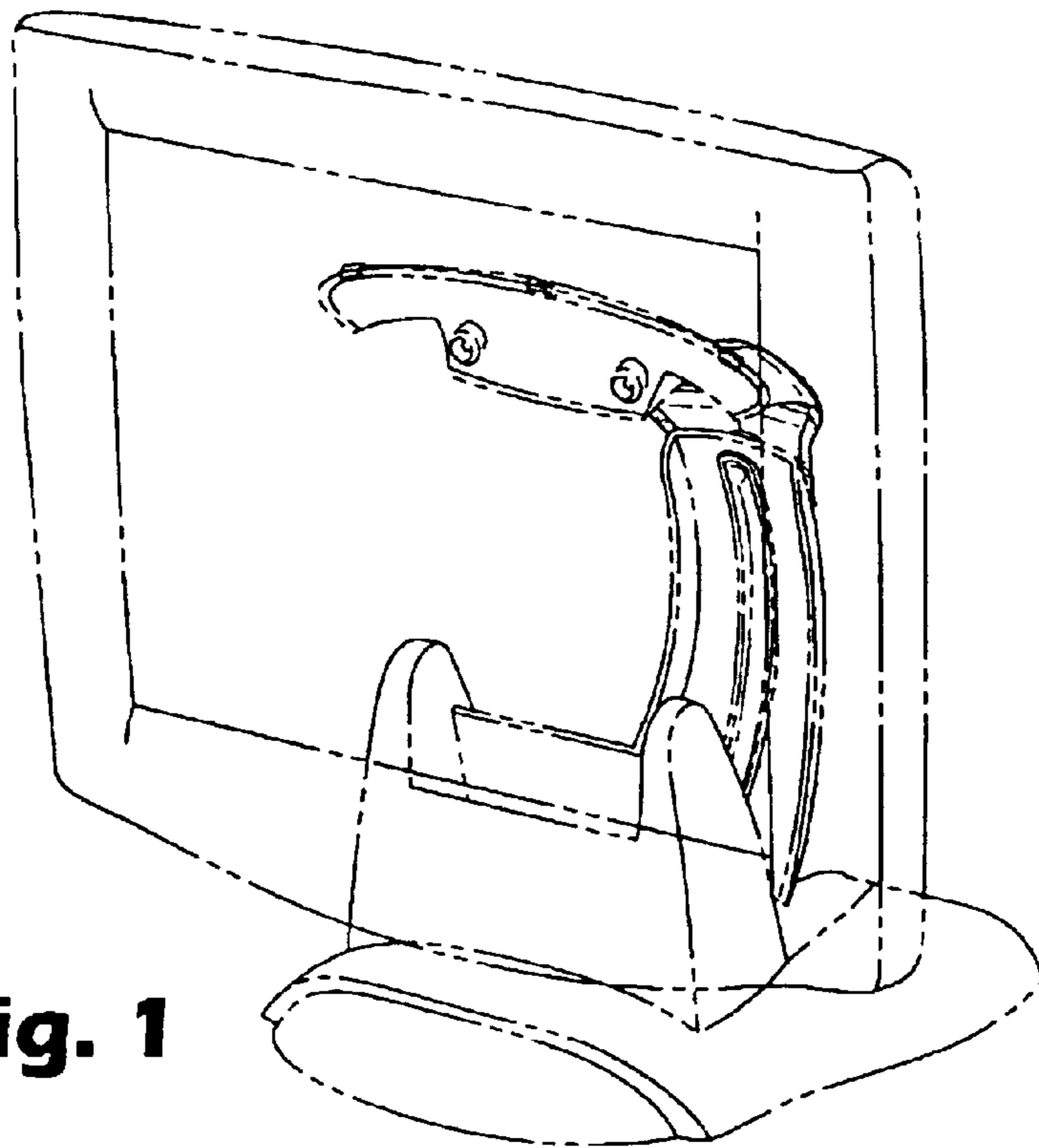
FIG. 6 is a top view thereof.

**U.S. PATENT DOCUMENTS**

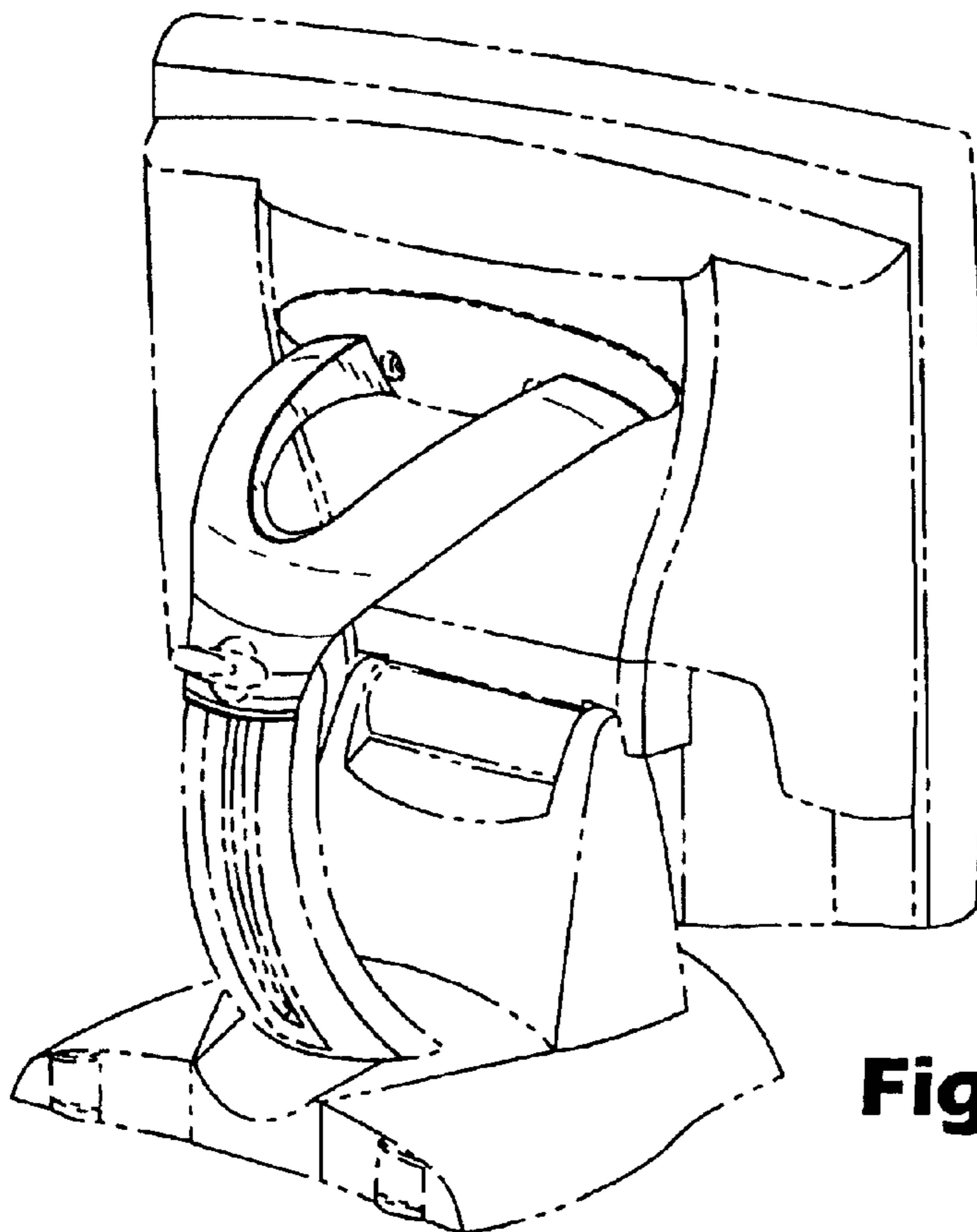
D415,768 S \* 10/1999 Howell ..... D14/451

**1 Claim, 3 Drawing Sheets**

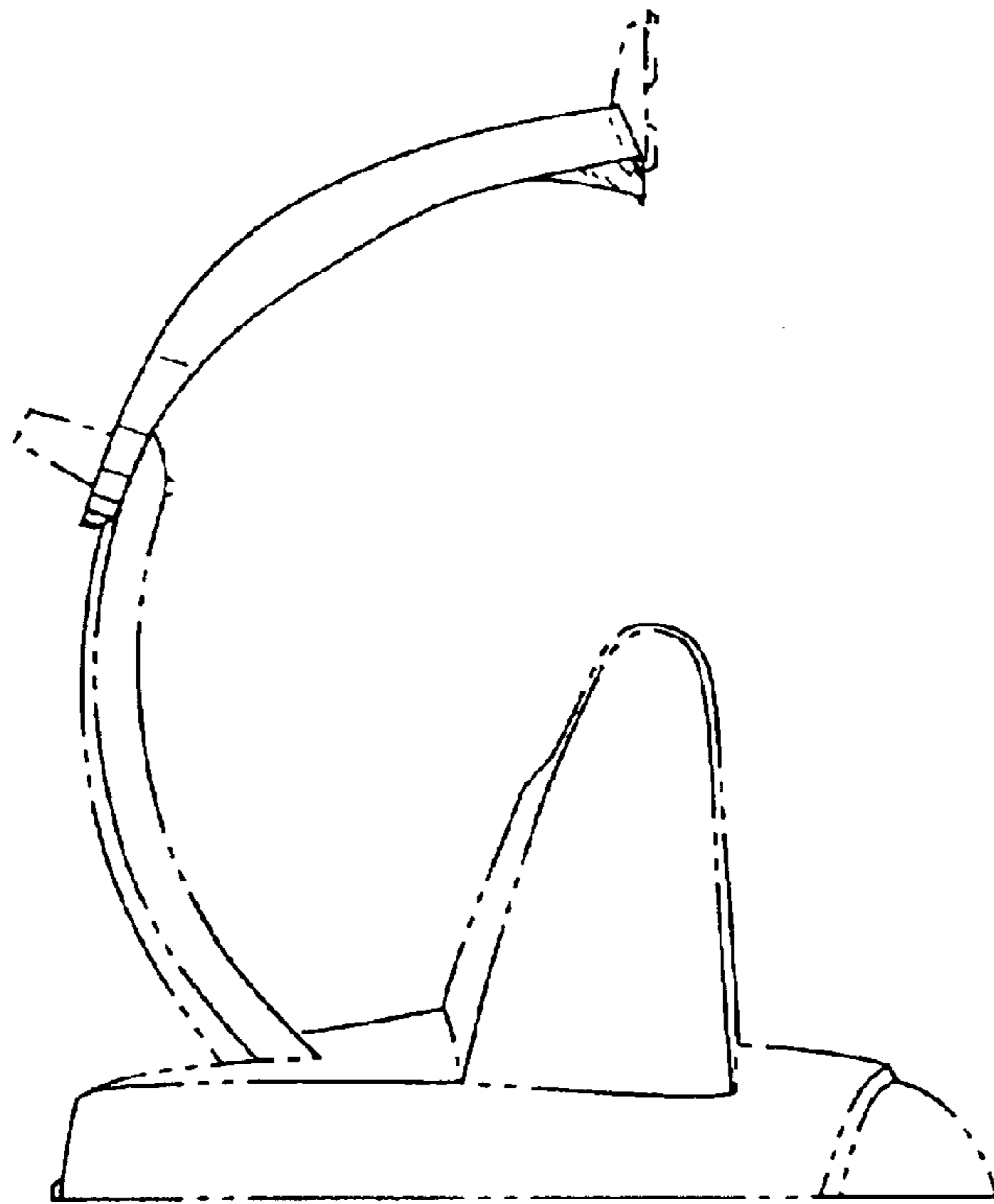




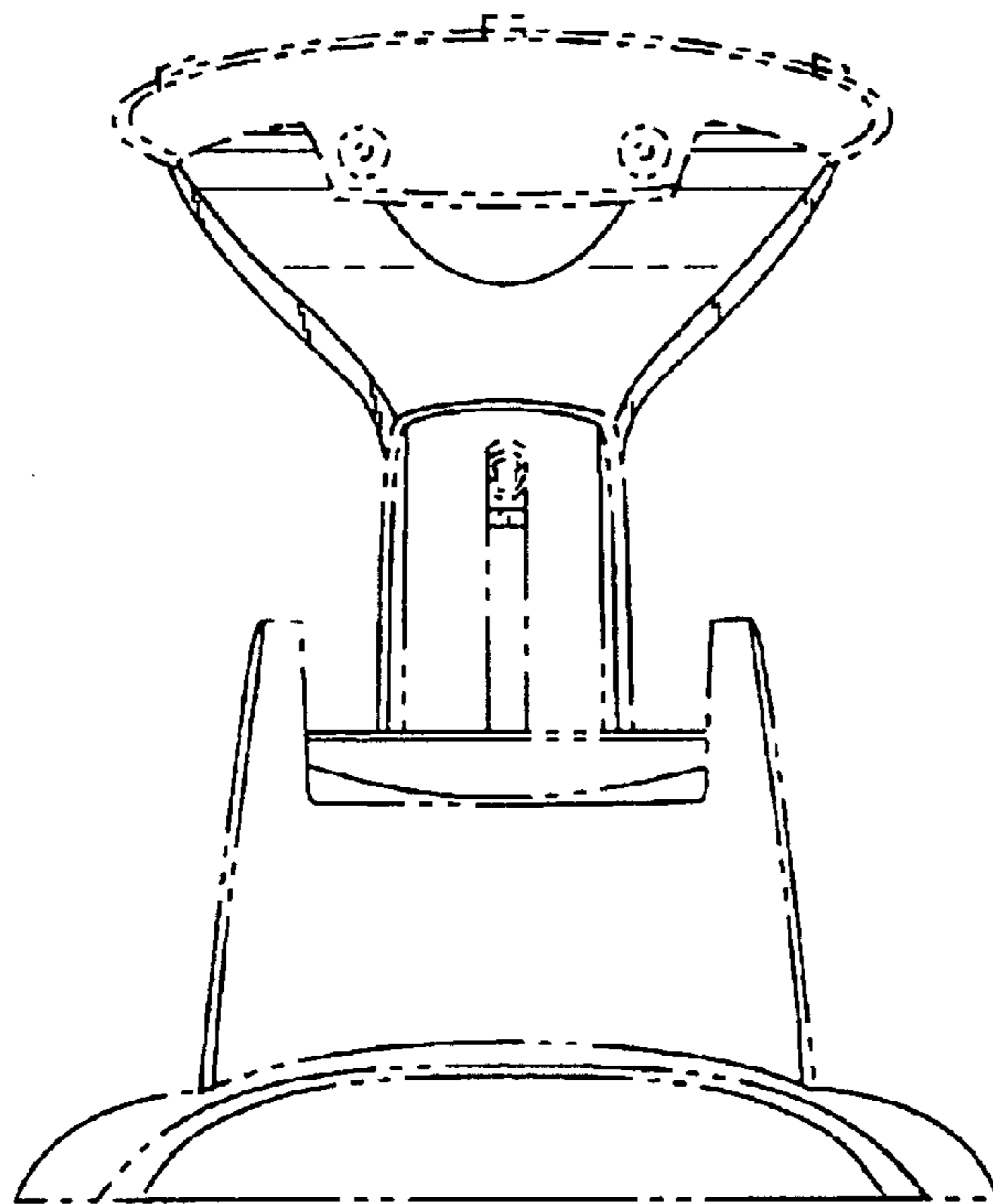
**Fig. 1**



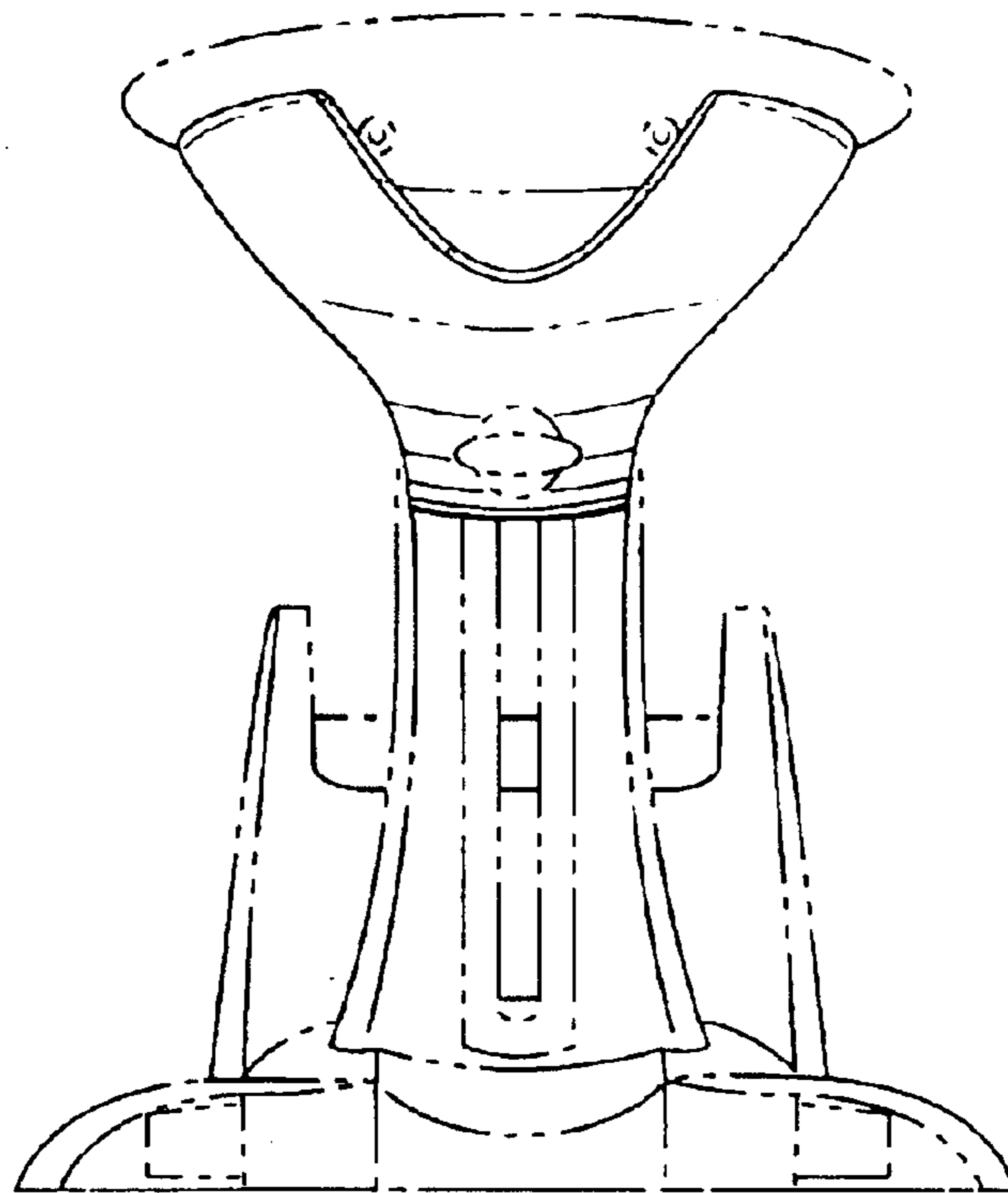
**Fig. 2**



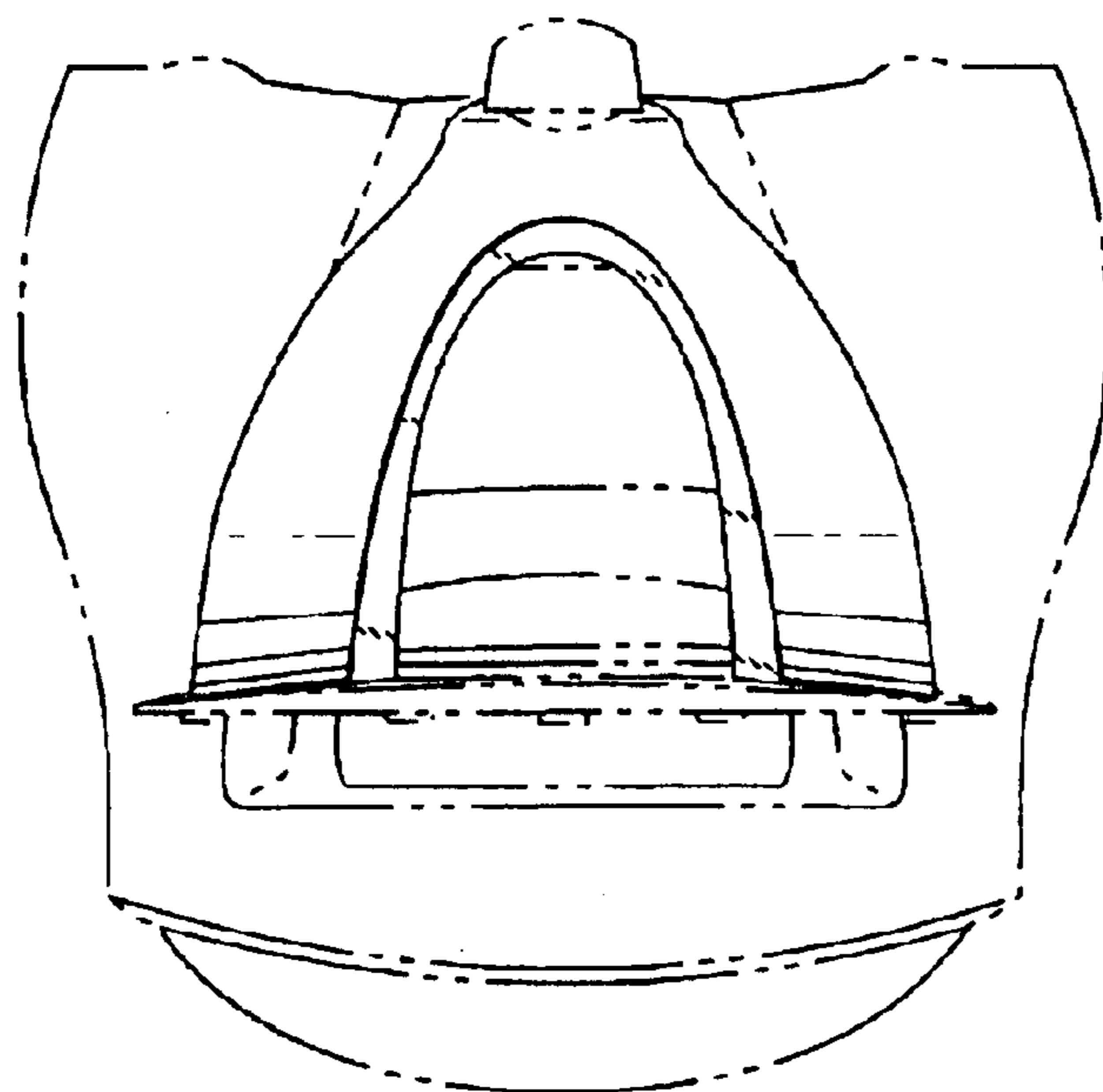
**Fig. 3**



**Fig. 4**



**Fig. 5**



**Fig. 6**