

US00D493447S1

(12) **United States Design Patent**
Noro et al.

(10) **Patent No.:** **US D493,447 S**
(45) **Date of Patent:** **** Jul. 27, 2004**

(54) **ANTENNA**

D325,733 S * 4/1992 Suzuki et al. D14/155
D470,481 S * 2/2003 Ikeda D14/230

(75) Inventors: **Junichi Noro**, Minamiakita-gun (JP);
Yuichi Saito, Minamiakita-gun (JP);
Kyuichi Sato, Minamiakita-gun (JP)

* cited by examiner

(73) Assignee: **Mitsumi Electric Co. Ltd.**, Tokyo (JP)

Primary Examiner—Louis S. Zarfes
Assistant Examiner—Deanne Levy
(74) *Attorney, Agent, or Firm*—Sughrue Mion, PLLC

(**) Term: **14 Years**

(57) **CLAIM**

(21) Appl. No.: **29/182,994**

The ornamental design for an antenna, as shown and described.

(22) Filed: **Jun. 5, 2003**

DESCRIPTION

(30) **Foreign Application Priority Data**

Dec. 5, 2002 (JP) 2002-033678

FIG. 1 is a perspective view of the top, front and right side of an antenna showing our new design;
FIG. 2 is a perspective view of the bottom, rear and left side thereof;
FIG. 3 is a top plan view thereof;
FIG. 4 is a front elevational view thereof;
FIG. 5 is a right side elevational view thereof, the left side being a mirror image thereof;
FIG. 6 is a rear elevational view thereof; and,
FIG. 7 is a bottom plan view thereof.

(51) **LOC (7) Cl.** **14-03**

(52) **U.S. Cl.** **D14/230**

(58) **Field of Search** D14/230, 232,
D14/238, 299; 343/711, 872, 908; 455/90,
128, 347, 562; D10/106

(56) **References Cited**

U.S. PATENT DOCUMENTS

D238,154 S * 12/1975 Tipton D10/106

1 Claim, 3 Drawing Sheets

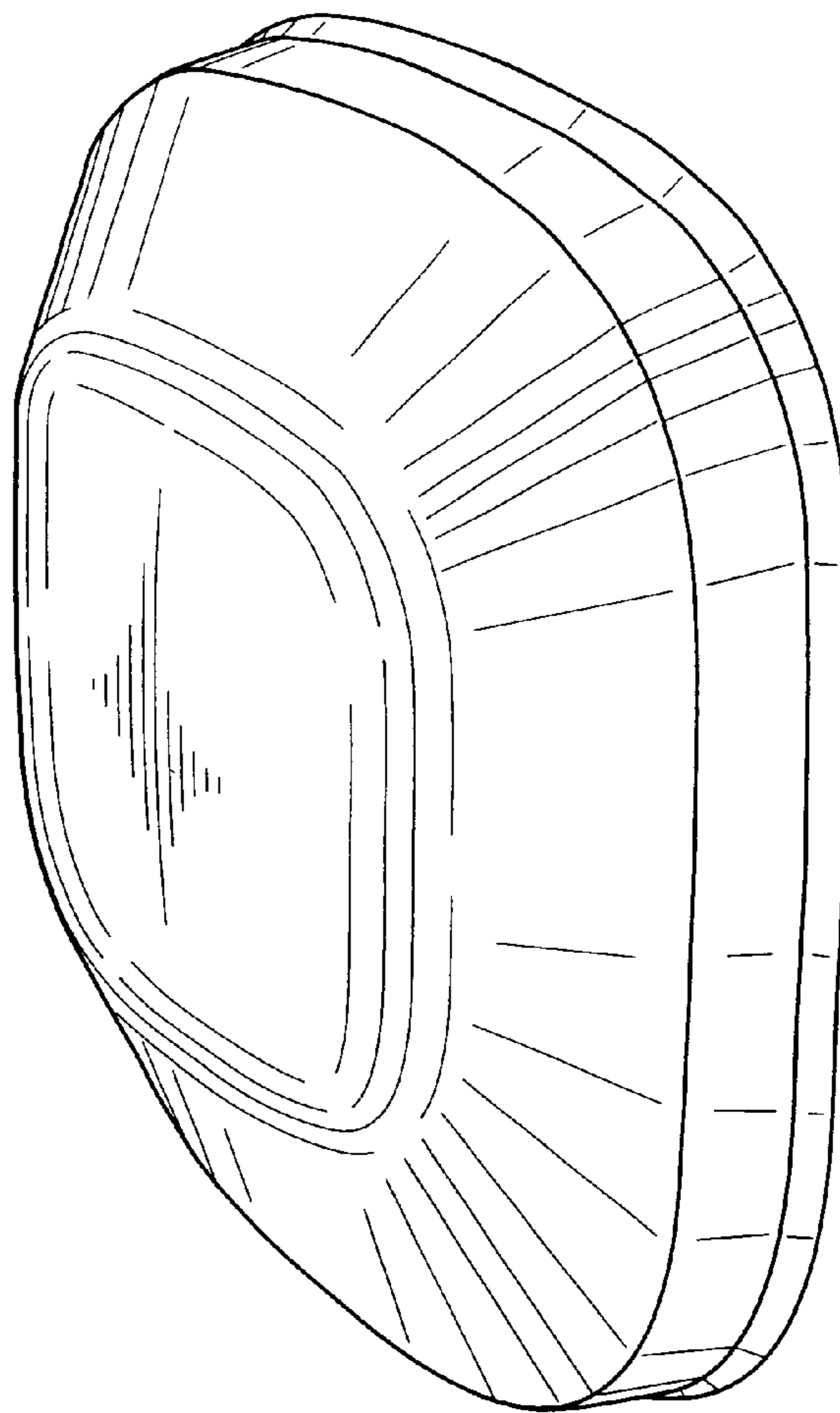

FIG. 1

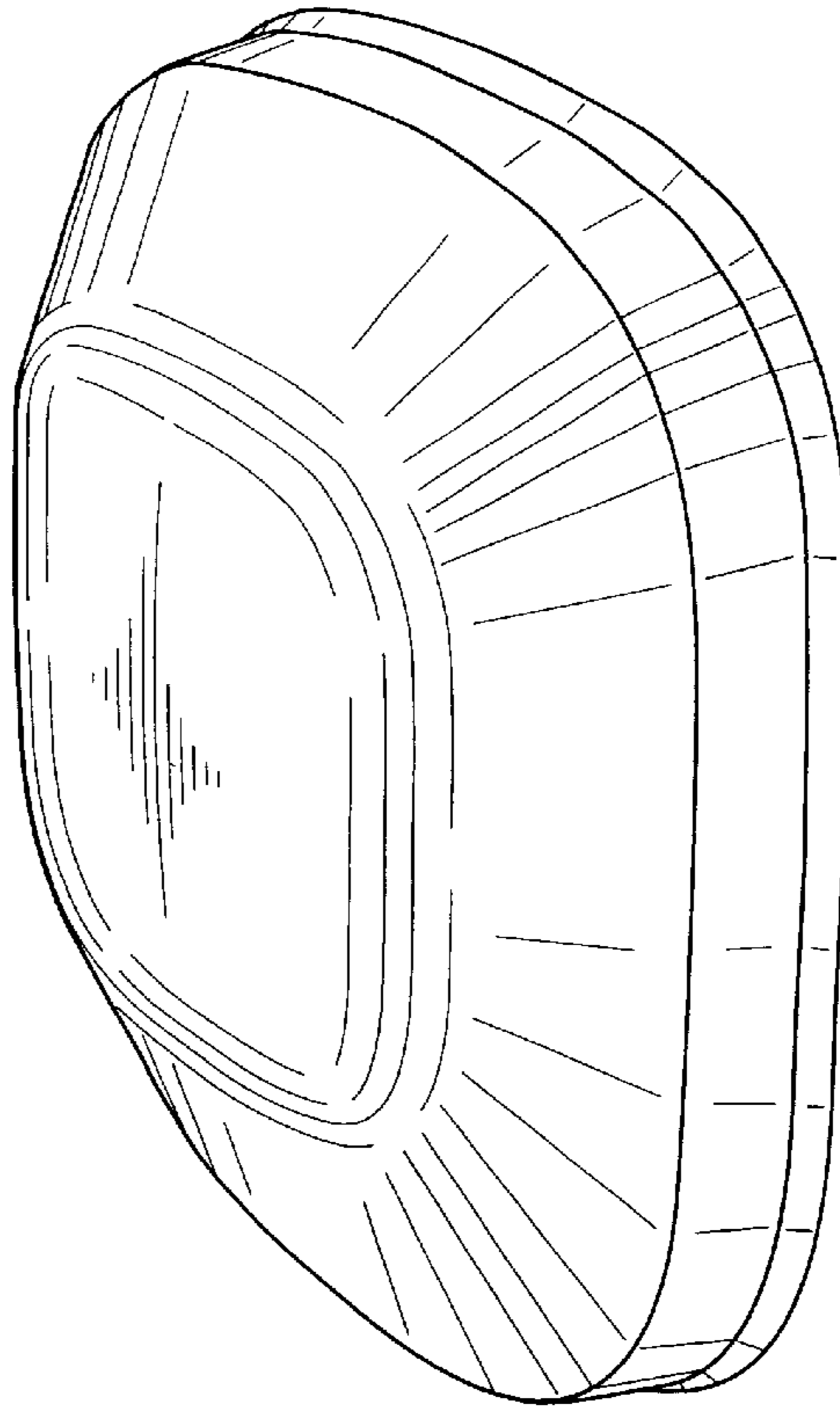

FIG. 2

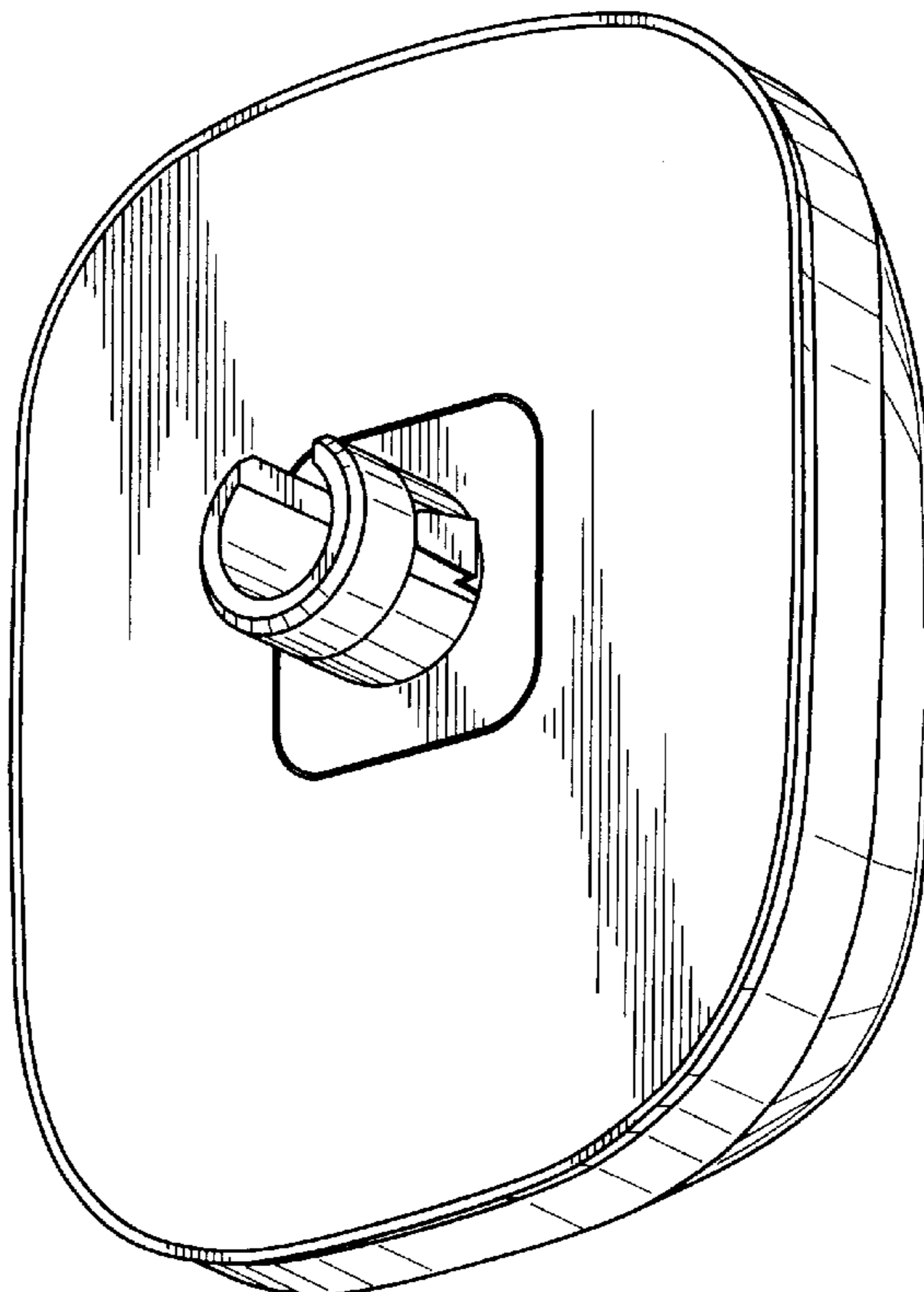

FIG. 3

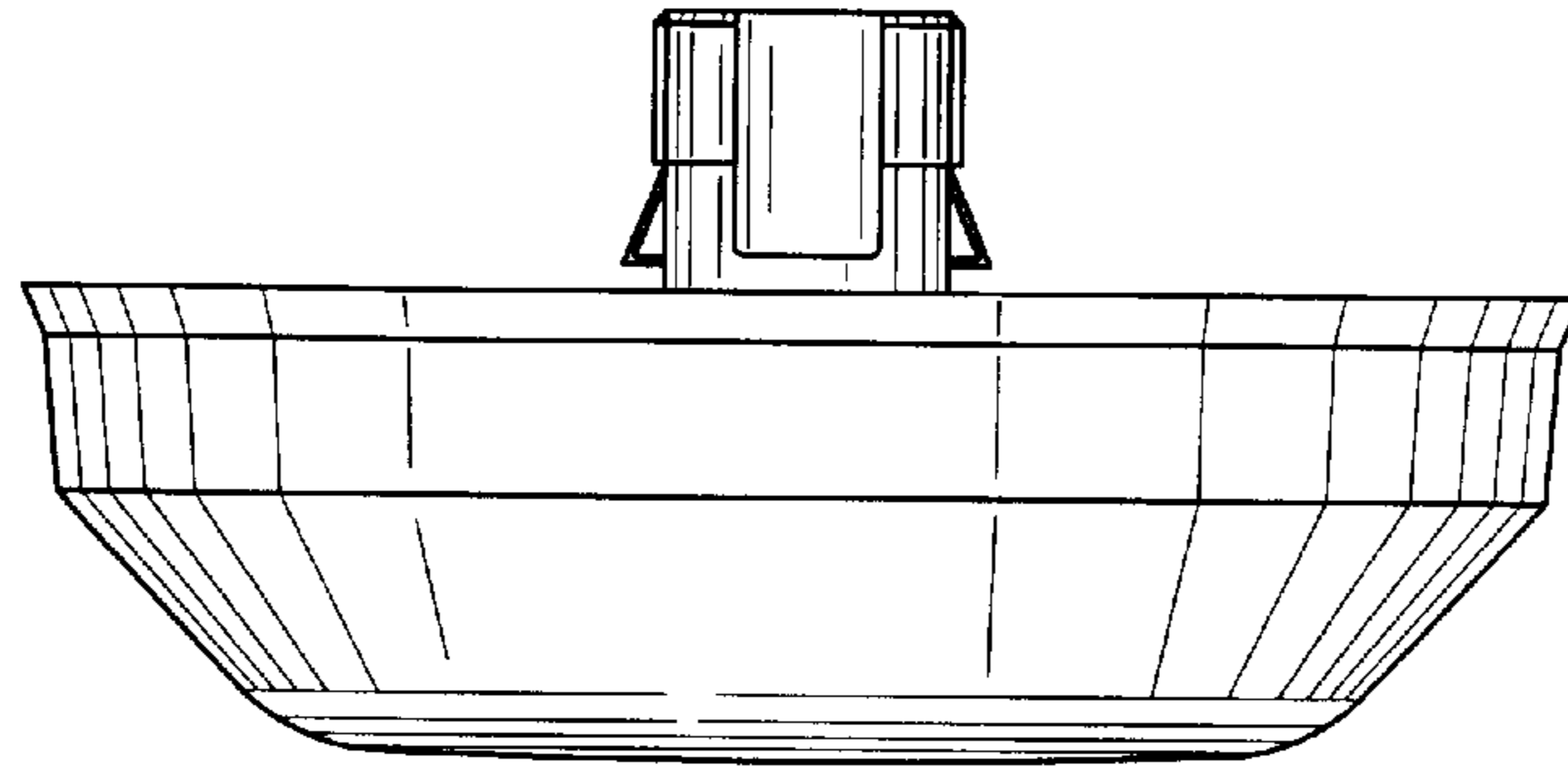

FIG. 4

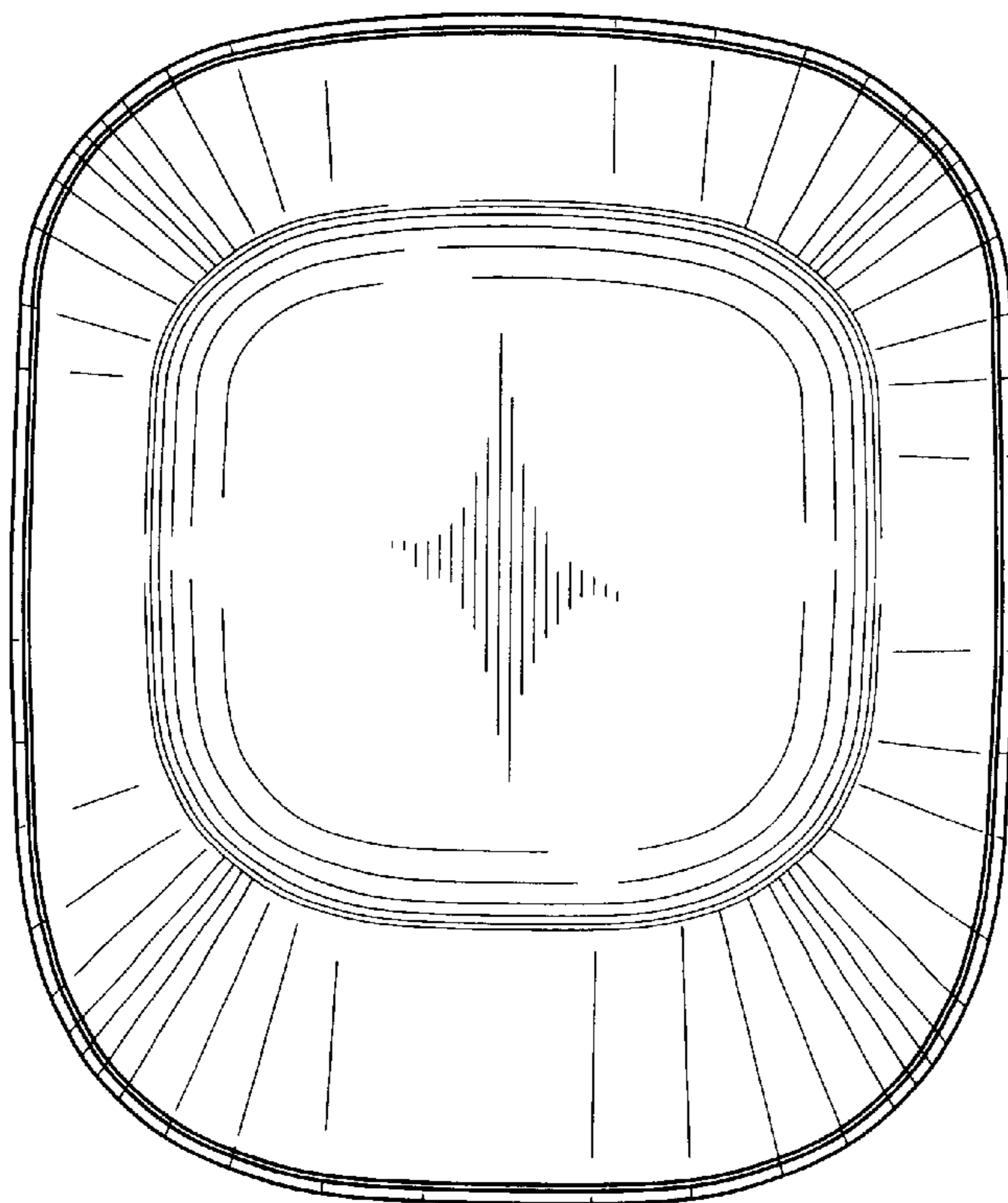

FIG. 5

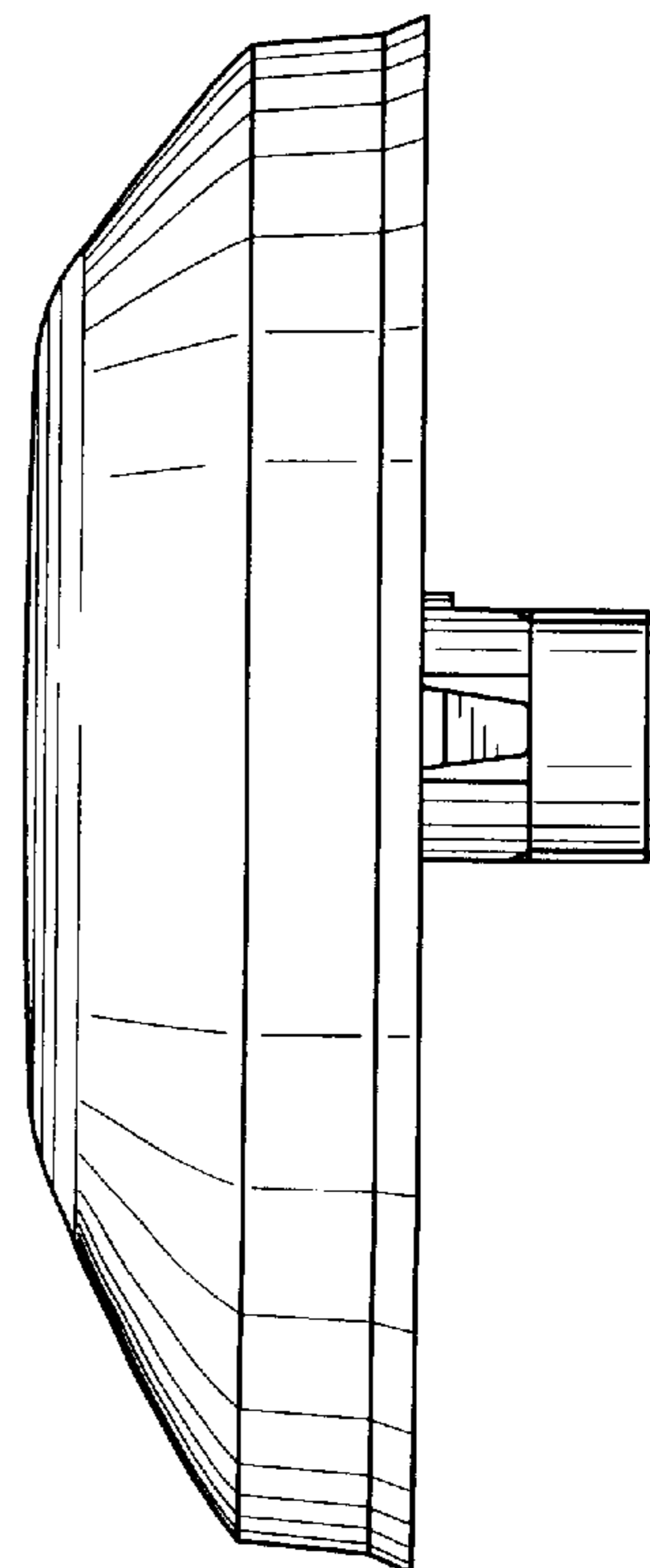

FIG. 6

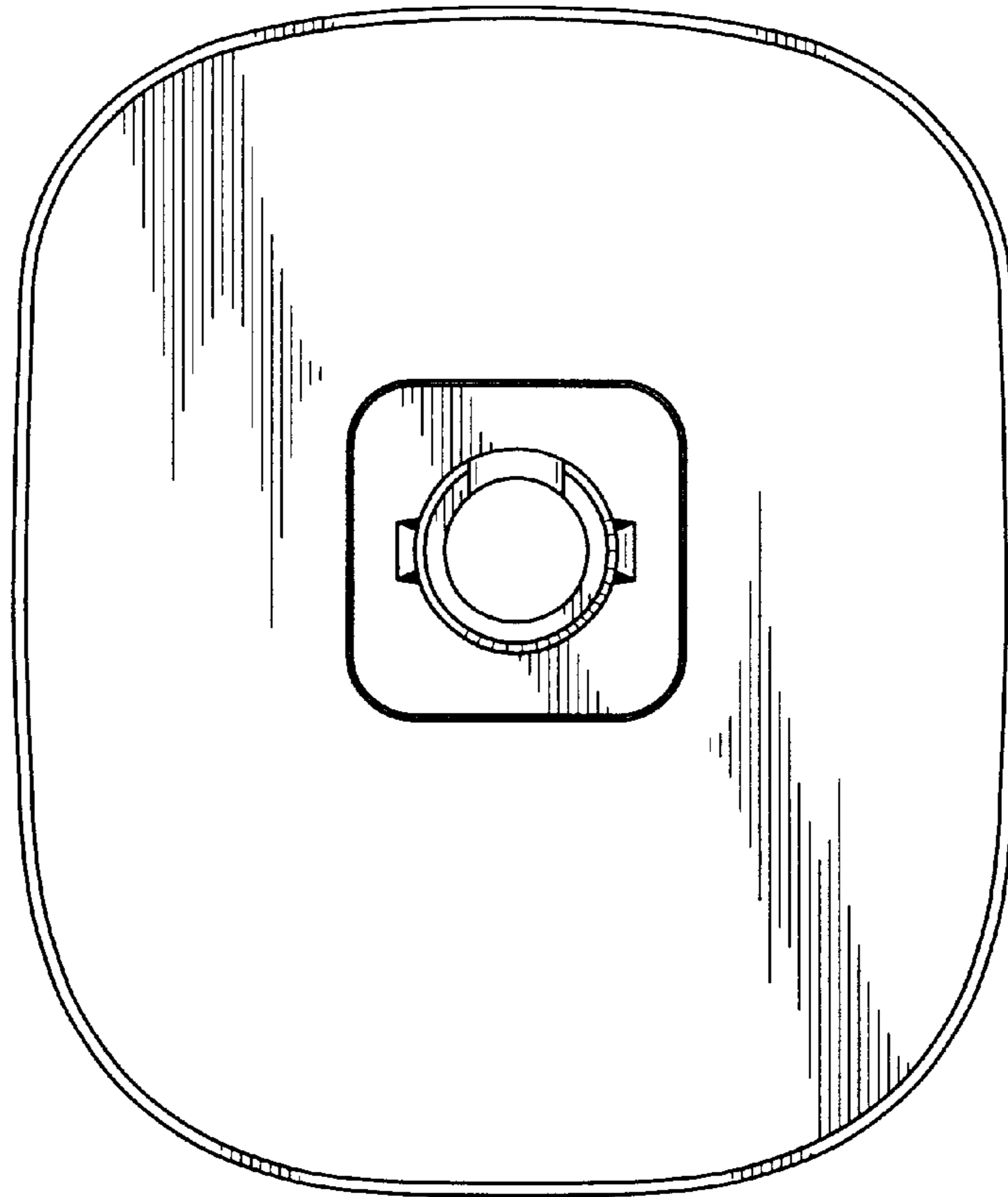

FIG. 7

