

US00D493368S1

(12) **United States Design Patent**  
**Goda**

(10) **Patent No.:** **US D493,368 S**  
(45) **Date of Patent:** **\*\* Jul. 27, 2004**

(54) **BOTTLE**

(75) **Inventor:** **Mark E. Goda**, Greenville, PA (US)

(73) **Assignee:** **Snapple Beverage Corp.**, White Plains, NY (US)

(\*\*) **Term:** **14 Years**

(21) **Appl. No.:** **29/174,293**

(22) **Filed:** **Jan. 15, 2003**

(51) **LOC (7) Cl.** ..... **09-01**

(52) **U.S. Cl.** ..... **D9/502; D9/538**

(58) **Field of Search** ..... D9/500, 300, 502-504,  
D9/516, 530, 537-539, 557-558; 215/382-384,  
396, 398, 400, 375; 220/666, 669, 675

(56) **References Cited**

**U.S. PATENT DOCUMENTS**

D212,321 S	*	10/1968	Hilld	.....	D9/502
D297,308 S	*	8/1988	Lyons	.....	D9/502
D375,684 S	*	11/1996	Hope	.....	D9/502
D382,806 S	*	8/1997	Wilson et al.	.....	D9/502
D396,611 S	*	8/1998	Huang	.....	D7/679
D398,236 S	*	9/1998	Huang	.....	D9/502
D436,524 S	*	1/2001	Owens	.....	D9/300
D445,334 S	*	7/2001	Bretz et al.	.....	D9/538 X
D451,026 S	*	11/2001	Heisel et al.	.....	D9/502

D455,078 S \* 4/2002 Bretz et al. .... D9/502

**OTHER PUBLICATIONS**

Packaging Catalog, "Glass Finishes for Closures", Date of publication Pre-1975, p. 234, Diagrams furnished by "Glass Container Association of America".\*

\* cited by examiner

*Primary Examiner*—Adir Aronovich

*Assistant Examiner*—Carol Rademaker

(74) *Attorney, Agent, or Firm*—Milbank, Tweed, Hadley & McCloy LLP

(57) **CLAIM**

The ornamental design for a bottle, as shown and described.

**DESCRIPTION**

FIG. 1 is a top perspective view of the bottle of the claimed design;

FIG. 2 is a bottom perspective view thereof;

FIG. 3 is a front elevational view thereof;

FIG. 4 is a right elevational view thereof;

FIG. 5 is a left elevational view thereof;

FIG. 6 is a rear elevational view thereof;

FIG. 7 is a top plan view thereof; and,

FIG. 8 is a bottom plan view thereof.

**1 Claim, 5 Drawing Sheets**

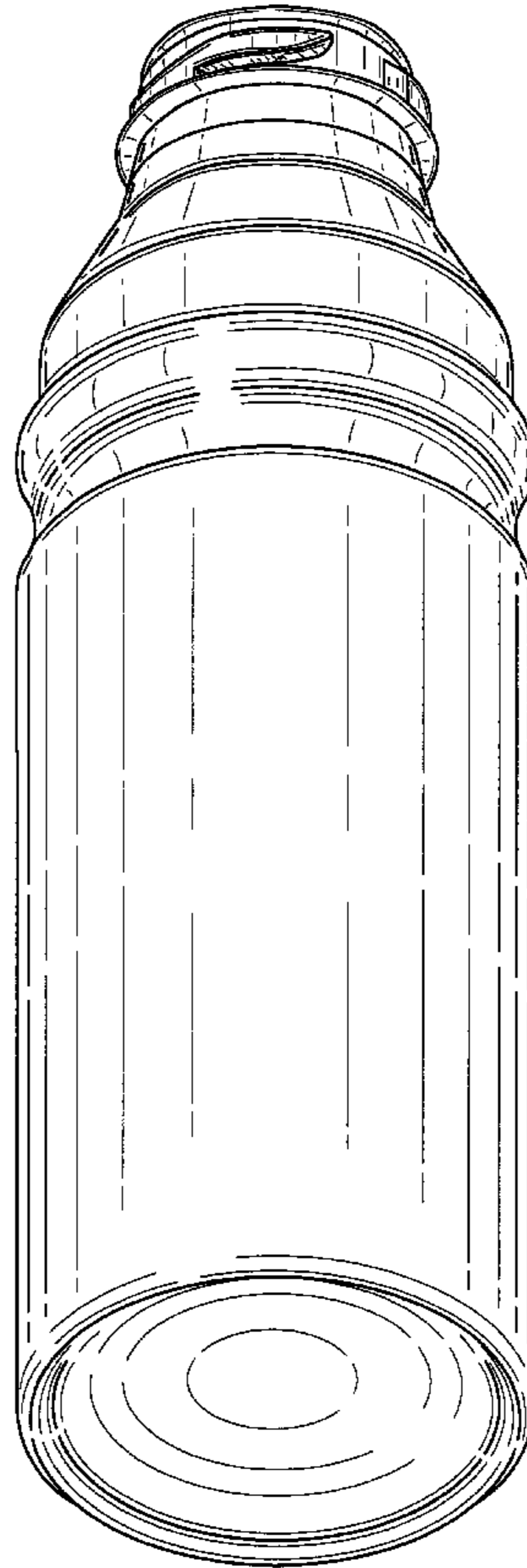
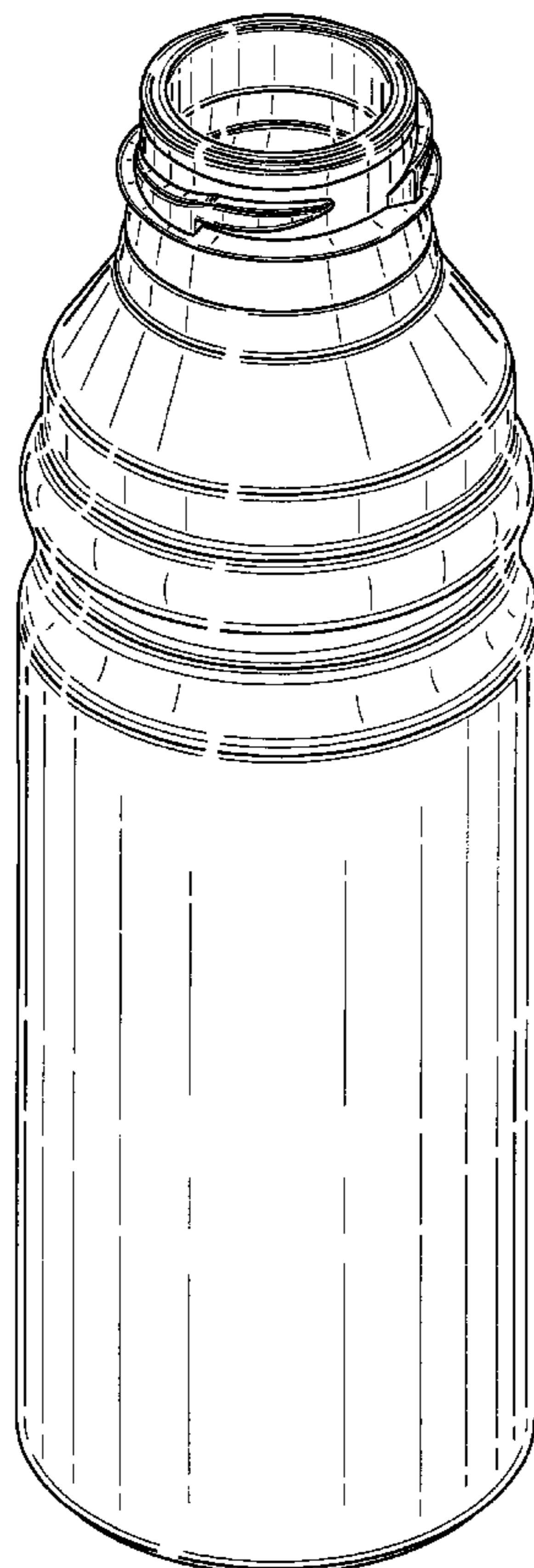

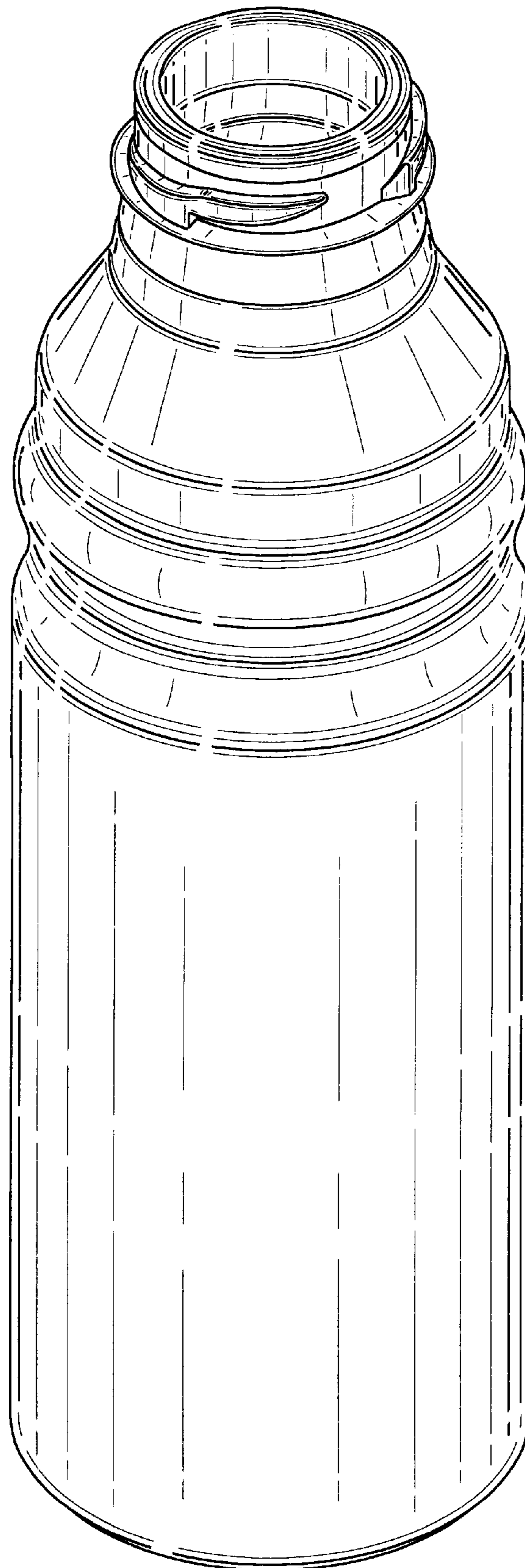

FIG. 1

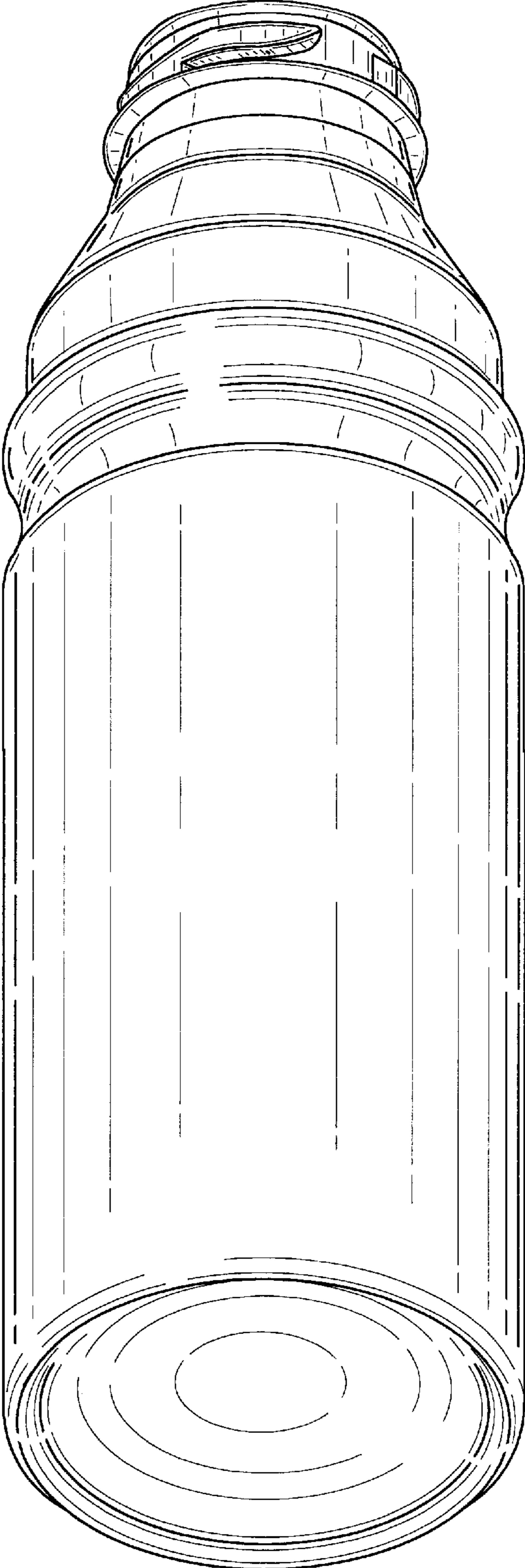

FIG. 2

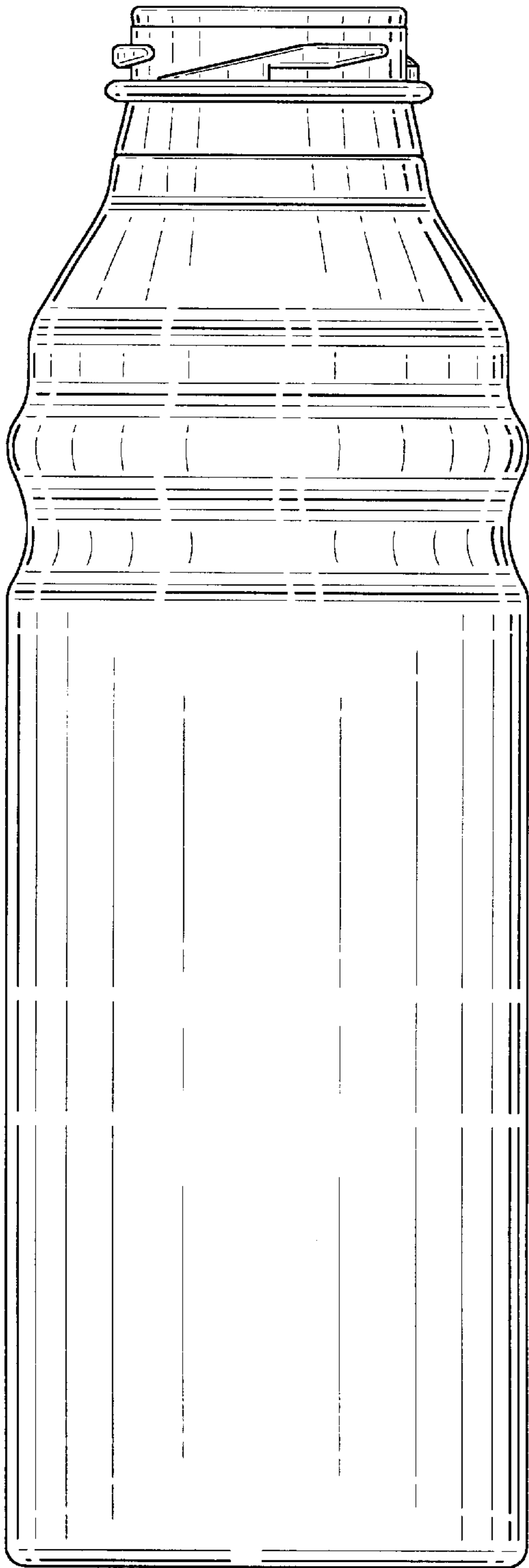

FIG. 3

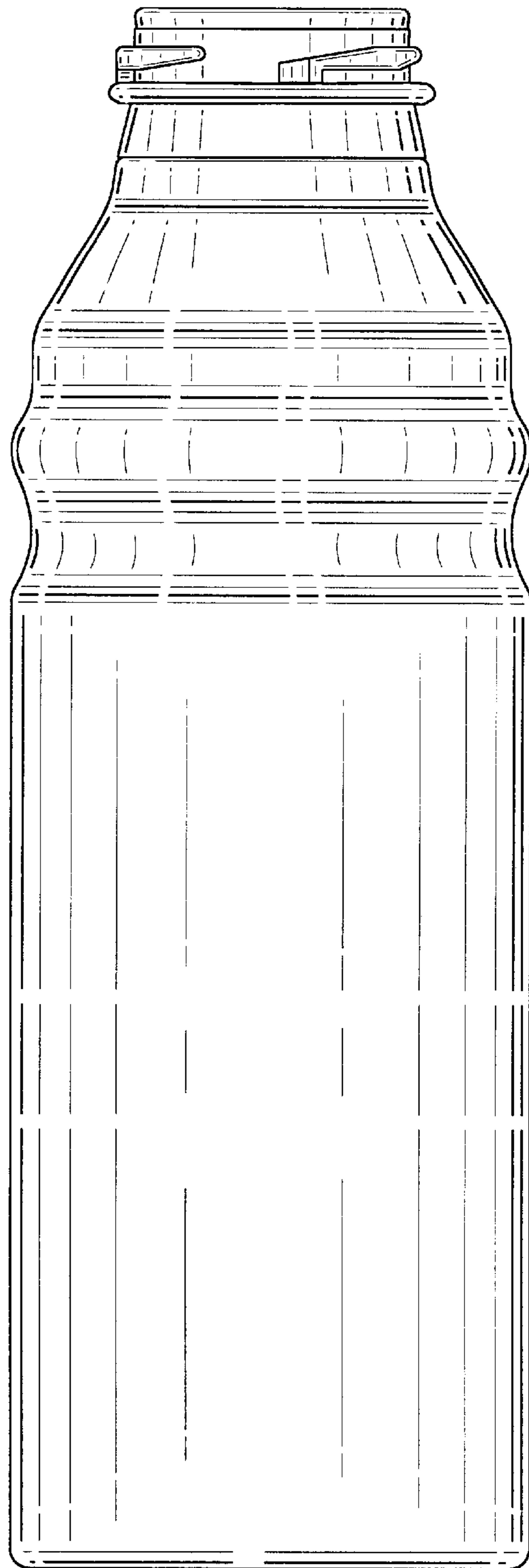

FIG. 4

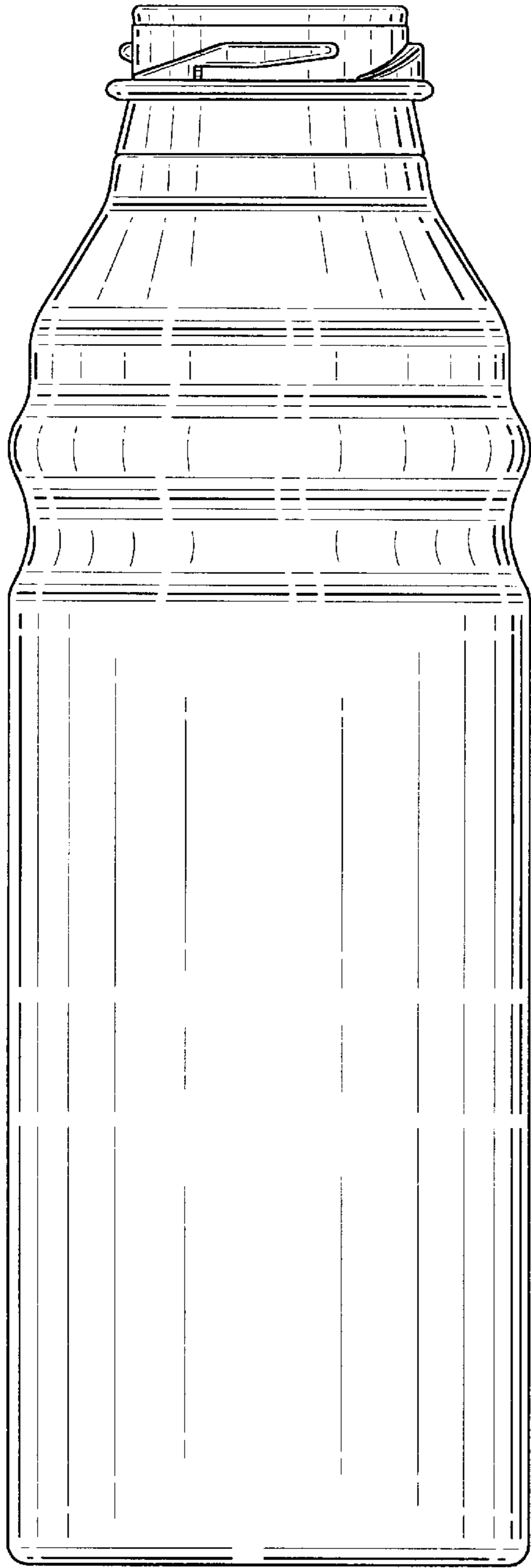

FIG. 5

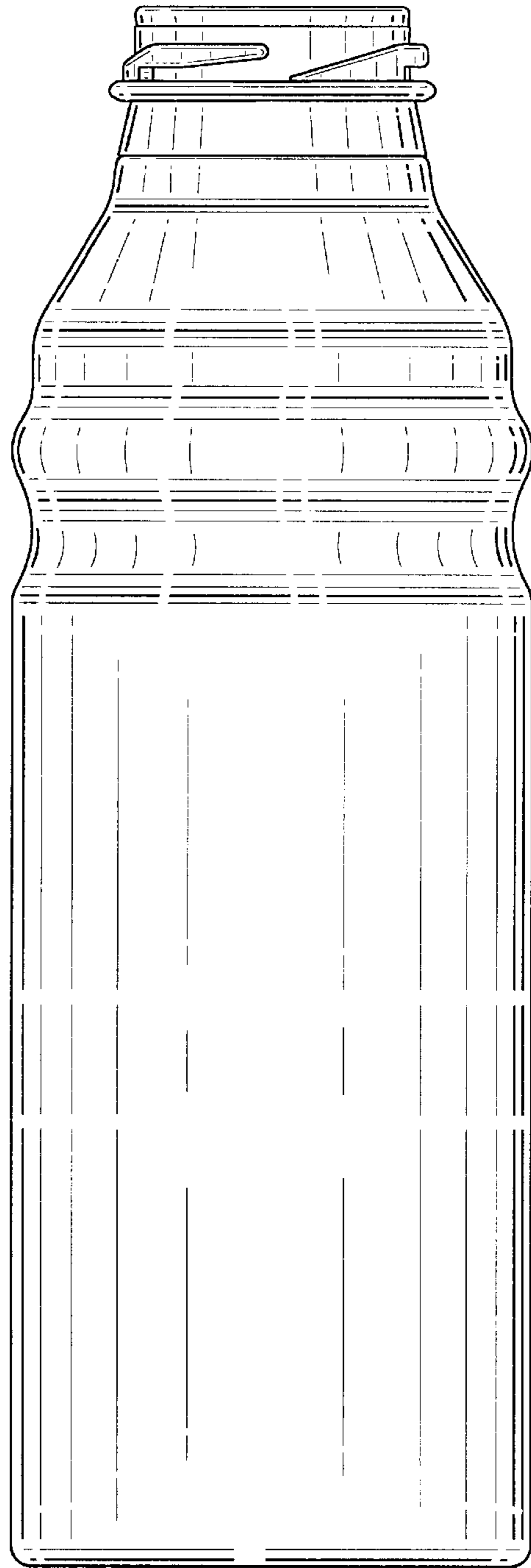

FIG. 6

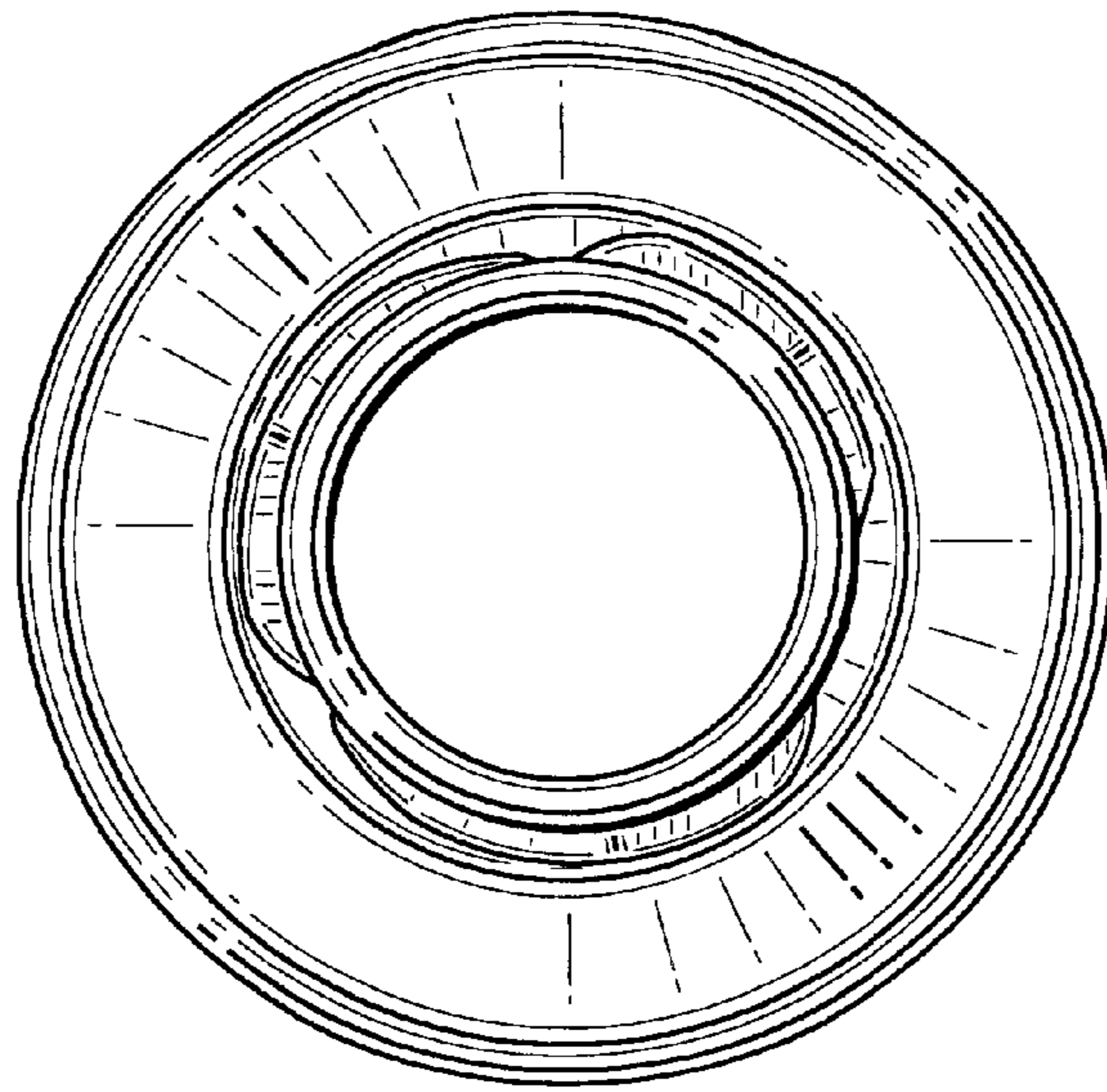

FIG. 7

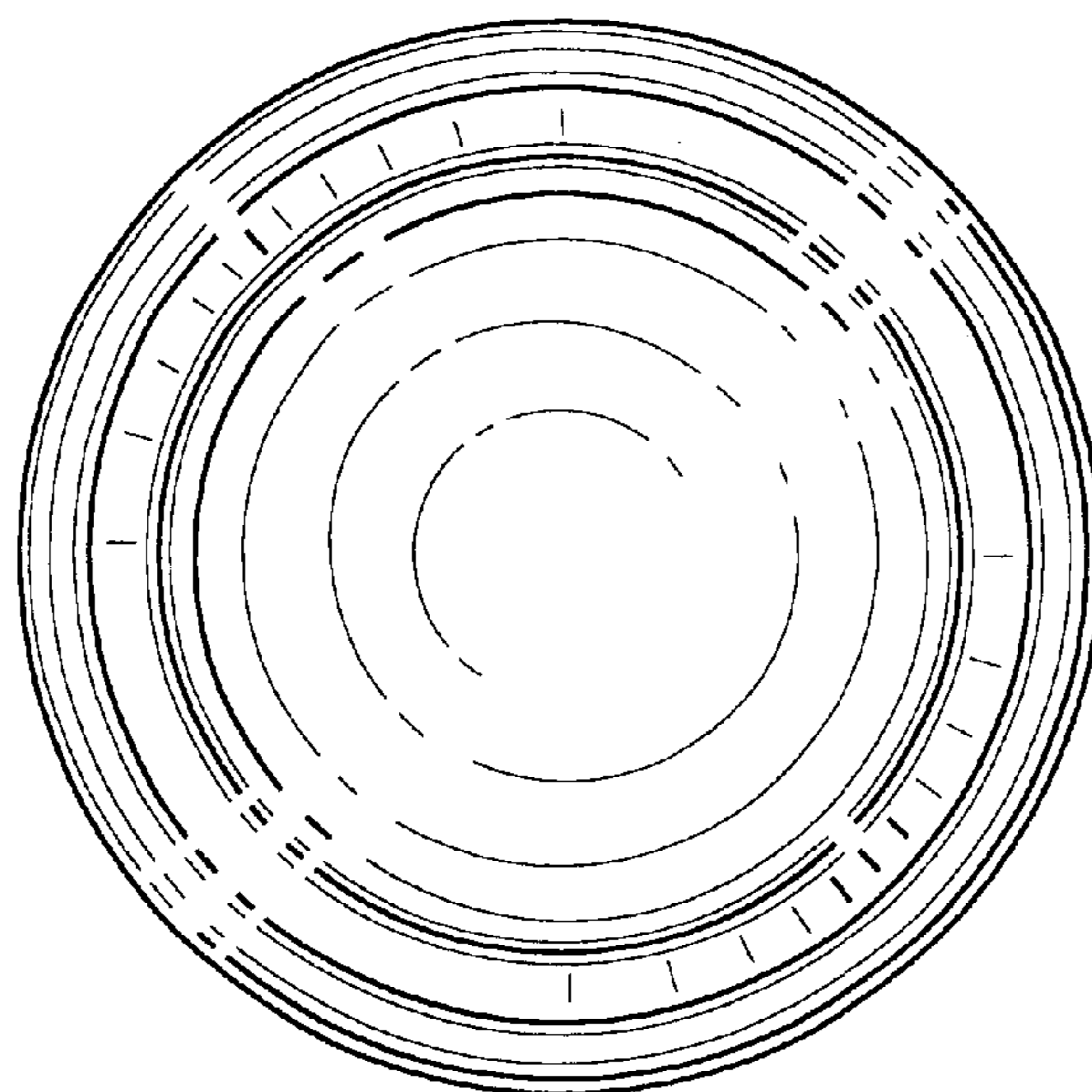

FIG. 8