

US00D493354S1

(12) **United States Design Patent** (10) **Patent No.:** **US D493,354 S**  
**Vito et al.** (45) **Date of Patent:** **\*\* Jul. 27, 2004**

(54) **LOCK ASSEMBLY COMPONENT**

(76) Inventors: **Robert A. Vito**, 1434 Sugartown Rd., Berwyn, PA (US) 19312; **Paul Moreton**, #1, Lane 25 Shlen Bei Jay, Tainan City (TW)

(\*\*) Term: **14 Years**

(21) Appl. No.: **29/172,575**

(22) Filed: **Dec. 12, 2002**

**Related U.S. Application Data**

(63) Continuation-in-part of application No. 10/052,211, filed on Oct. 19, 2001.

(51) **LOC (7) Cl.** ..... **08-07**

(52) **U.S. Cl.** ..... **D8/343; D8/499**

(58) **Field of Search** ..... D8/330, 331, 343, D8/344, 349; 70/57.1, 207-211, 224, 233, 237, 238, 225, 226, 14, 17-19

(56) **References Cited**

**U.S. PATENT DOCUMENTS**

1,364,068 A	1/1921	Bader	
1,400,415 A	12/1921	Callahan	
1,428,649 A	9/1922	Miller	
2,716,336 A	8/1955	Ross	
3,190,090 A	6/1965	Zaidener	
3,401,543 A	9/1968	Lewis	
3,690,131 A	9/1972	Davis	
3,898,823 A	8/1975	Ludeman	
4,008,590 A	2/1977	Berkowitz et al.	
4,696,172 A	9/1987	Farrow	
4,699,238 A	10/1987	Tamir	
4,738,127 A	* 4/1988	Johnson	70/209

(List continued on next page.)

*Primary Examiner*—Prabhakar Deshmukh  
(74) *Attorney, Agent, or Firm*—Volpe and Koenig, P.C.

(57) **CLAIM**

We claim the ornamental design for a lock assembly component, as shown and described.

**DESCRIPTION**

FIG. 1 is a perspective view of a lock assembly component according to a first preferred embodiment of our new design; FIG. 2 is a second perspective view of the lock assembly component of FIG. 1; FIG. 3 is a left side elevational view of the lock assembly component of FIG. 1; FIG. 4 is a right side elevational view of the lock assembly component of FIG. 1; FIG. 5 is a front elevational view of the lock assembly component of FIG. 1; FIG. 6 is a rear elevational view of the lock assembly component of FIG. 1; FIG. 7 is a top plan view of the lock assembly component of FIG. 1; FIG. 8 is a bottom plan view of the lock assembly component of FIG. 1; FIG. 9 is a perspective view of a lock assembly component according to a second preferred embodiment of our new design; FIG. 10 is a second perspective view of the lock assembly component of FIG. 9; FIG. 11 is a left side elevational view of the lock assembly component of FIG. 9; FIG. 12 is a right side elevational view of the lock assembly component of FIG. 9; FIG. 13 is a front elevational view of the lock assembly component of FIG. 9; FIG. 14 is a rear elevational view of the lock assembly component of FIG. 9; FIG. 15 is a top plan view of the lock assembly component of FIG. 9; and, FIG. 16 is a bottom plan view of the lock assembly component of FIG. 9. The dashed lines in FIGS. 1-16 represent environment and are for illustrative purposes only and do not constitute part of the claimed design. The phantom lines in FIGS. 1-16 define the border between claimed and unclaimed matter.

**1 Claim, 8 Drawing Sheets**

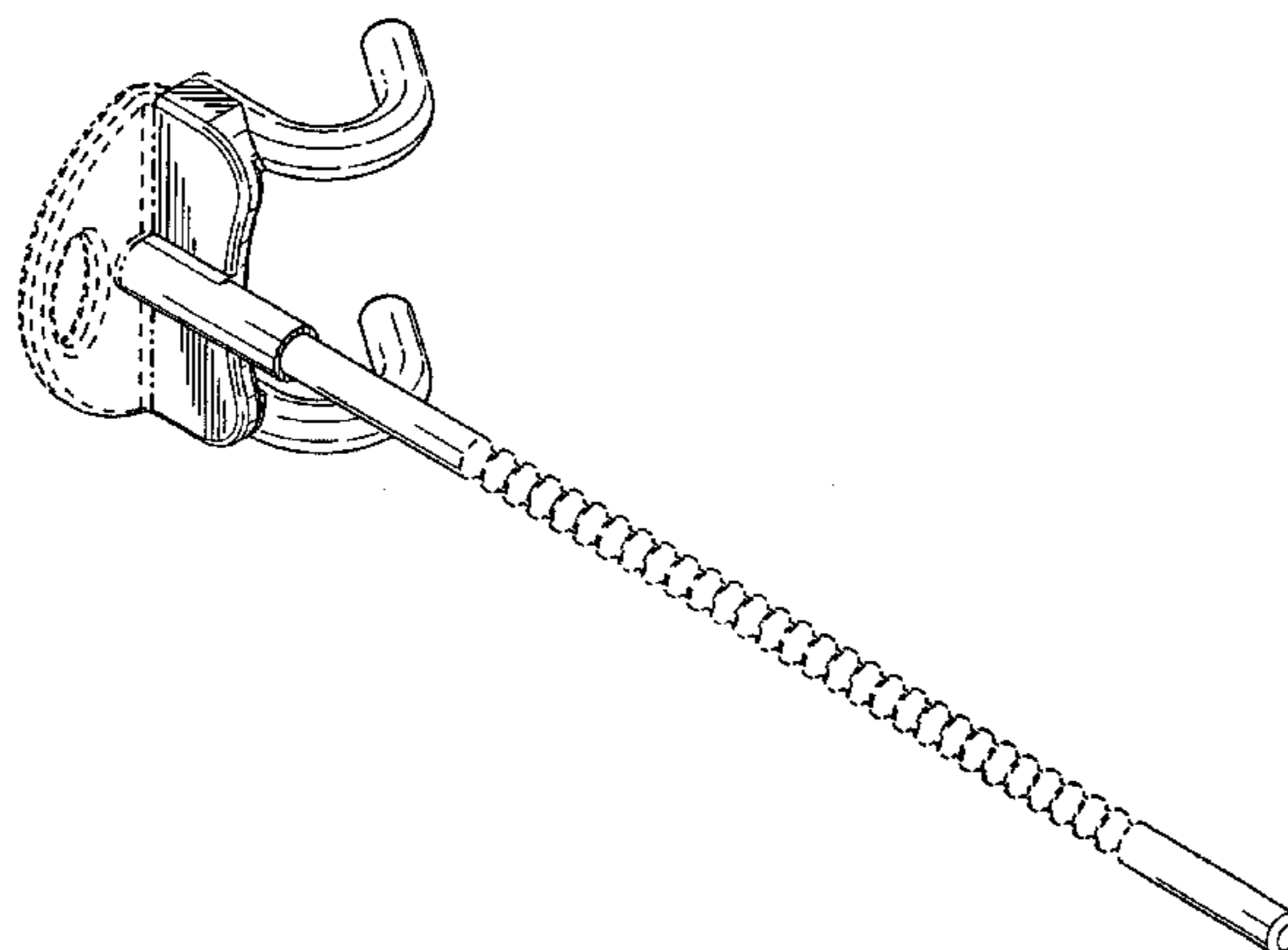

# US D493,354 S

Page 2

## U.S. PATENT DOCUMENTS

4,779,435 A	10/1988	Farrow		5,709,113 A	1/1998	Godfrey	
D306,252 S	*	2/1990 Johnson	D8/331	D391,142 S	2/1998	Winner	
4,935,047 A	*	6/1990 Wu	70/238	5,730,008 A	3/1998	Case et al.	
5,092,146 A	*	3/1992 Wang	70/226	5,735,149 A	4/1998	Winner, Jr.	
5,113,674 A		5/1992 LiCausi		5,755,123 A	5/1998	Winner, Jr.	
5,119,651 A		6/1992 Yang		5,765,415 A	6/1998	Savinsky	
D330,844 S		11/1992 Chang		5,778,709 A	7/1998	Hsu	
5,222,381 A	*	6/1993 Wilcox	70/19	D398,830 S	9/1998	Winner	
D339,973 S	*	10/1993 Chen	D8/331	5,826,448 A	10/1998	Graham	
5,259,222 A		11/1993 Jang		5,836,186 A	11/1998	Winner, Jr.	
5,267,458 A		12/1993 Heh		5,842,361 A	12/1998	Banez	
5,275,030 A		1/1994 Cole		5,855,128 A	1/1999	Voiculescu	
5,299,438 A		4/1994 Chen		5,865,044 A	2/1999	Wu	
D348,824 S	*	7/1994 Hsu	D8/331	5,870,912 A	2/1999	Vito	
5,329,793 A		7/1994 Chen		5,881,587 A	3/1999	Vito	
D355,581 S	*	2/1995 Zane et al.	D8/331	5,887,464 A	3/1999	Perez	
5,461,891 A		10/1995 Noel		5,901,586 A	5/1999	Hale	
5,488,844 A		2/1996 Winner		5,906,121 A	5/1999	Mankarious	
D369,738 S		5/1996 Hull et al.		5,921,115 A	7/1999	Winner	
D369,951 S	*	5/1996 Crittenden	D8/331	D412,826 S	8/1999	Calpito	
5,513,506 A		5/1996 Ricalde		5,953,941 A	* 9/1999	Freund	70/209
D372,418 S		8/1996 Winner		5,996,721 A	12/1999	Winner	
5,566,560 A		10/1996 LiCausi		6,029,483 A	2/2000	Daniels	
5,598,142 A		1/1997 Winner, Jr.		6,089,055 A	7/2000	Vito	
5,600,979 A		2/1997 Winner et al.		6,116,065 A	9/2000	Hale	
5,604,384 A		2/1997 Carlo et al.		D432,390 S	10/2000	Geringer et al.	
5,613,383 A		3/1997 Banez		6,131,426 A	10/2000	Tarnofsky	
5,635,899 A		6/1997 Carlo et al.		6,192,724 B1	2/2001	Vito	
D380,662 S	*	7/1997 Sage	D8/343	6,202,456 B1	3/2001	Vickers	
5,653,133 A		8/1997 Passantino		6,212,920 B1	4/2001	Winner	
D383,372 S		9/1997 Winner		6,223,568 B1	5/2001	Wu	
5,671,620 A		9/1997 Carvey et al.		6,223,569 B1	5/2001	Wu	
5,673,575 A		10/1997 Carlo et al.		6,230,527 B1	5/2001	Wu	
5,677,668 A		10/1997 Winner, Jr.		6,240,753 B1	6/2001	Wu	
5,704,233 A		1/1998 Farshad					

\* cited by examiner

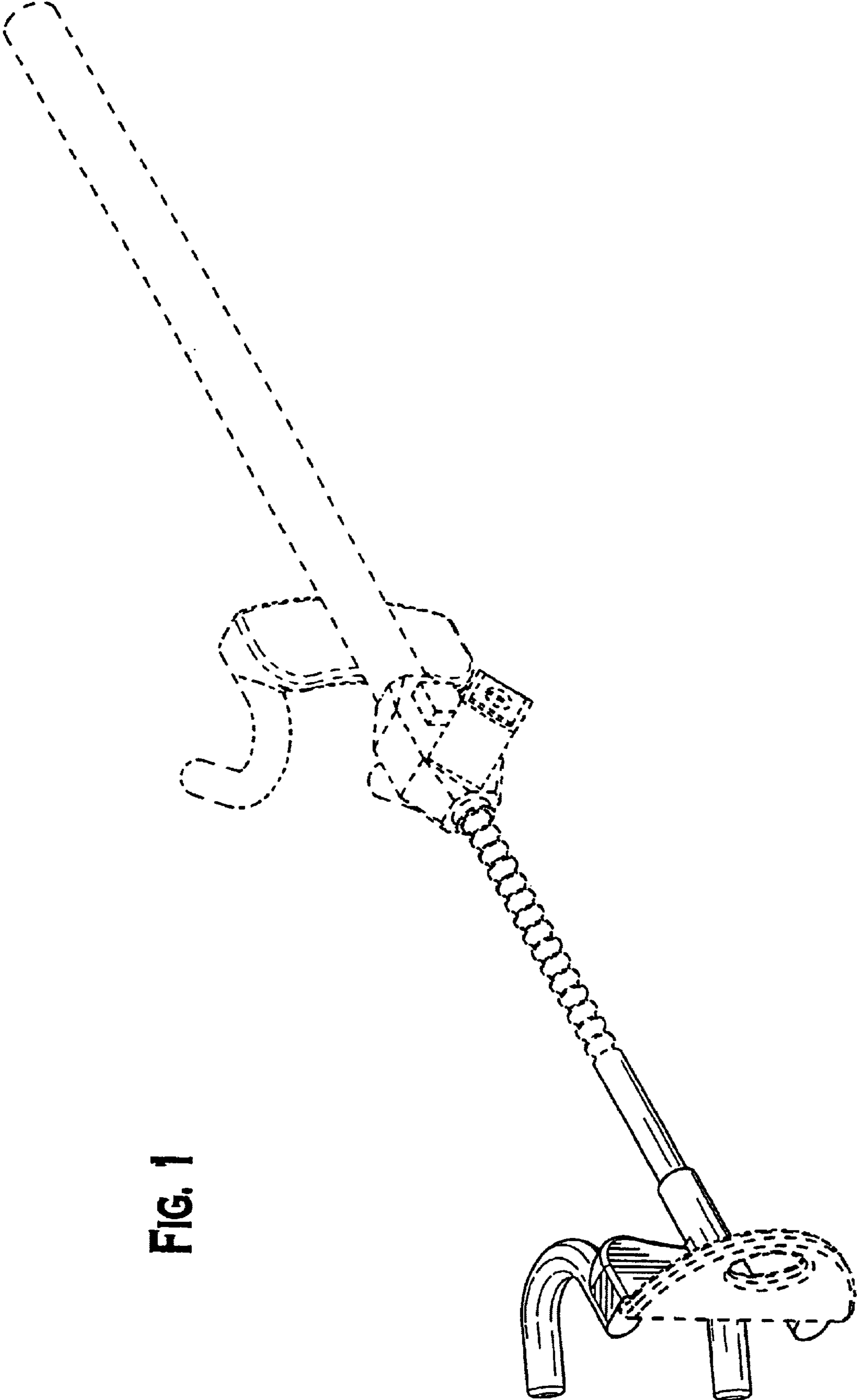

FIG. 1

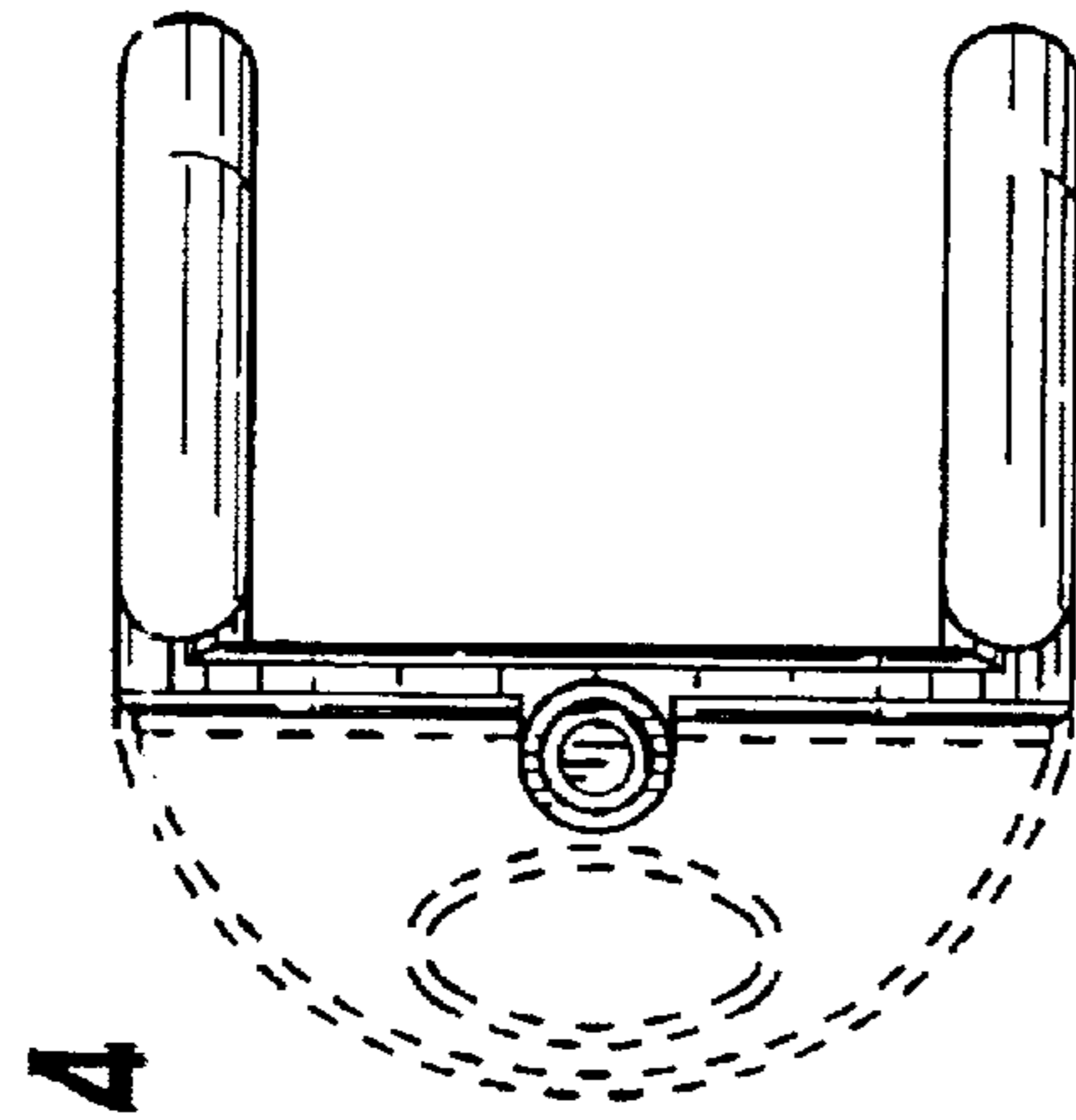

FIG. 4

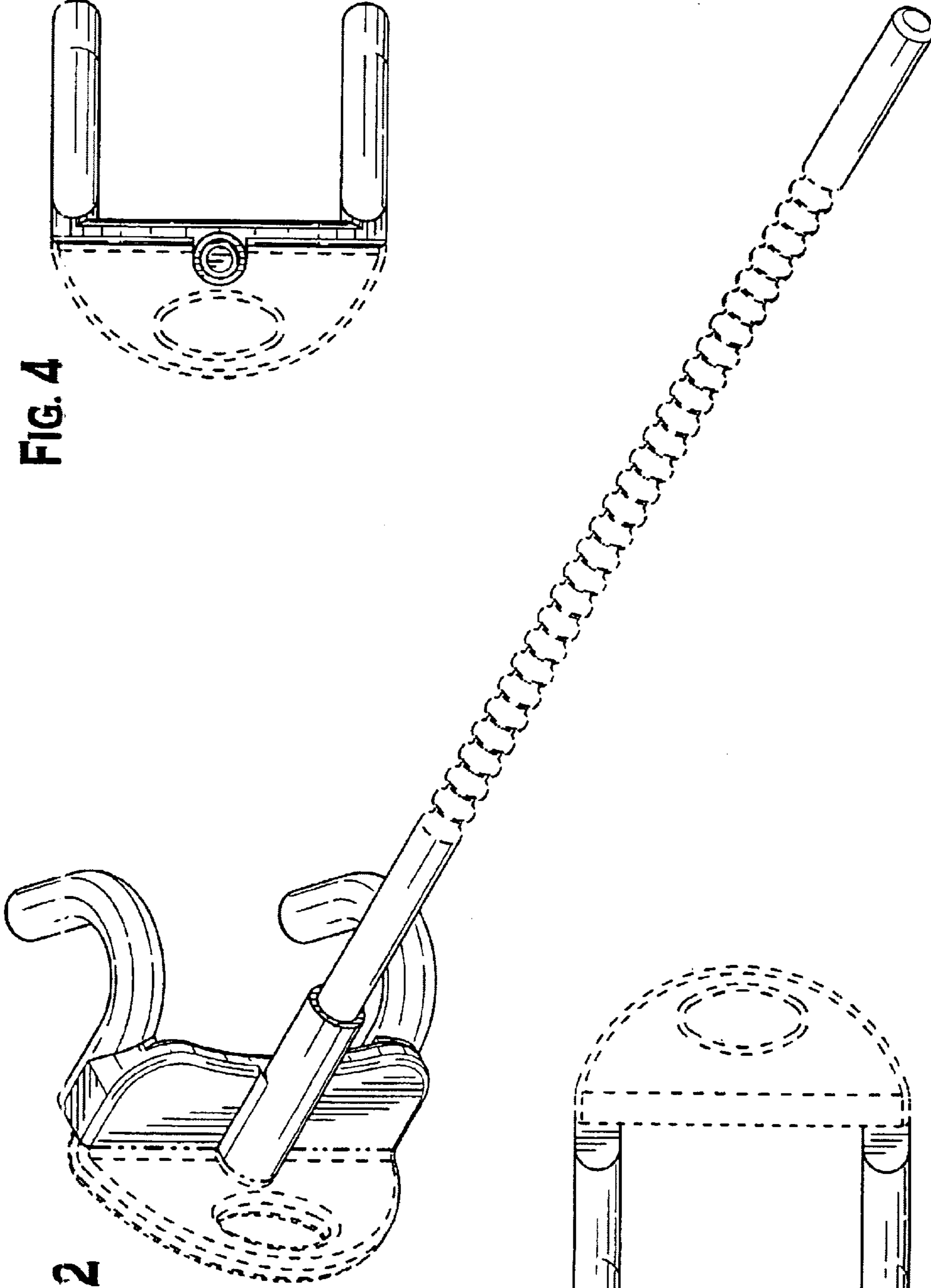

FIG. 2

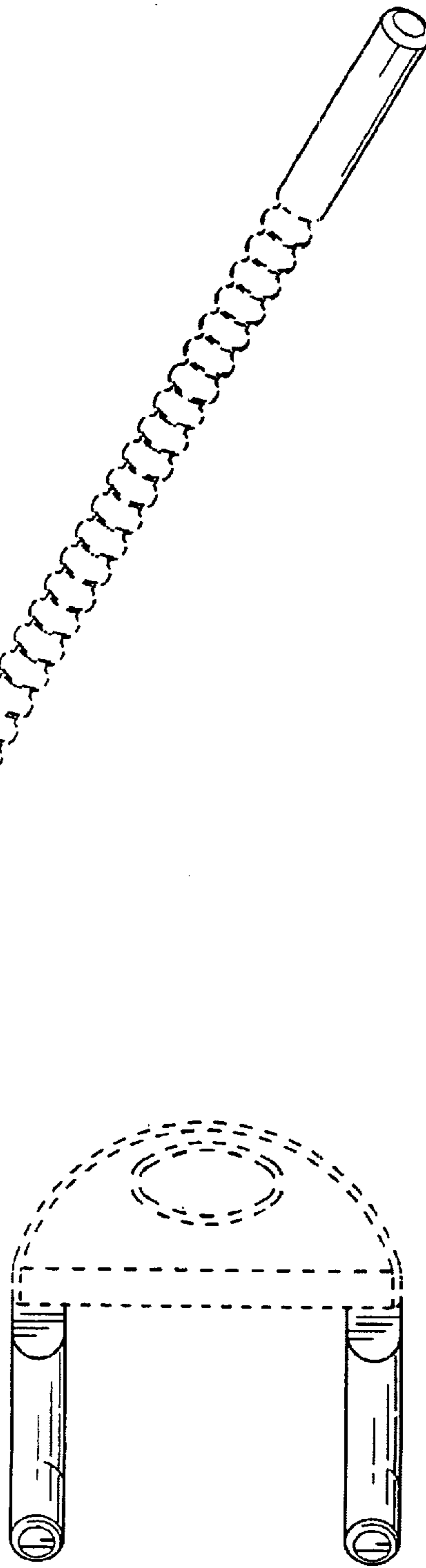
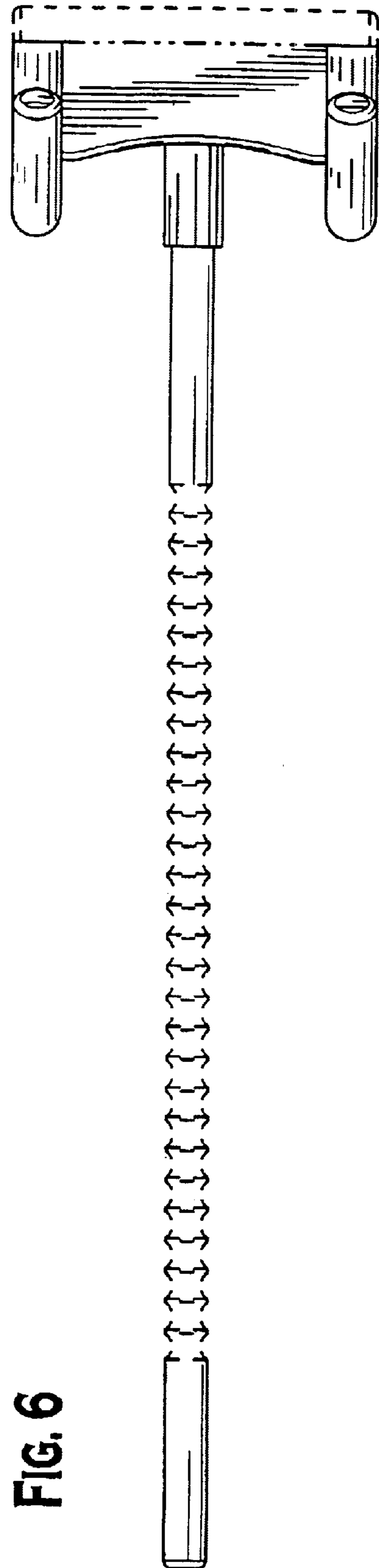
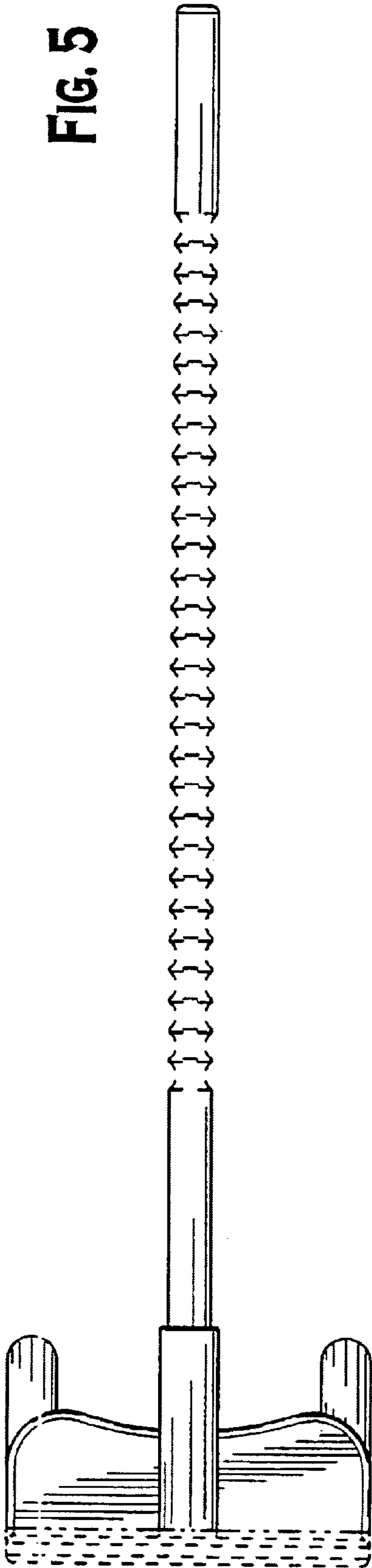

FIG. 3

**FIG. 5**



**FIG. 6**

FIG. 7

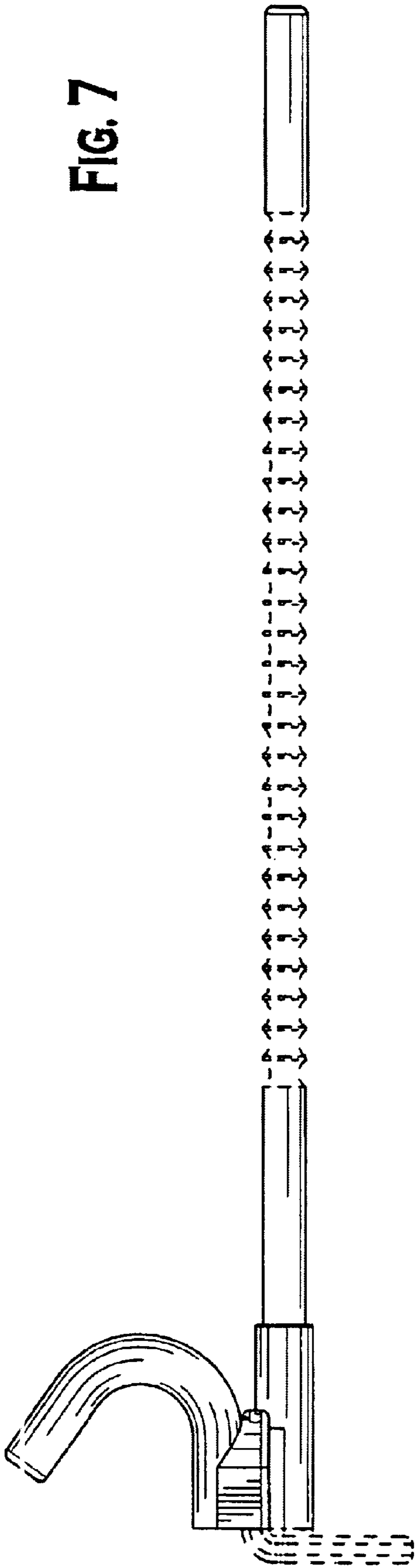
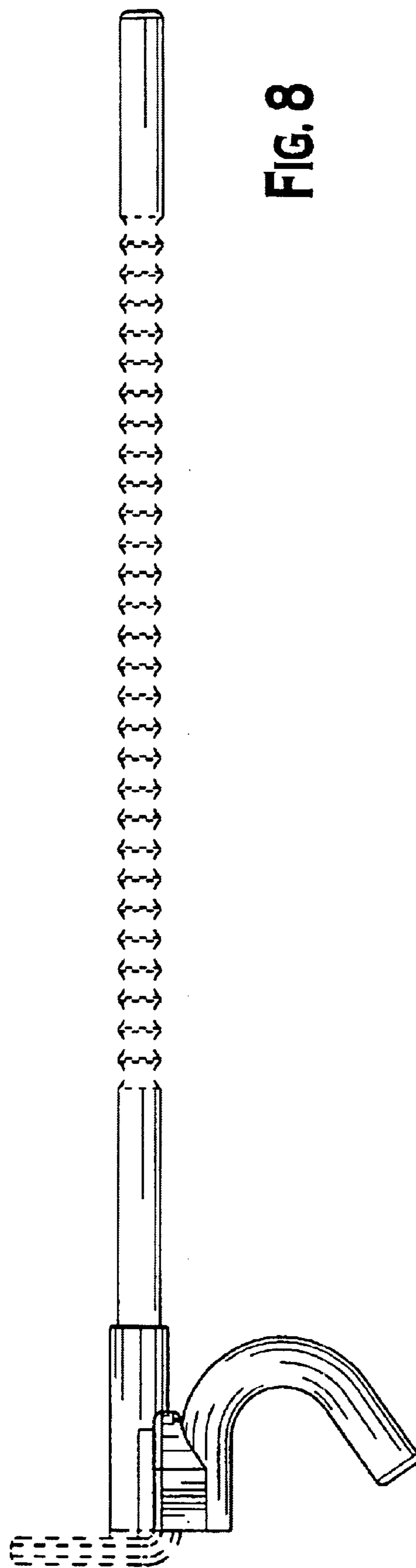

FIG. 8



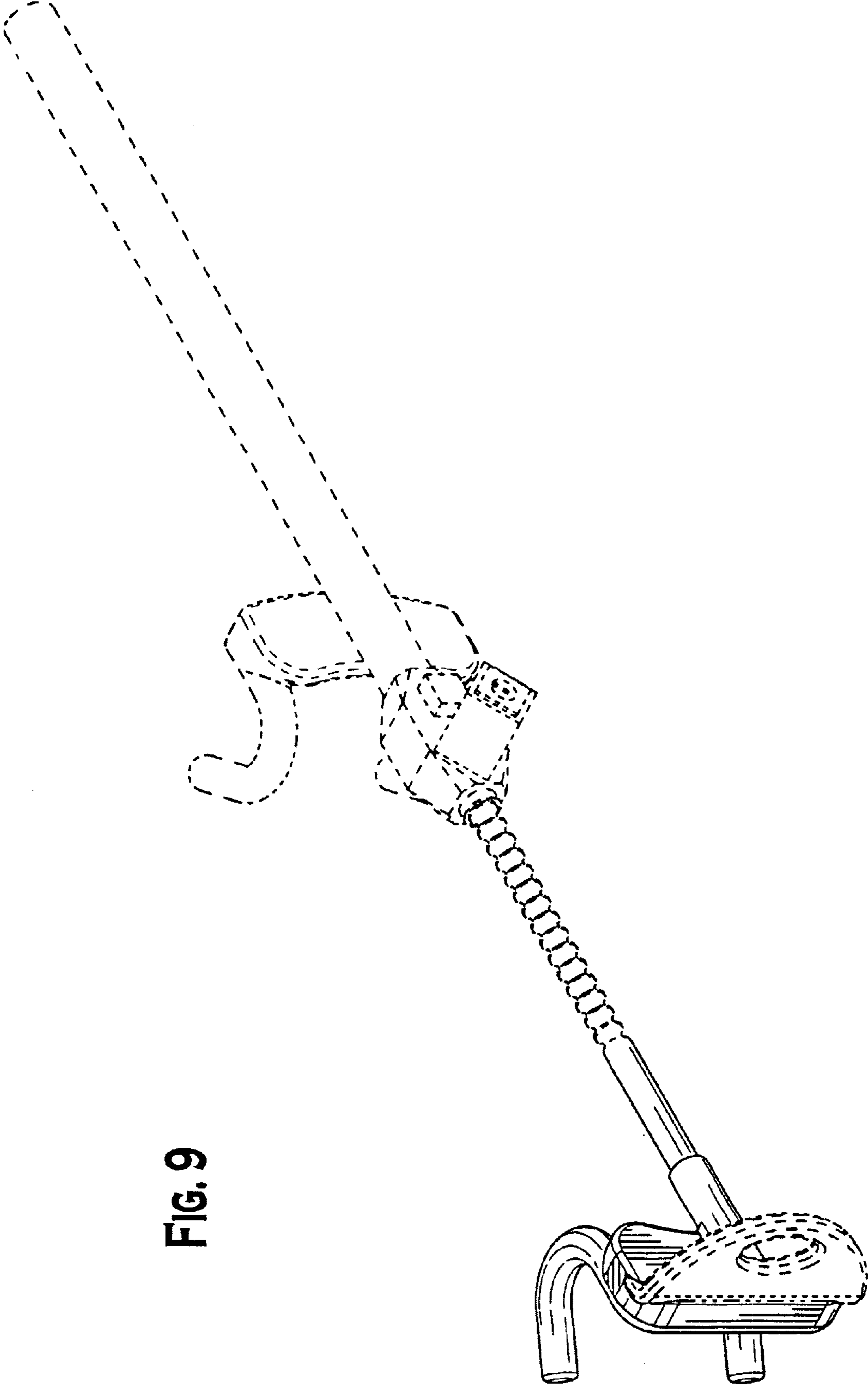

FIG. 9

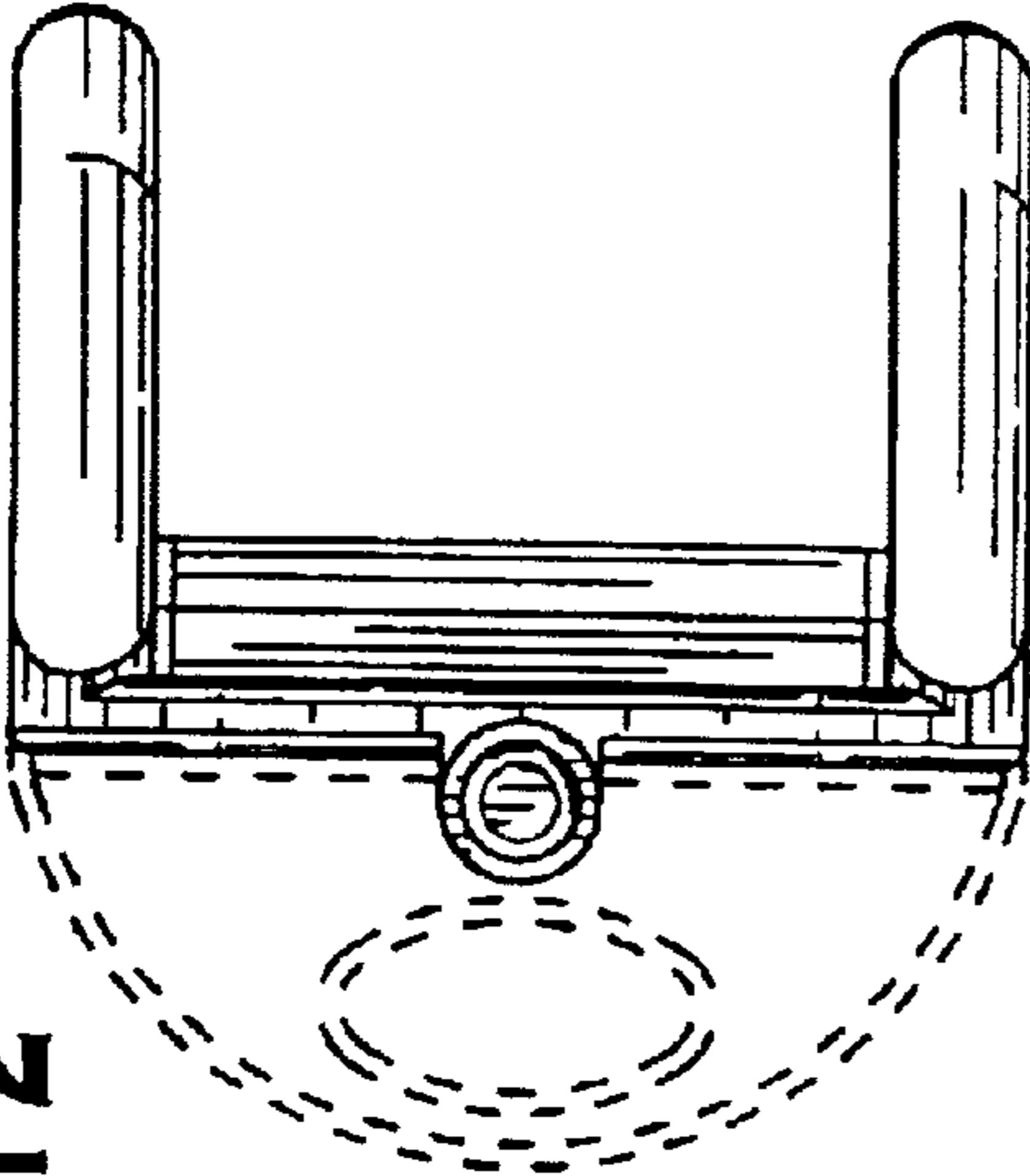

FIG. 12

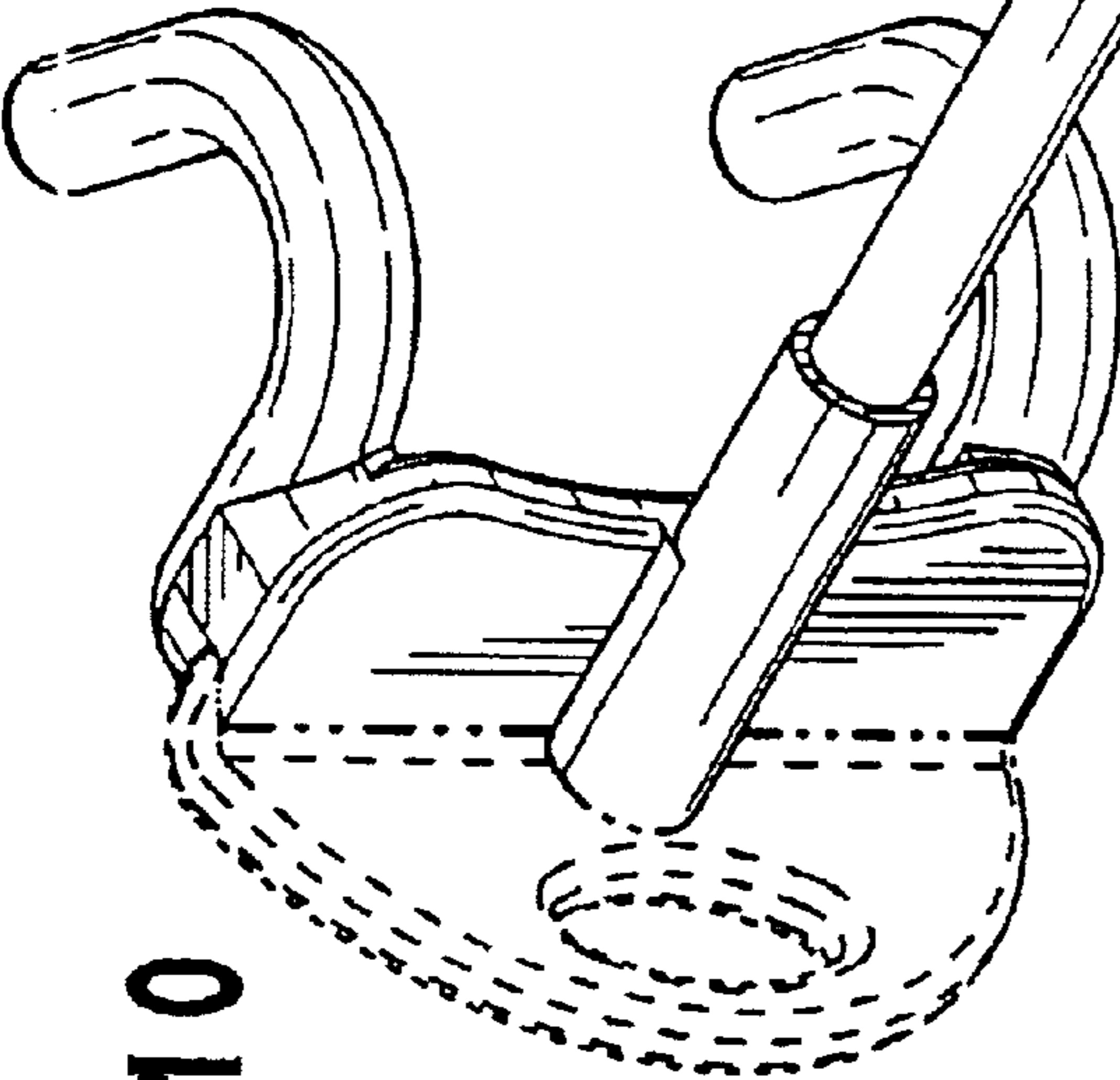

FIG. 10

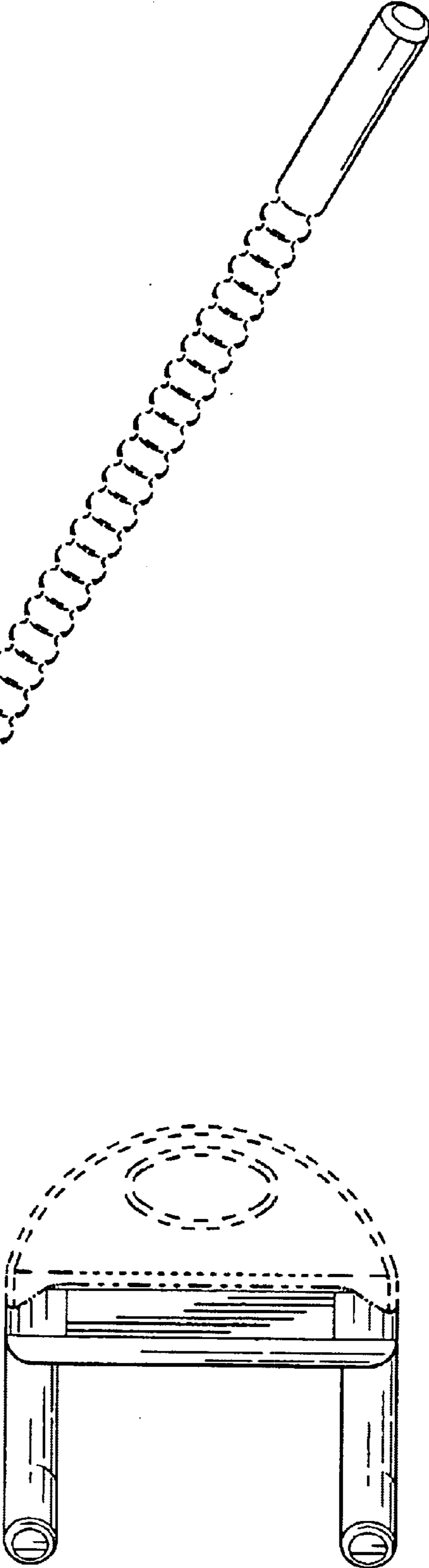
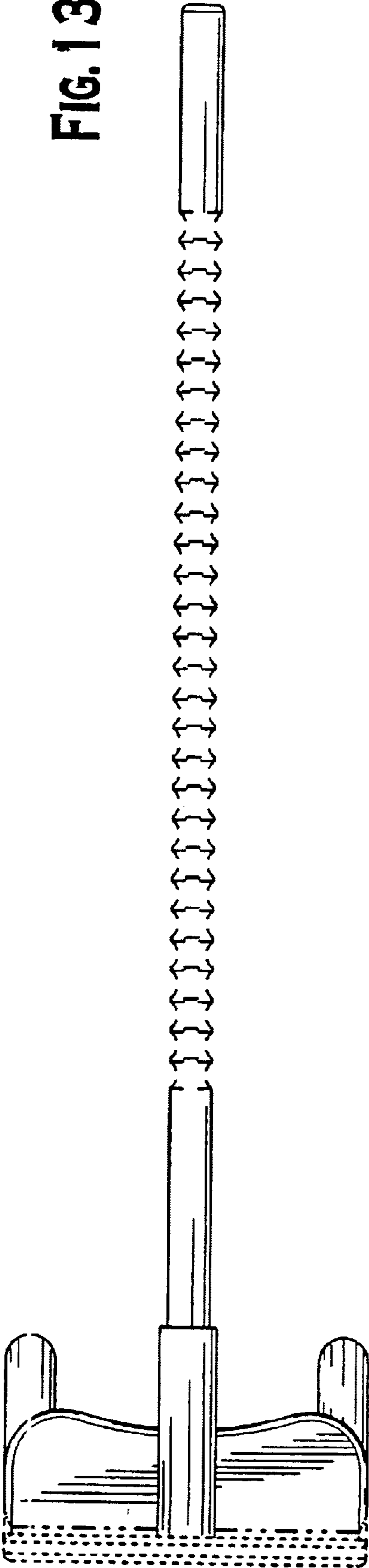

FIG. 11



**FIG. 13**



**FIG. 14**

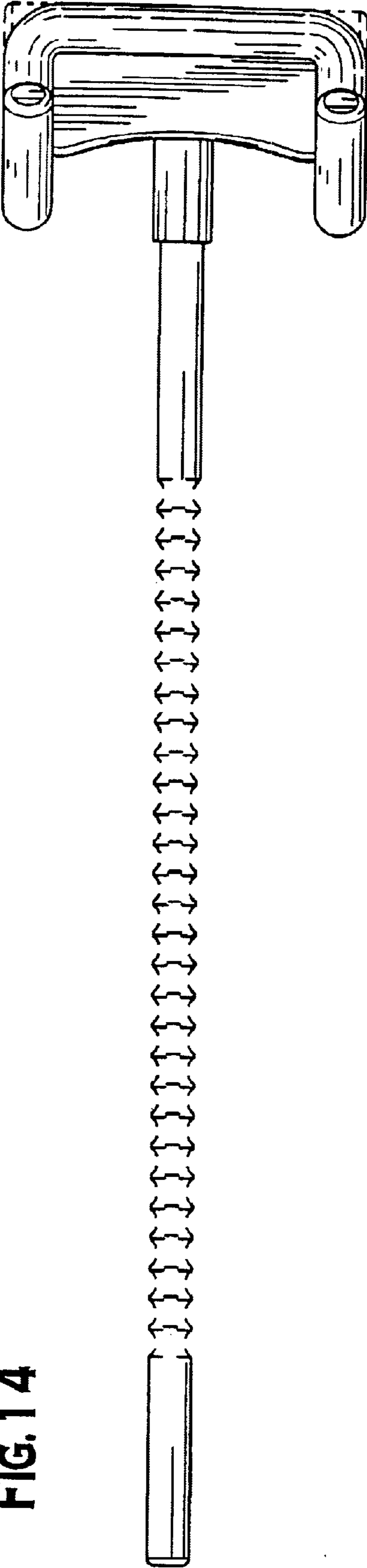

FIG. 15

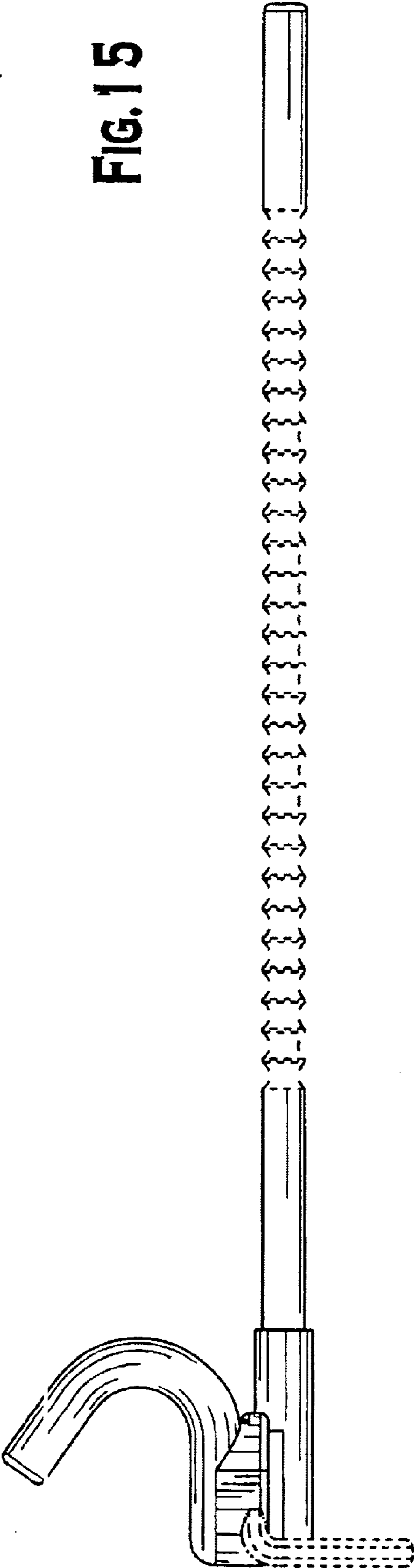

FIG. 16

