

US00D493194S1

(12) **United States Design Patent**
Ohashi et al.

(10) **Patent No.: US D493,194 S**
(45) **Date of Patent: ** Jul. 20, 2004**

- (54) **PRINTING HEAD FOR PRINTER**
- (75) Inventors: **Tetsuya Ohashi, Matsudo (JP); Kenji Kitabatake, Kawasaki (JP); Keisuke Matsuo, Yokohama (JP); Hiroki Hayashi, Yokohama (JP); Yasuo Kotaki, Yokohama (JP)**
- (73) Assignee: **Canon Kabushiki Kaisha, Tokyo (JP)**
- (**) Term: **14 Years**
- (21) Appl. No.: **29/178,486**
- (22) Filed: **Mar. 28, 2003**
- (30) **Foreign Application Priority Data**
Sep. 30, 2002 (JP) 2002-026668
- (51) **LOC (7) Cl. 18-02**
- (52) **U.S. Cl. D18/56; 347/86**
- (58) **Field of Search D18/40, 43, 56; 347/86, 87**

- D382,014 S * 8/1997 Tashiro et al. D18/56
- 5,831,652 A * 11/1998 Hinami et al. 347/86
- 6,050,667 A * 4/2000 Yamada 347/86
- D438,242 S * 2/2001 Chiba et al. D18/56
- D443,892 S * 6/2001 Sekine et al. D18/56
- 6,302,535 B1 * 10/2001 Sturgeon et al. 347/86
- D466,926 S 12/2002 Miyahara et al. D18/56
- D476,360 S * 6/2003 Kawamura et al. D18/56

* cited by examiner

Primary Examiner—Cathy Anne MacCormac
(74) *Attorney, Agent, or Firm*—Fitzpatrick, Cella, Harper & Scinto

(57) **CLAIM**

The ornamental design for a printing head for printer, as shown and described.

DESCRIPTION

FIG. 1 is a front view of a printing head for printer showing our new design;
FIG. 2 is a rear view thereof;
FIG. 3 is a top plan view thereof;
FIG. 4 is a bottom plan view thereof;
FIG. 5 is a left side view thereof;
FIG. 6 is a right side view thereof; and,
FIG. 7 is a perspective view thereof as viewed from rear and top.

1 Claim, 5 Drawing Sheets

(56) **References Cited**

U.S. PATENT DOCUMENTS

- 4,530,611 A * 7/1985 Borcenk et al. 347/86
- D371,804 S 7/1996 Kotaki et al. D18/56
- 5,619,237 A * 4/1997 Inoue et al. 347/86
- D382,013 S * 8/1997 Tashiro et al. D18/56

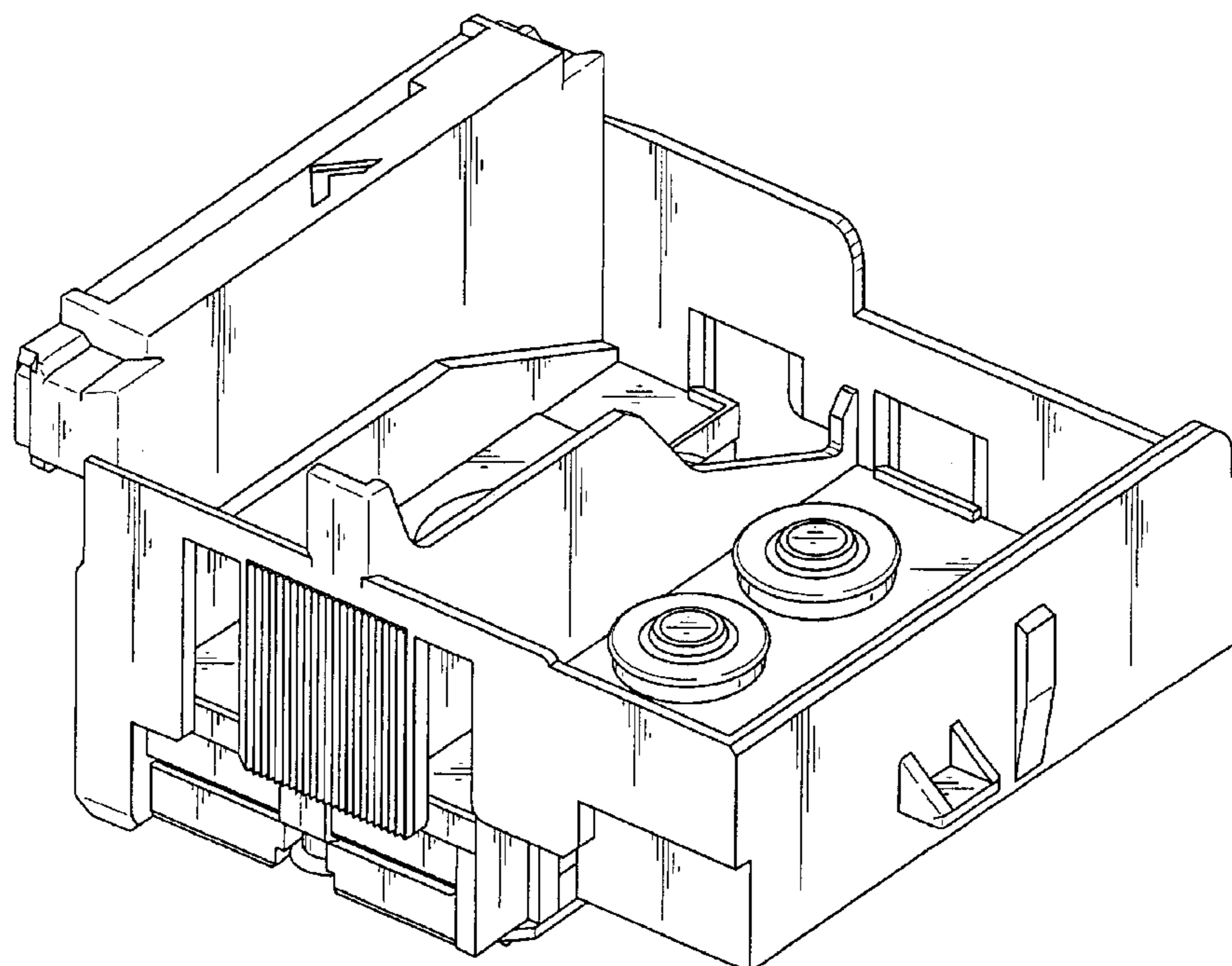

FIG. 1

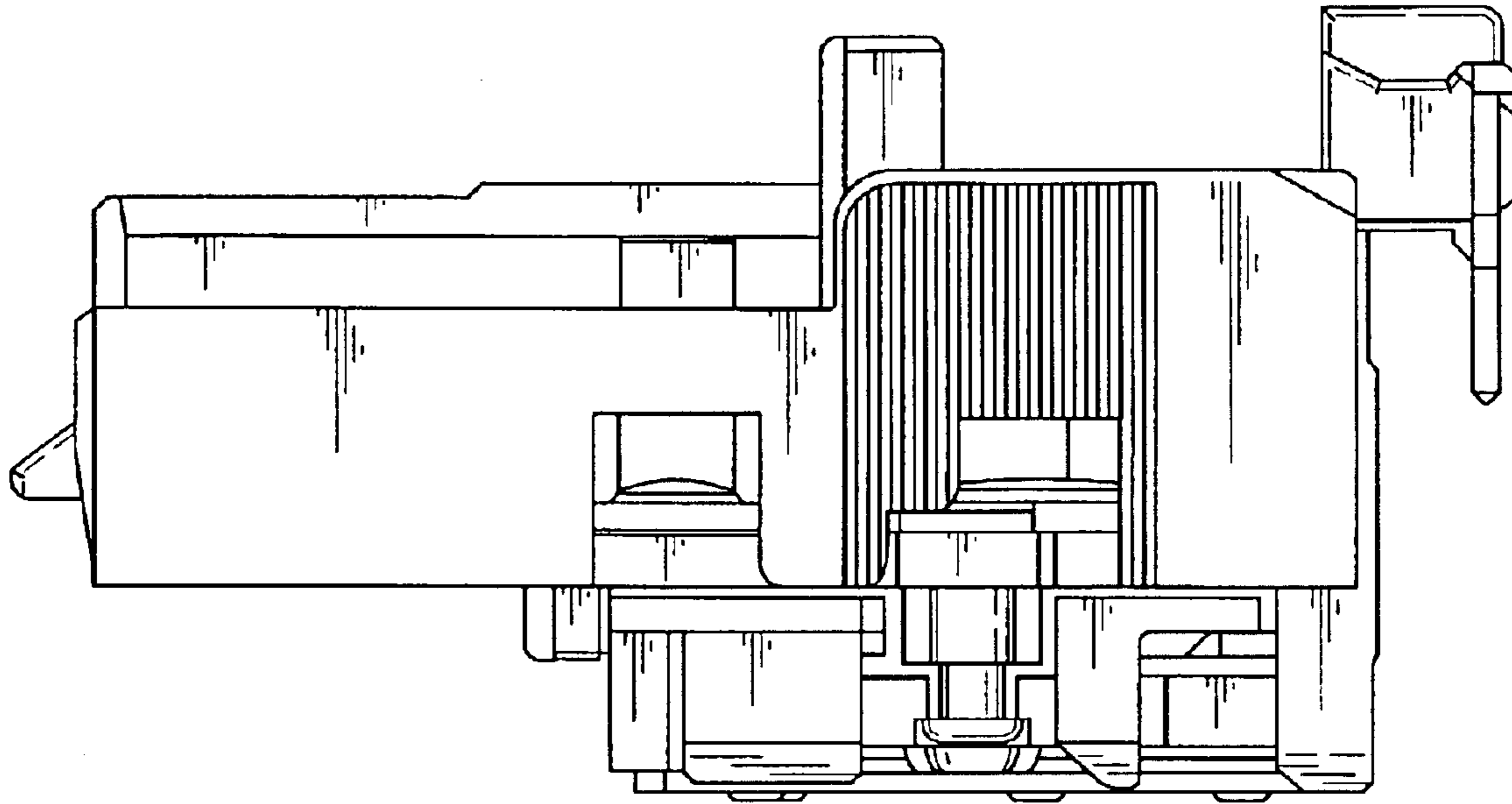

FIG. 2

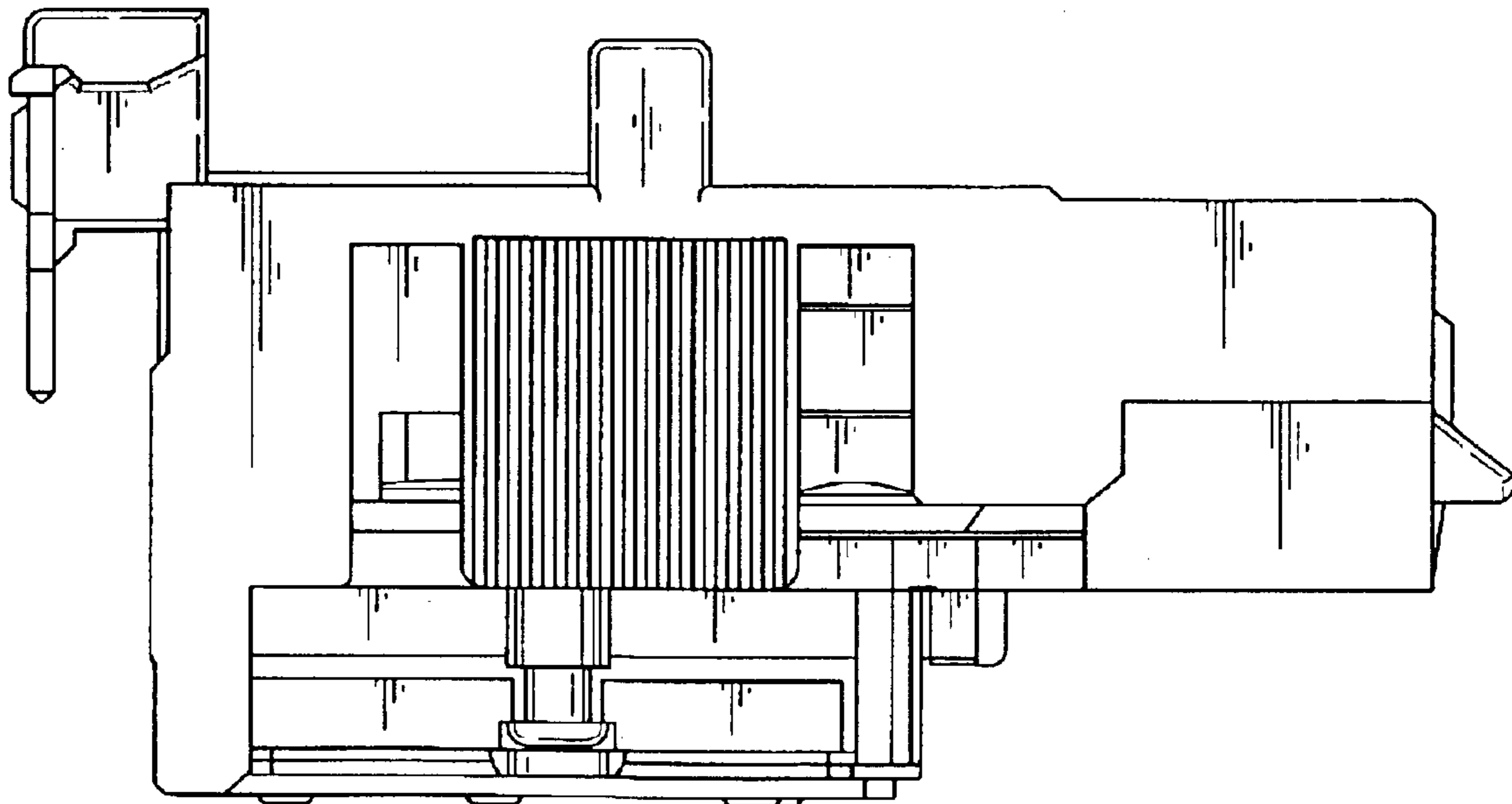

FIG. 3

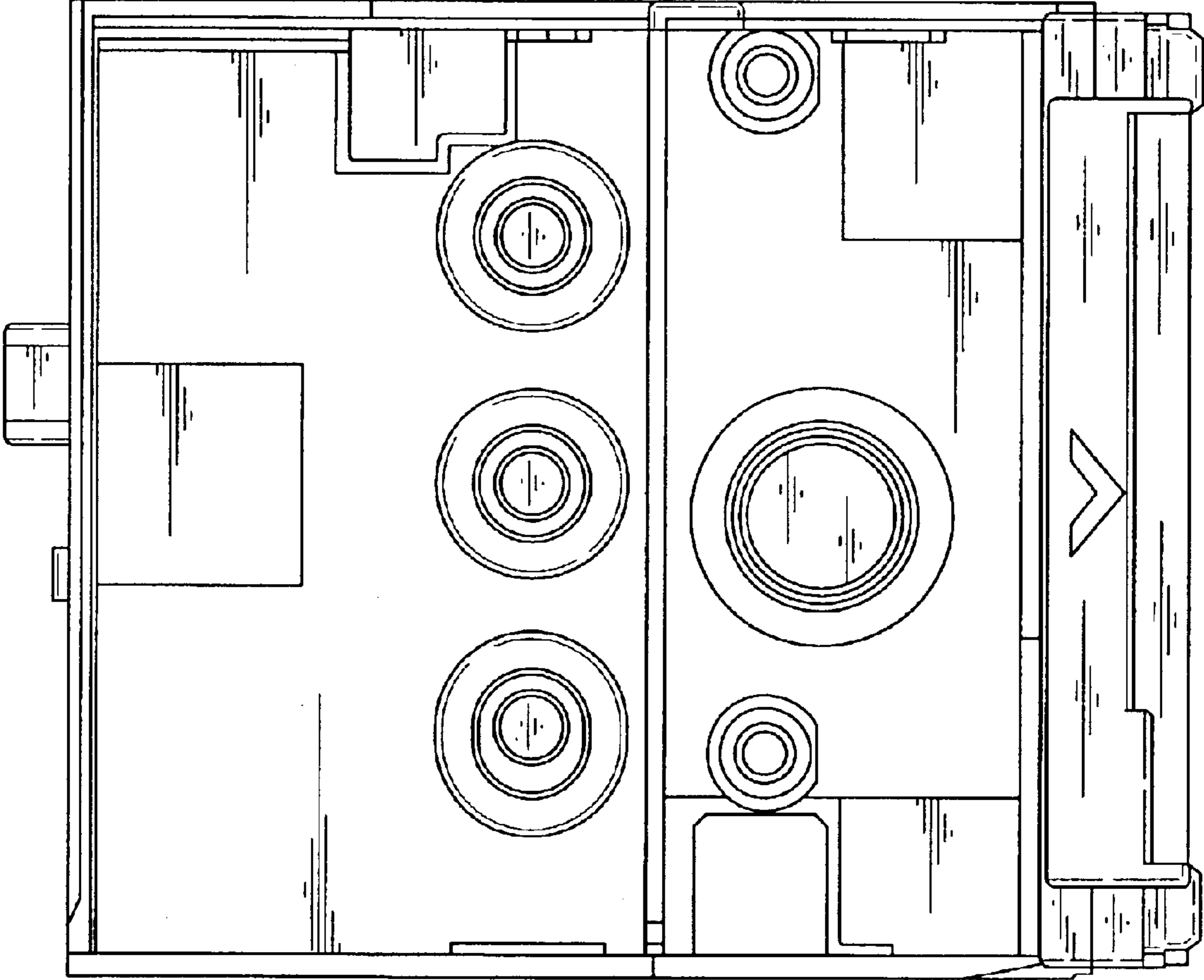

FIG. 4

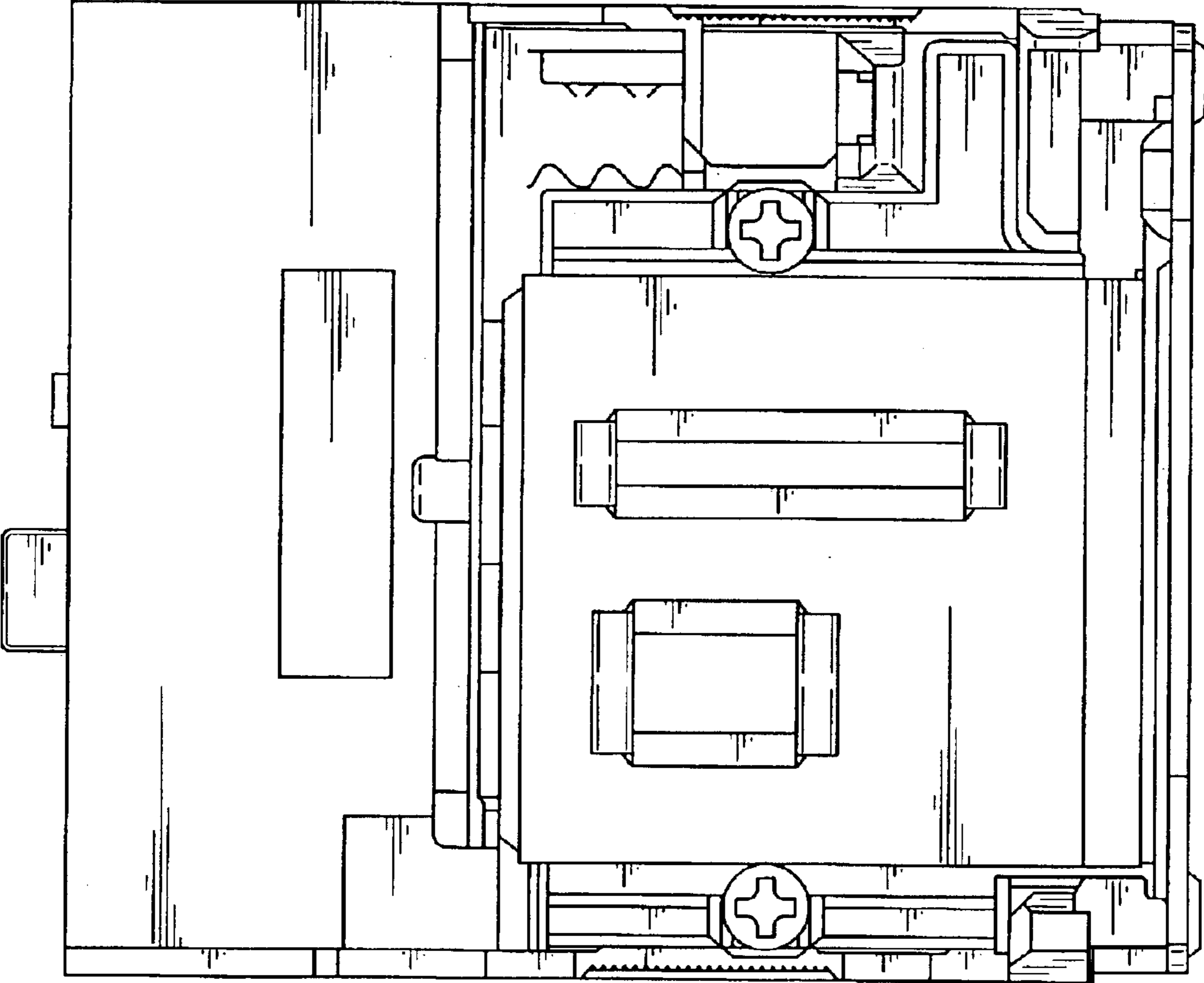

FIG. 5

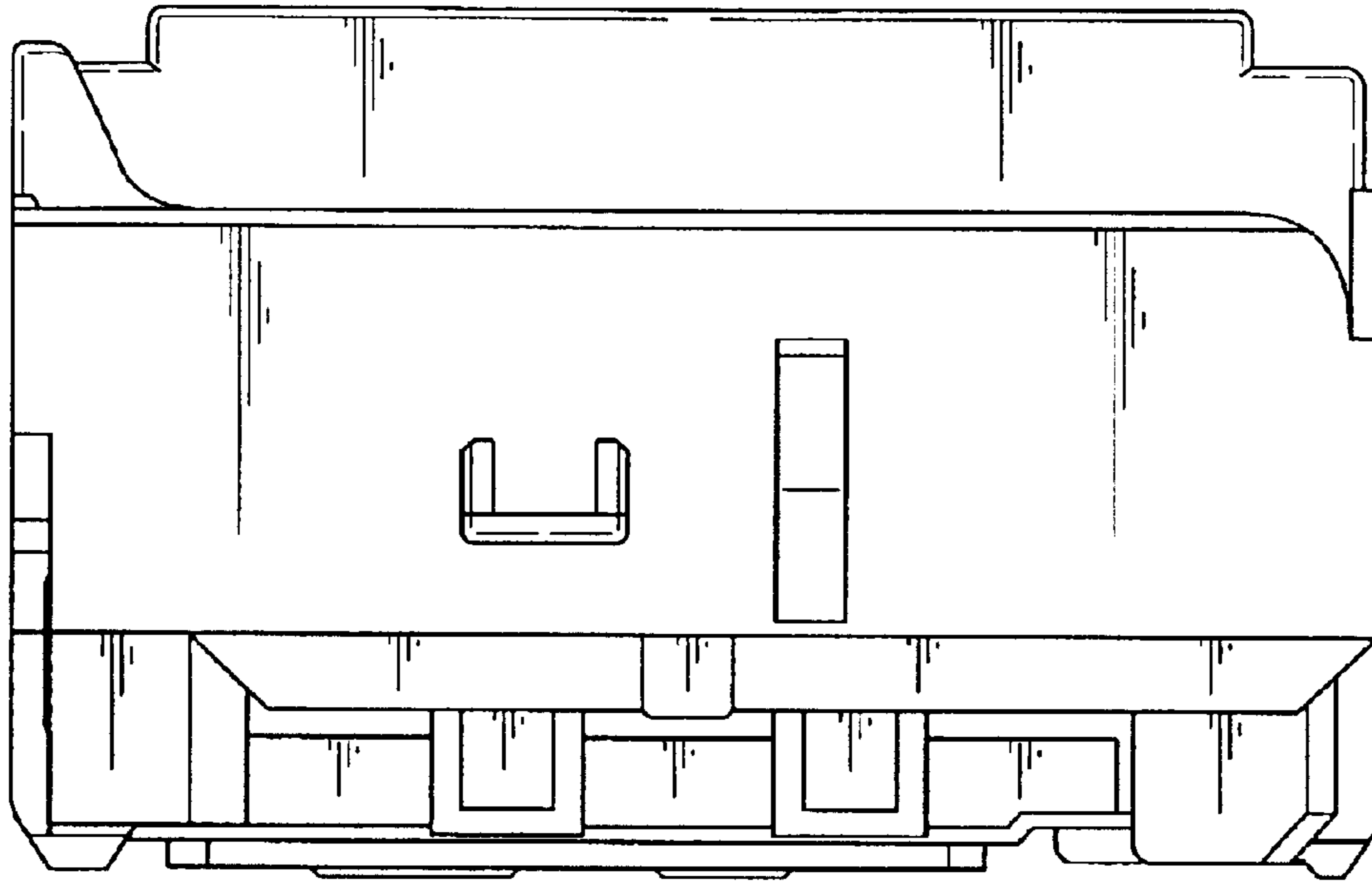

FIG. 6

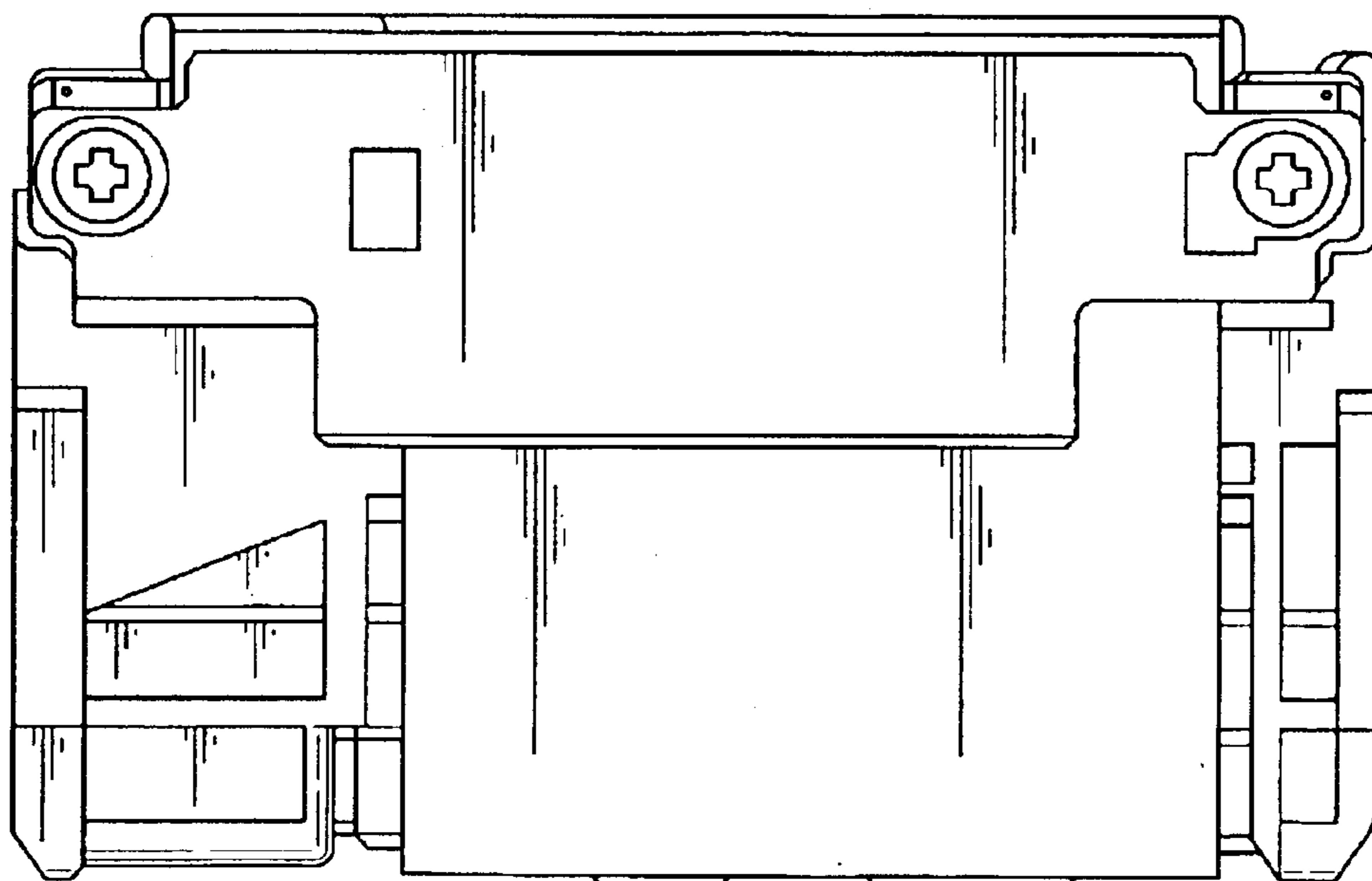

FIG. 7

