

US00D493122S1

(12) **United States Design Patent**  
**Huang et al.**

(10) **Patent No.:** **US D493,122 S**  
(45) **Date of Patent:** **\*\* Jul. 20, 2004**

(54) **SCOOTER**

D443,849 S \* 6/2001 Chen ..... D12/110

(75) Inventors: **Kuo-Feng Huang**, Kaohsiung (TW);  
**Tzu-Pei Chen**, Kaohsiung (TW)

\* cited by examiner

(73) Assignee: **Kwang Yang Motor Co., Ltd.**,  
Kaohsiung (TW)

*Primary Examiner*—Alan P. Douglas

*Assistant Examiner*—Linda Brooks

(74) *Attorney, Agent, or Firm*—Leong C. Lei

(\*\*) Term: **14 Years**

(57) **CLAIM**

The ornamental design for a scooter, as shown and described.

(21) Appl. No.: **29/188,742**

(22) Filed: **Aug. 25, 2003**

**DESCRIPTION**

(51) **LOC (7) Cl.** ..... **12-11**

FIG. 1 is perspective view of a scooter showing my new design;

(52) **U.S. Cl.** ..... **D12/110**

FIG. 2 is a front side elevation view thereof;

(58) **Field of Search** ..... D12/110; 180/219,

FIG. 3 is a rear side elevation view thereof;

180/225, 229

FIG. 4 is a left side elevation view thereof;

FIG. 5 is a right side elevation view thereof;

FIG. 6 is a top plan view thereof; and,

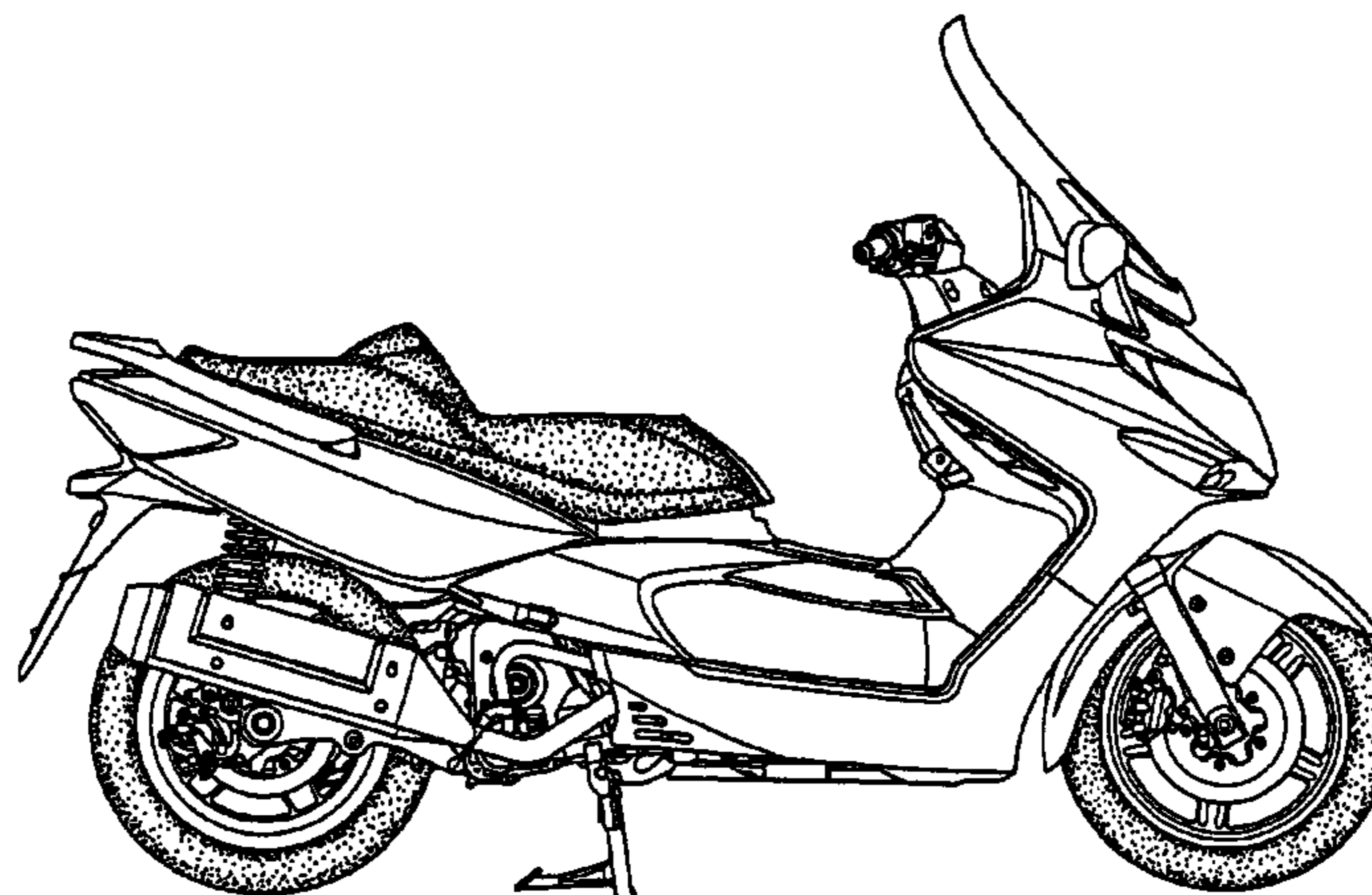
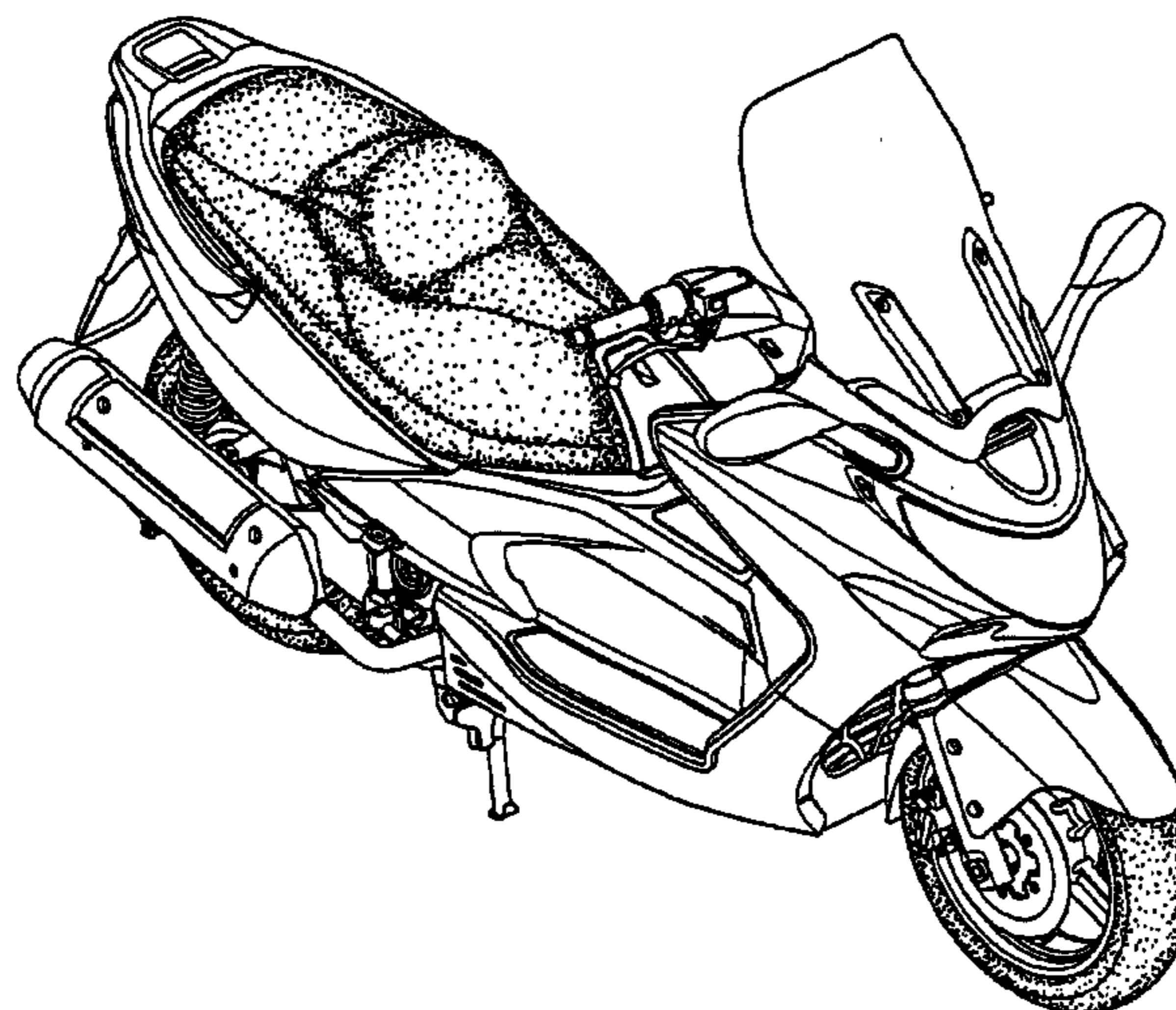
FIG. 7 is a bottom plan view thereof.

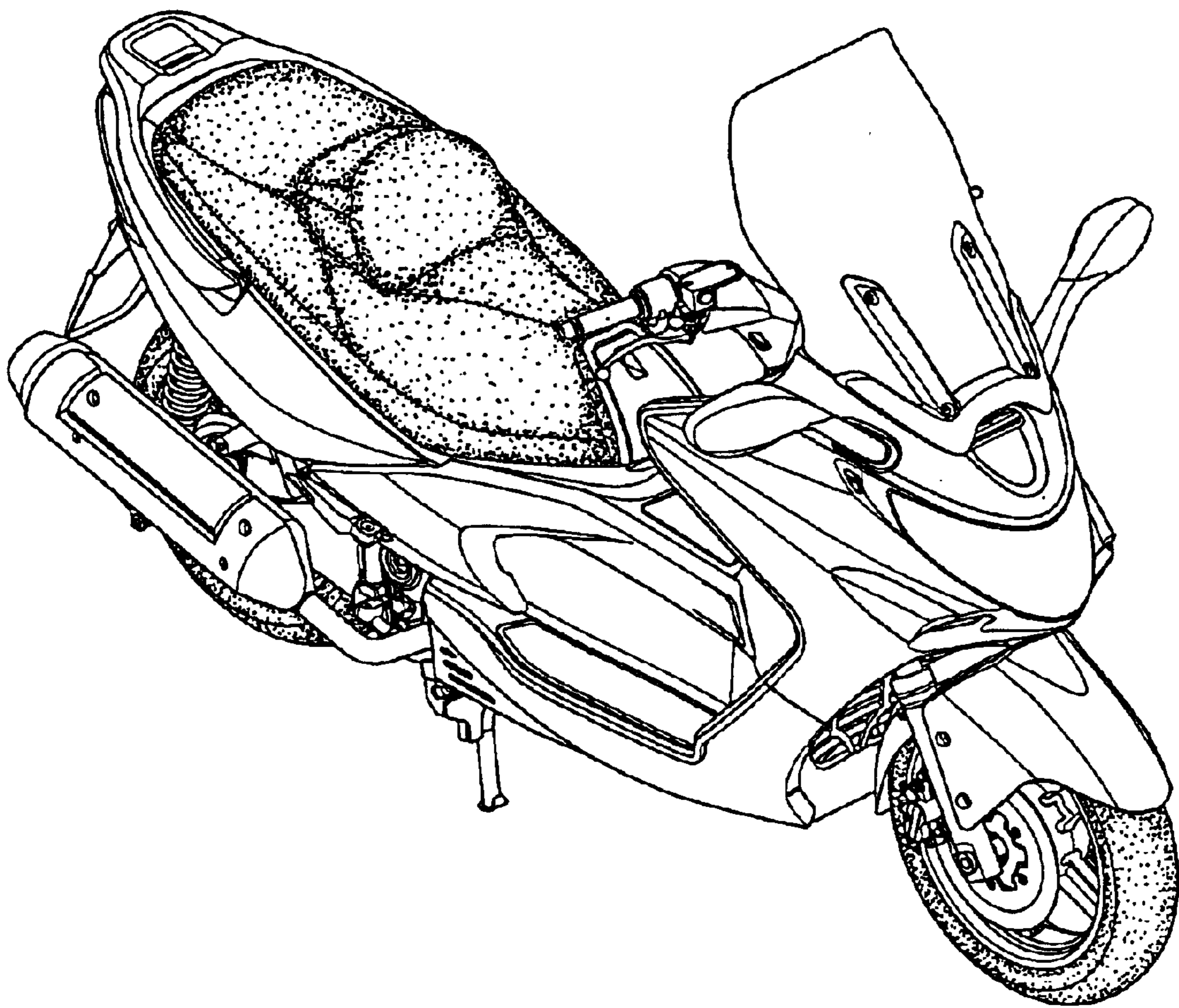
(56) **References Cited**

**U.S. PATENT DOCUMENTS**

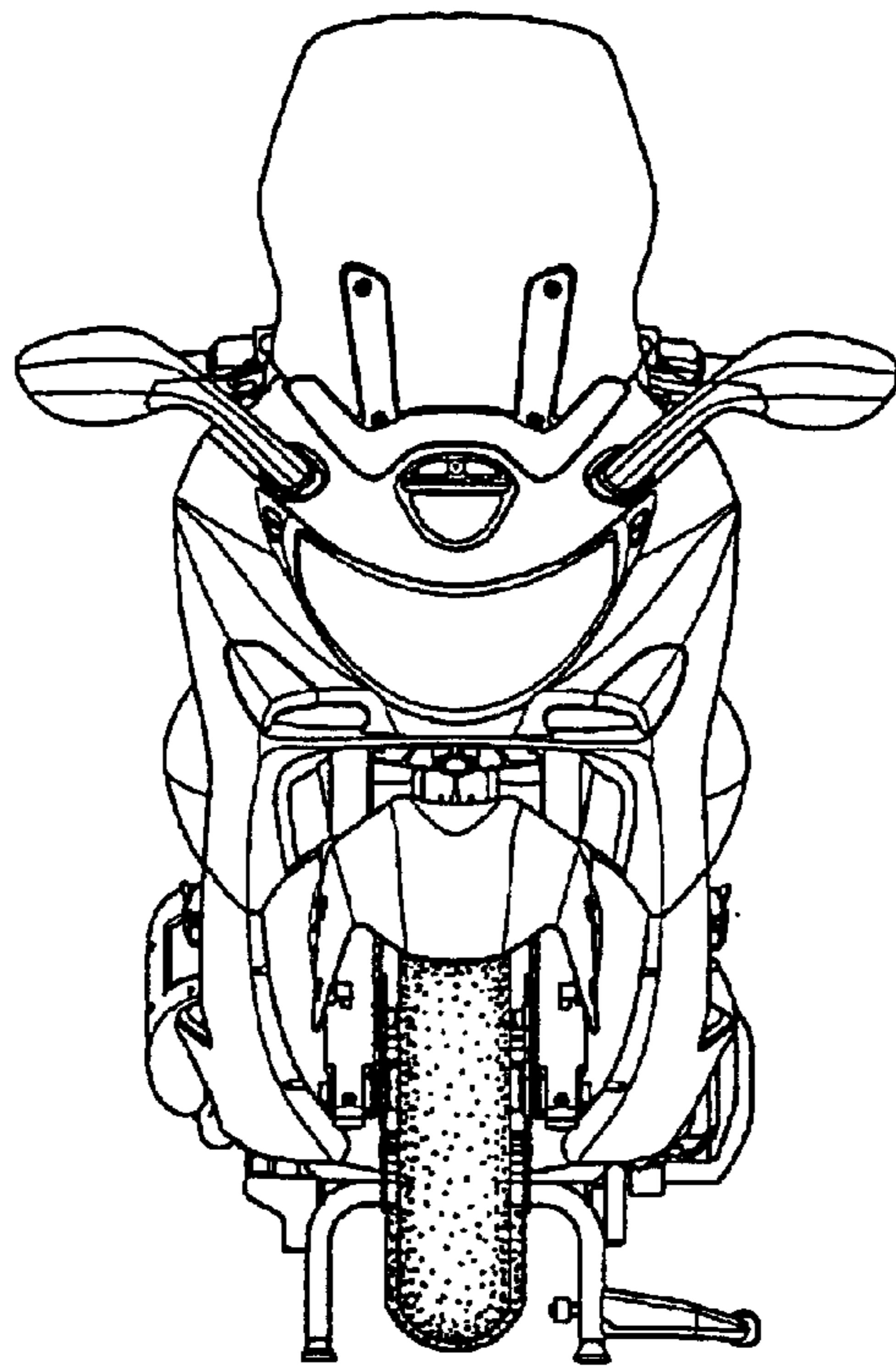
D399,174 S \* 10/1998 Takeshita et al. .... D12/110

**1 Claim, 4 Drawing Sheets**

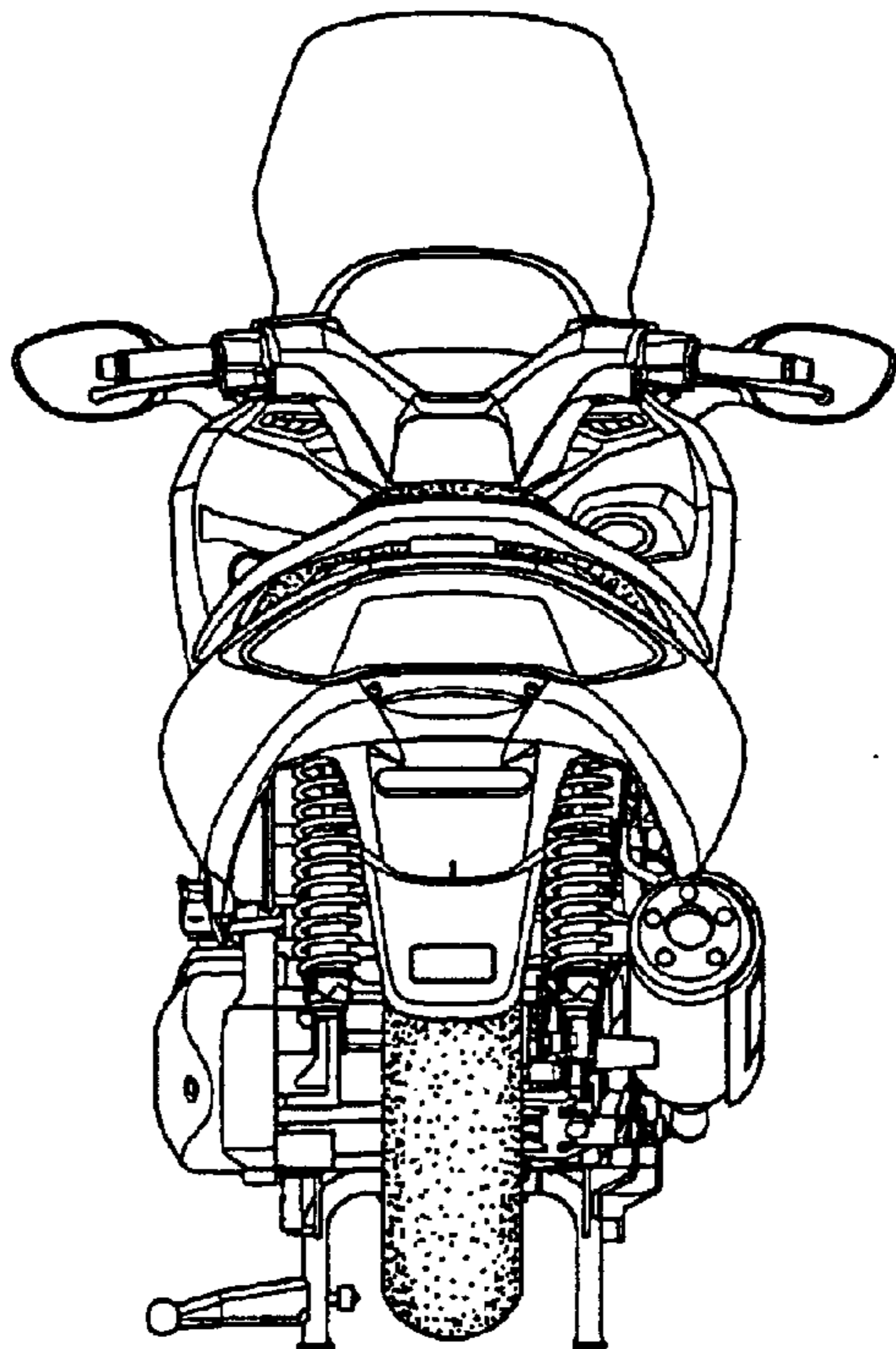




**FIG. 1**



**FIG. 2**



**FIG. 3**

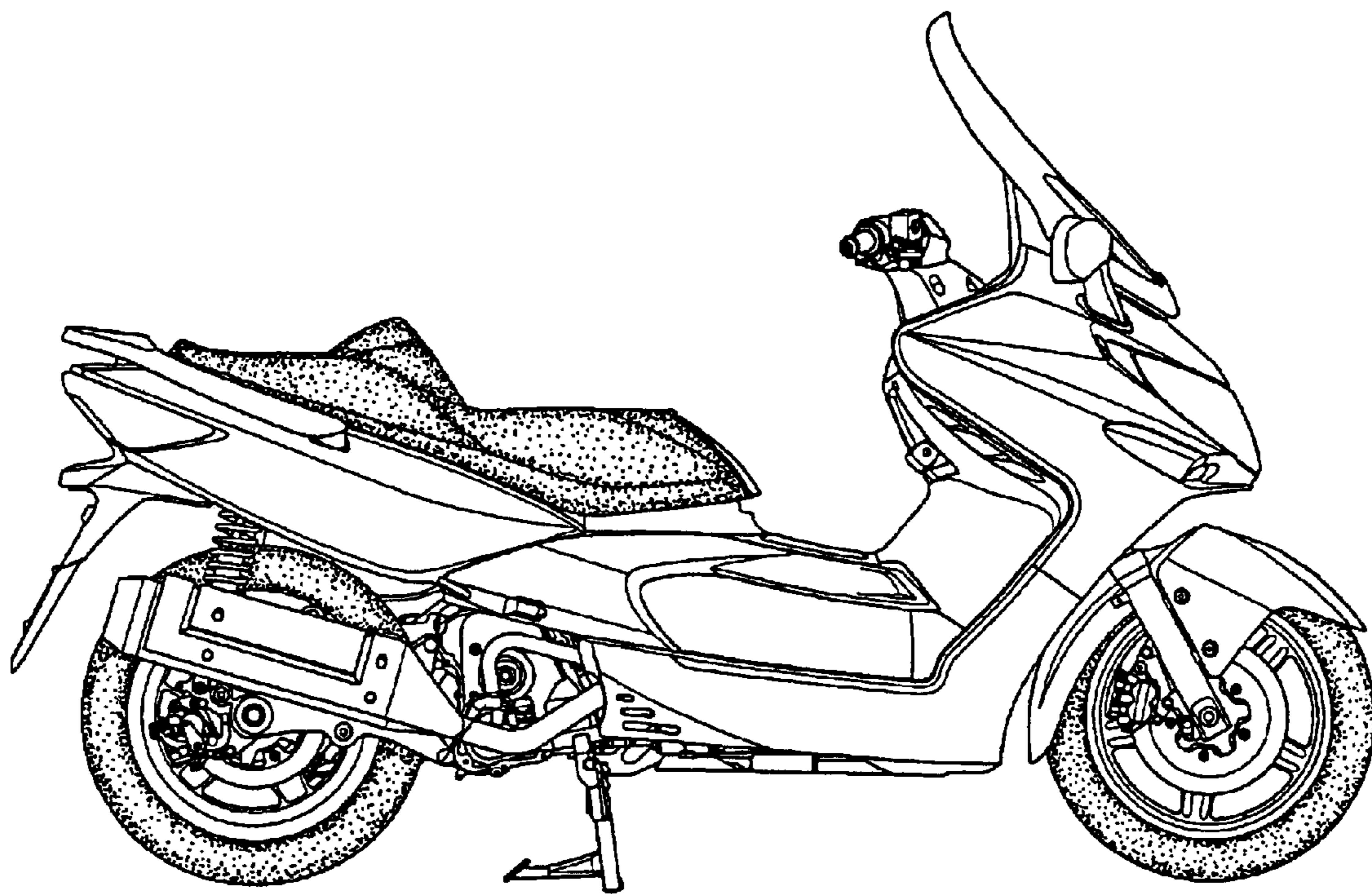


FIG. 4

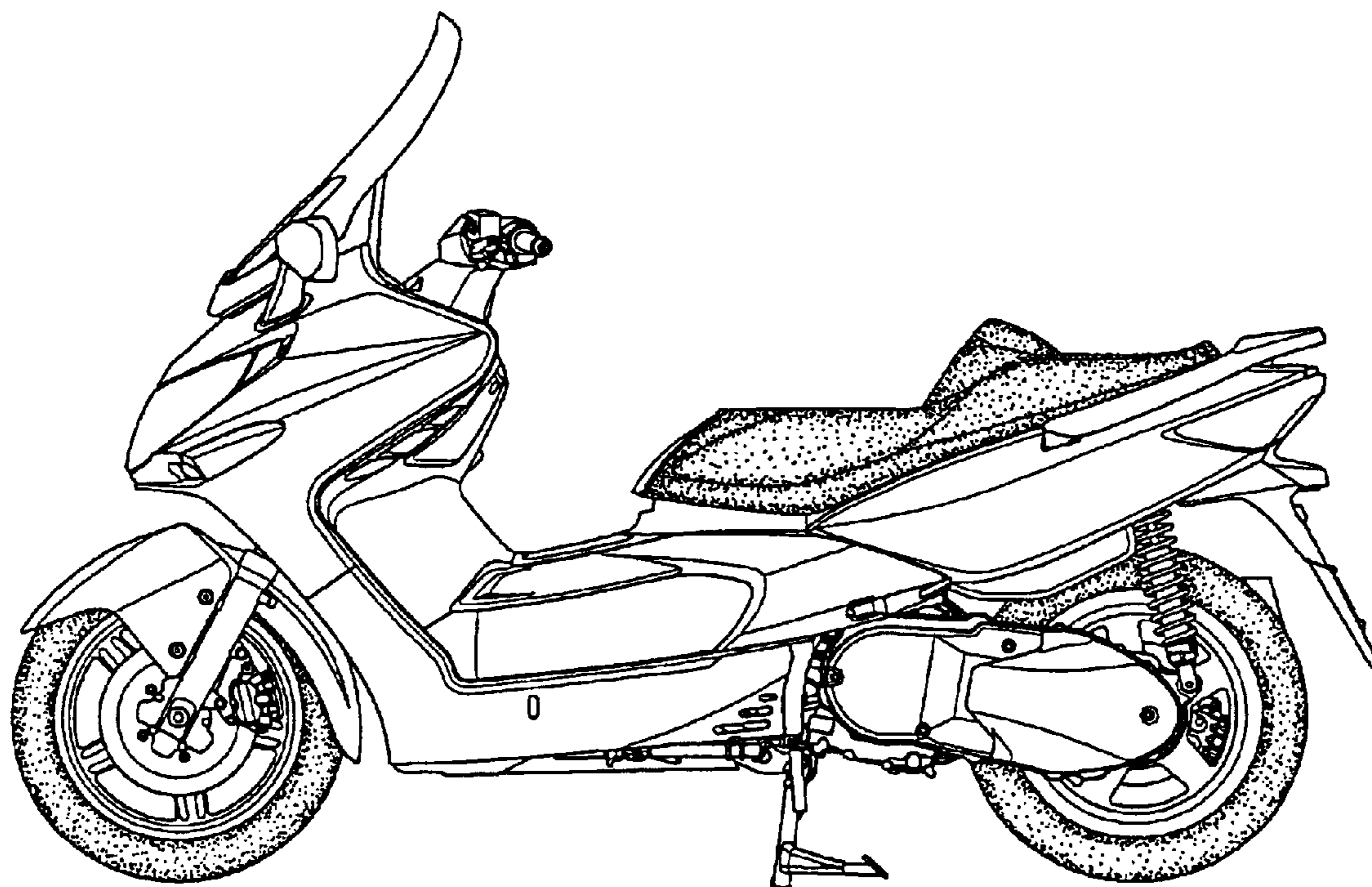


FIG. 5

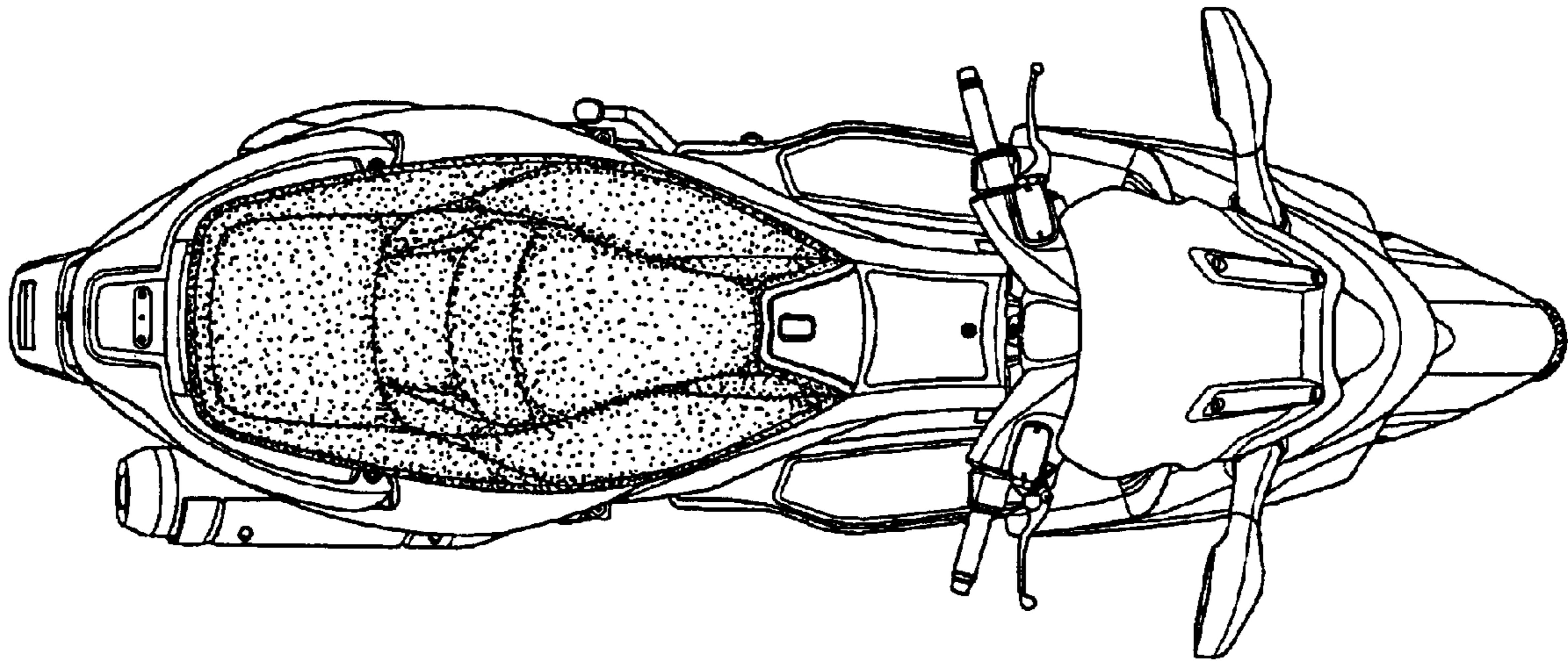


FIG. 6

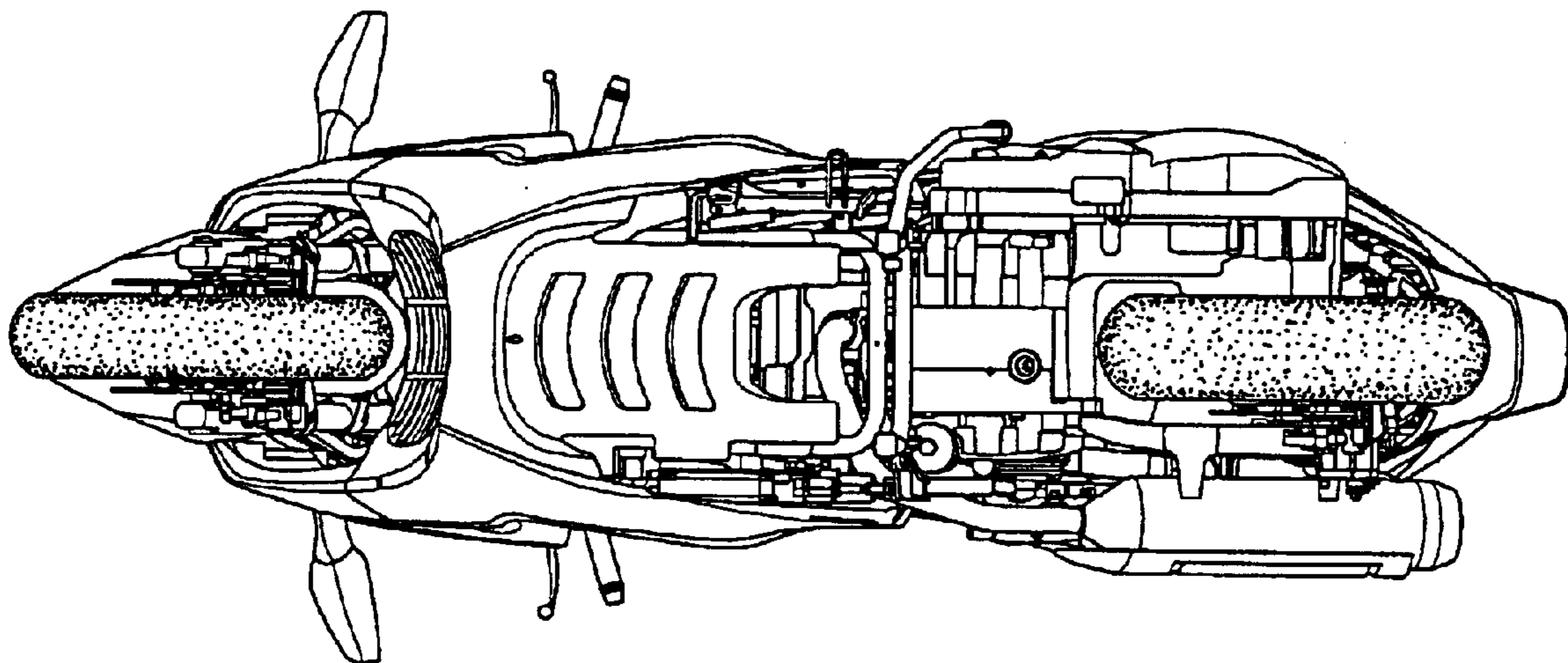


FIG. 7