

US00D493009S1

(12) **United States Design Patent**
Ken

(10) **Patent No.:** **US D493,009 S**

(45) **Date of Patent:** **** Jul. 13, 2004**

(54) **SHELF LIGHT**

(75) **Inventor:** **Chi Hang Ken, Kwai Chung (HK)**

(73) **Assignee:** **Luen Yick Electrical Mfg. Co., Ltd.,
New Territories (HK)**

(**) **Term:** **14 Years**

(21) **Appl. No.:** **29/186,012**

(22) **Filed:** **Jul. 9, 2003**

(51) **LOC (7) Cl.** **26-05**

(52) **U.S. Cl.** **D26/51; D26/72; D6/511**

(58) **Field of Search** **D26/51, 72, 75,
D26/76; D6/511; 362/127, 132, 151**

(56) **References Cited**

U.S. PATENT DOCUMENTS

D79,072 S	*	7/1929	Green	D26/51
D107,062 S	*	11/1937	Arenberg	D6/566
D146,982 S	*	6/1947	Phillips	D12/44
D146,983 S	*	6/1947	Phillips	D12/44
D311,967 S	*	11/1990	Herst et al.	D26/85

D330,090 S	*	10/1992	Walter et al.	D26/51
5,984,486 A	*	11/1999	Munz et al.	362/33
D423,840 S	*	5/2000	Carville et al.	D6/511
6,565,234 B1	*	5/2003	Skegin et al.	362/294

* cited by examiner

Primary Examiner—Clare E Heflin

(74) *Attorney, Agent, or Firm*—Rabin & Berdo, P.C.

(57) **CLAIM**

The ornamental design for a shelf light, as shown and described.

DESCRIPTION

FIG. 1 is a perspective view of a shelf light showing my new design;

FIG. 2 is a front view thereof;

FIG. 3 is a rear view thereof;

FIG. 4 is a left side view thereof;

FIG. 5 is a right side view thereof;

FIG. 6 is a top plan view thereof; and,

FIG. 7 is a bottom plan view thereof.

1 Claim, 4 Drawing Sheets

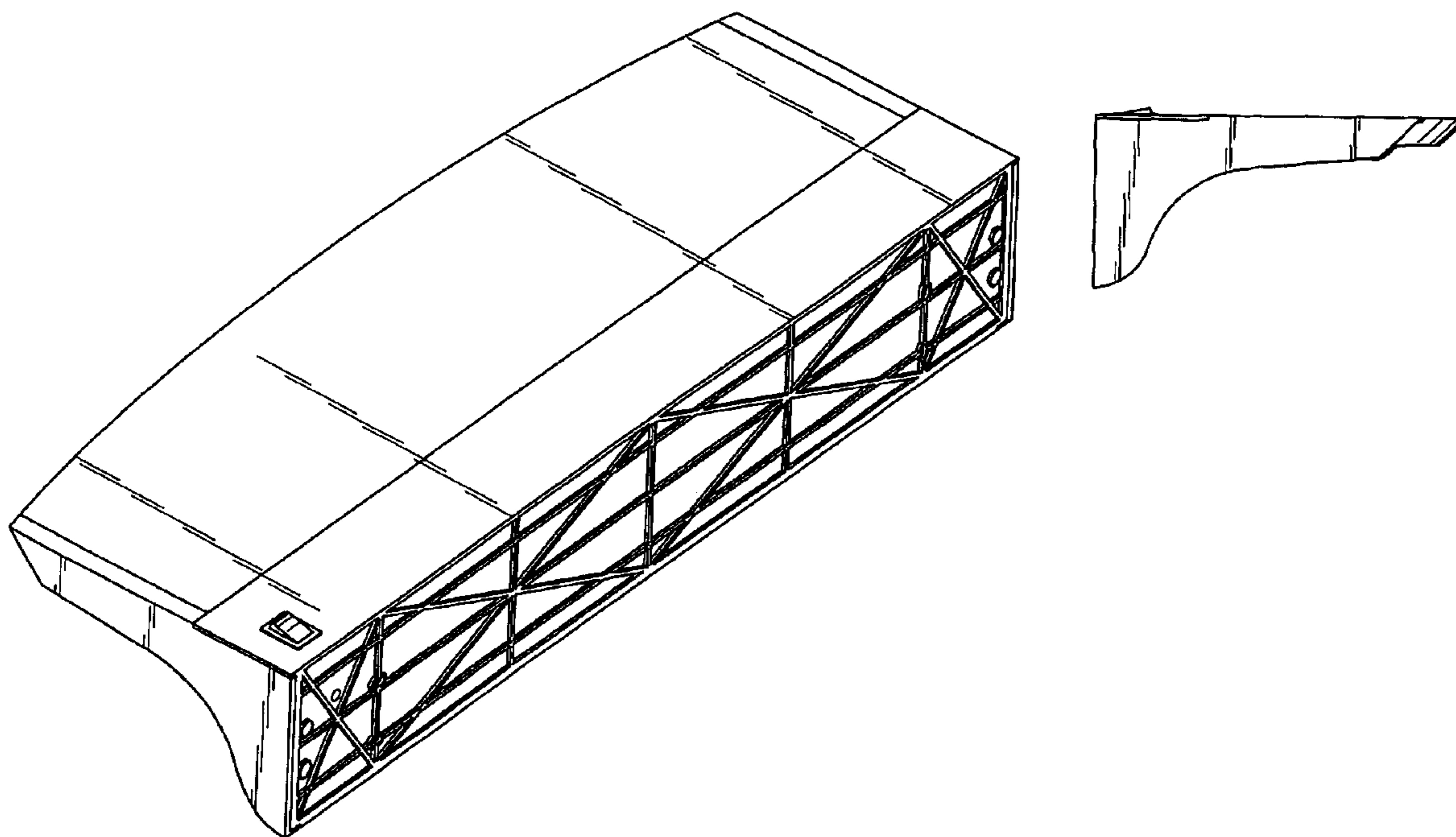

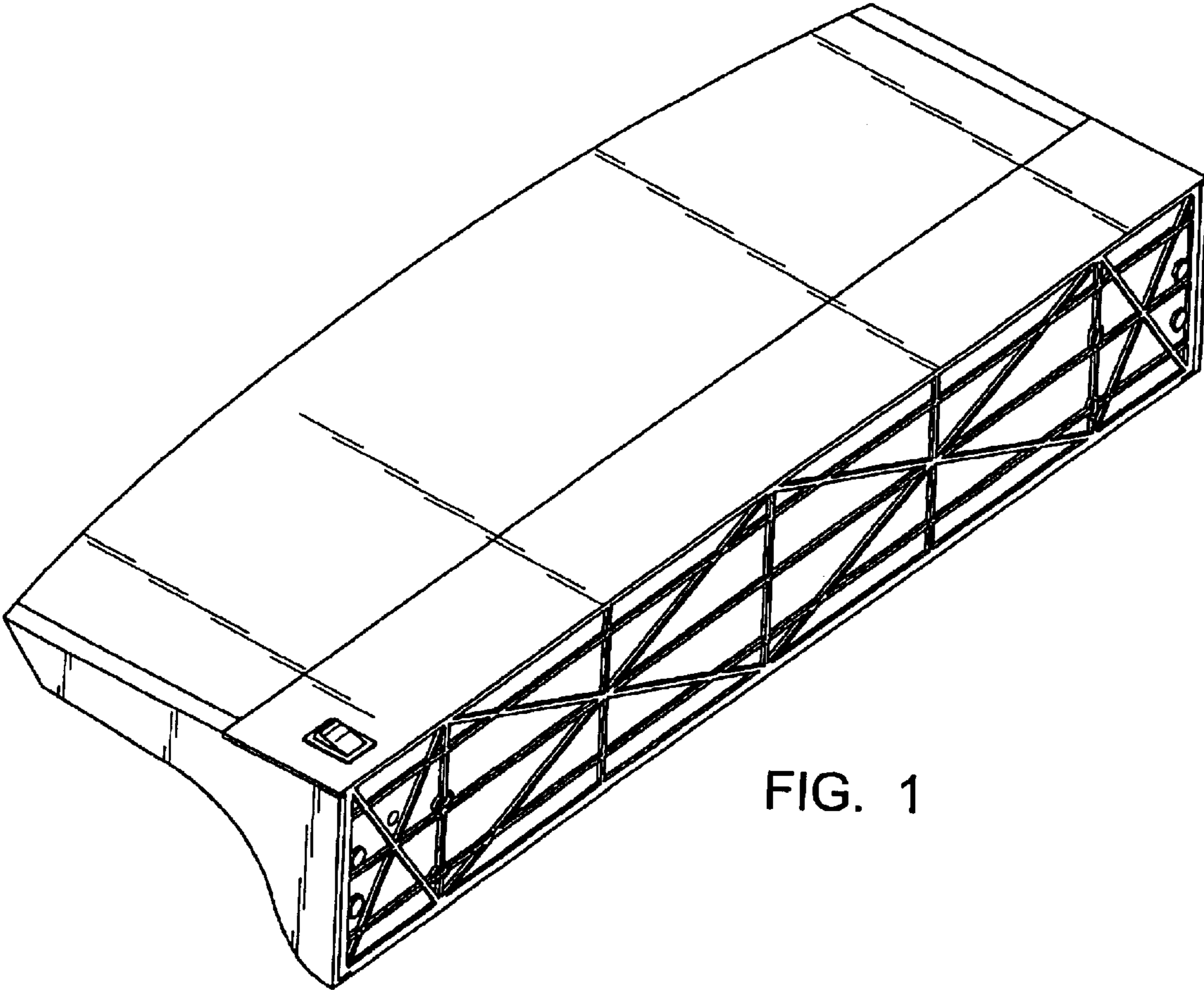

FIG. 1

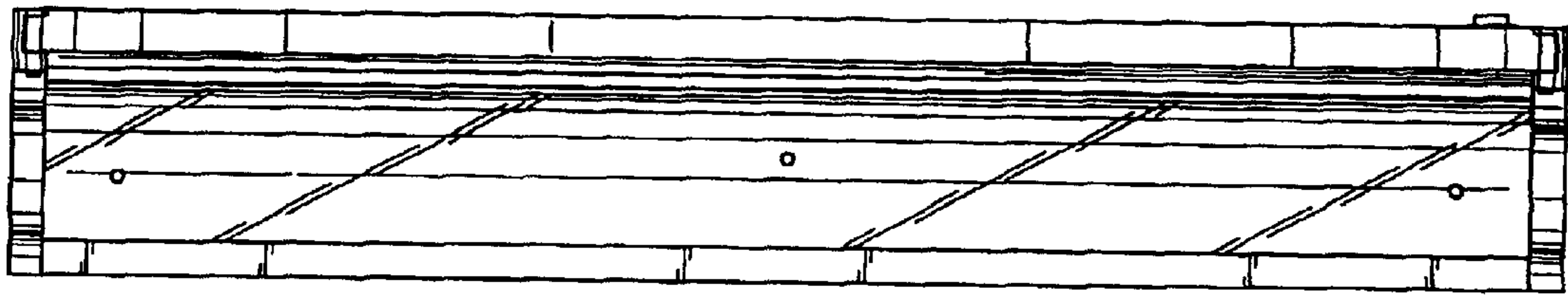

FIG. 2

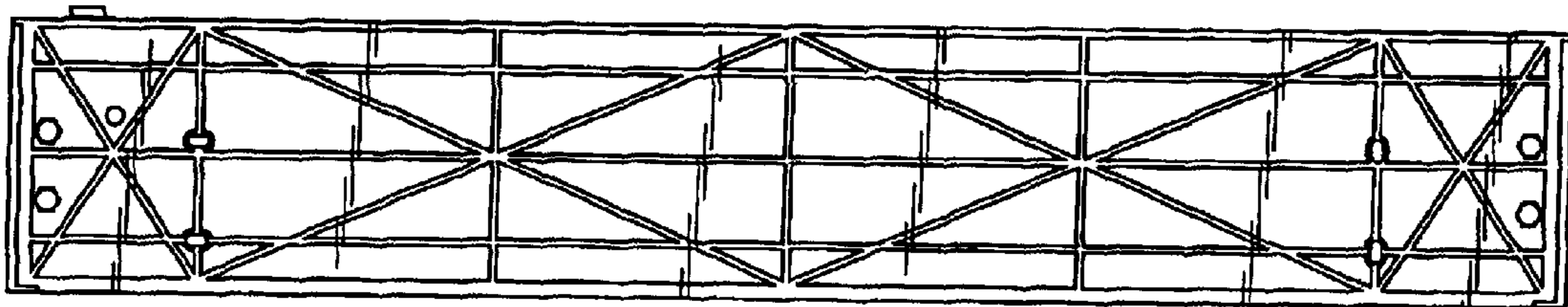

FIG. 3

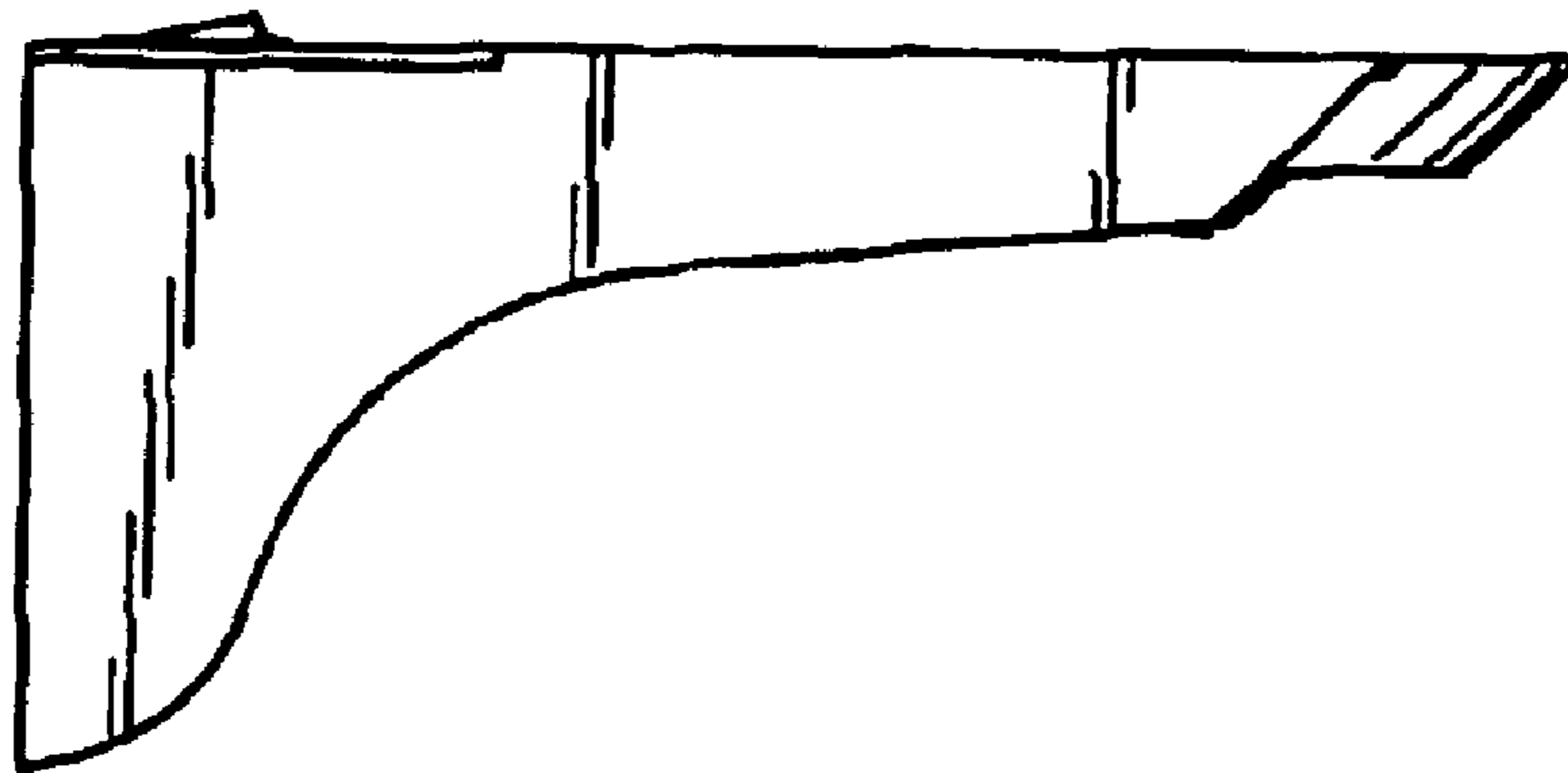

FIG. 4

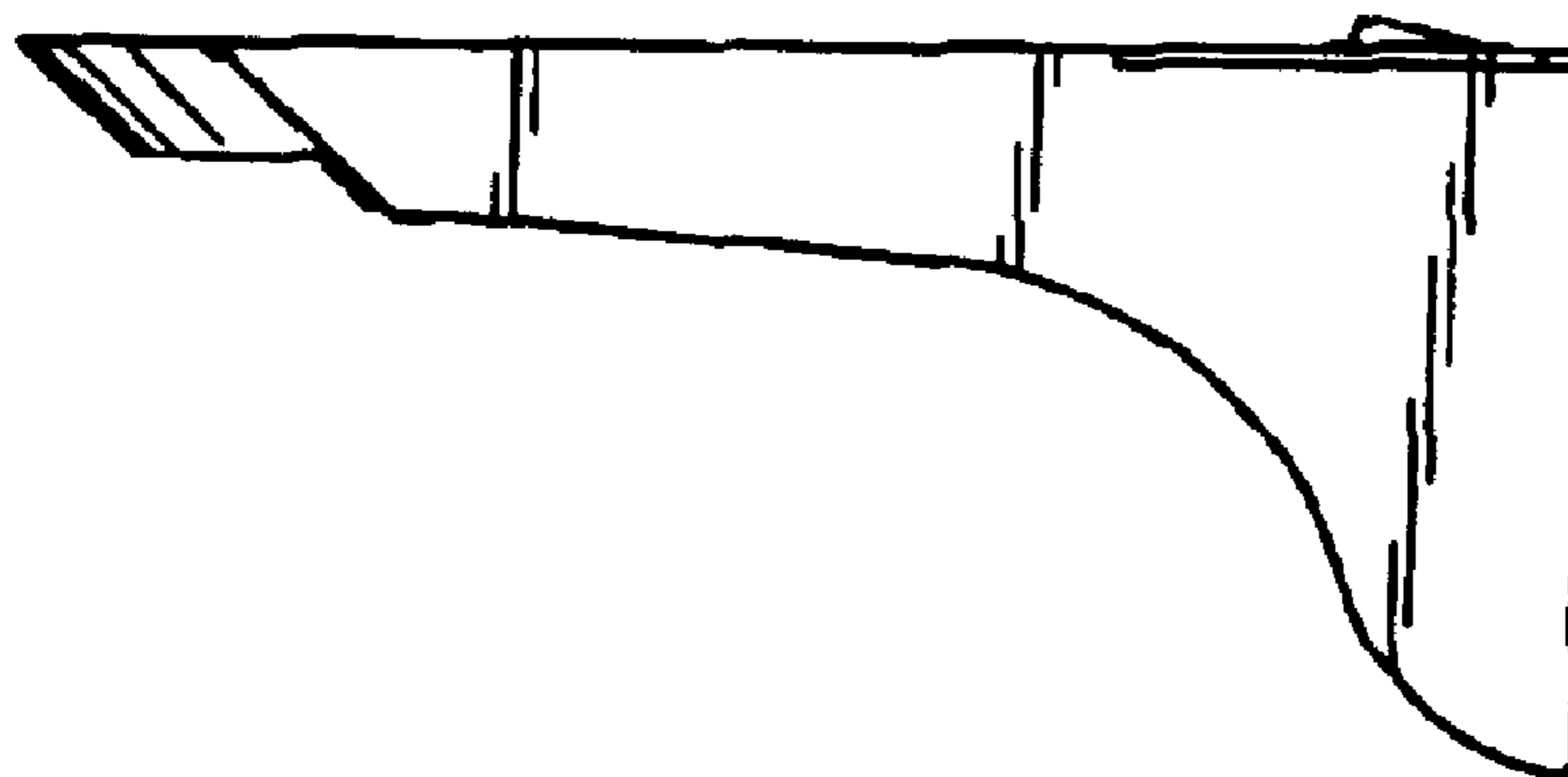

FIG. 5

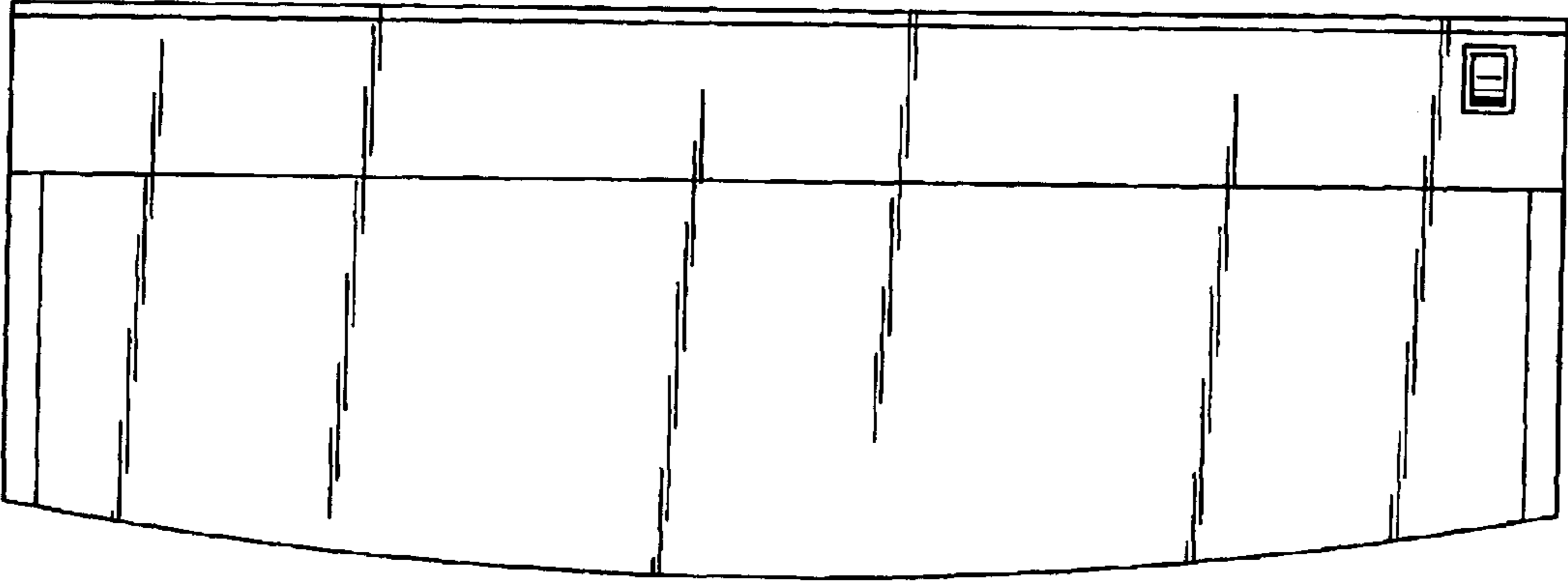

FIG. 6

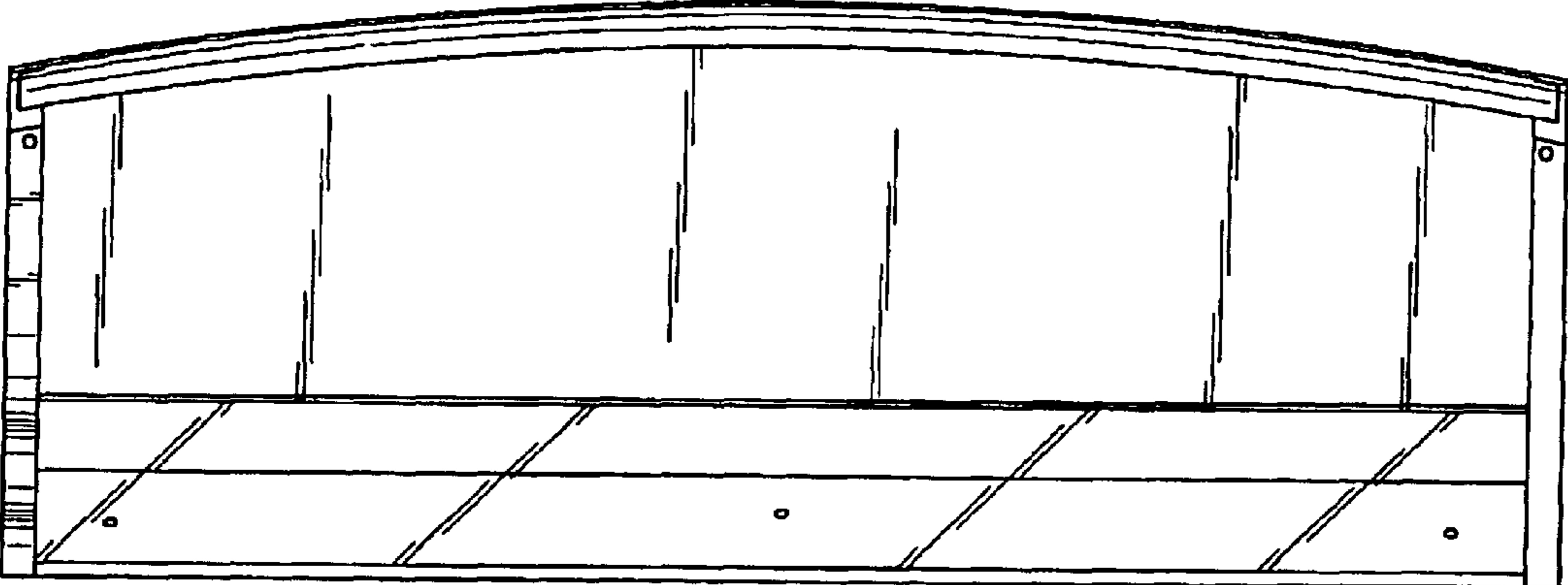

FIG. 7

UNITED STATES PATENT AND TRADEMARK OFFICE
CERTIFICATE OF CORRECTION

PATENT NO. : Des. 493,009 S
DATED : July 13, 2004
INVENTOR(S) : Chi Hang Kan

Page 1 of 1

It is certified that error appears in the above-identified patent and that said Letters Patent is hereby corrected as shown below:

Title page.

Item [12], Title, change "**Ken**" to -- **KAN** --, therefor.

Item [75], Inventors, change "**Chi Hang KEN**" to -- **Chi Hang KAN** --, therefor.

Signed and Sealed this

Twenty-third Day of November, 2004

A handwritten signature in black ink, reading "Jon W. Dudas". The signature is written in a cursive style with a large, looped initial "J".

JON W. DUDAS

Director of the United States Patent and Trademark Office