

US00D492961S1

(12) **United States Design Patent**
Miyahara et al.

(10) **Patent No.:** **US D492,961 S**
(45) **Date of Patent:** **** Jul. 13, 2004**

(54) **COMPUTER PRINTER**

(75) Inventors: **Kazuhiko Miyahara**, Yokohama (JP);
Toshimi Chiba, Chigasaki (JP);
Hiroyuki Fukushima, Tokyo (JP)

(73) Assignee: **Canon Kabushiki Kaisha**, Tokyo (JP)

(**) Term: **14 Years**

(21) Appl. No.: **29/174,353**

(22) Filed: **Jan. 17, 2003**

(30) **Foreign Application Priority Data**

Jul. 30, 2002 (JP) 2002-020397

(51) **LOC (7) Cl.** **14-02**

(52) **U.S. Cl.** **D18/54**

(58) **Field of Search** D18/50, 53, 54,
D18/55, 36-39; D14/421-422, 425, 462-470,
371, 374-378, 380-381; 400/613, 613.1-613.4,
691-694, 690.1-690.4

(56) **References Cited**

U.S. PATENT DOCUMENTS

- D231,539 S * 4/1974 MacConkey D18/50
- D295,416 S * 4/1988 Glaberson D14/116
- D318,291 S * 7/1991 Ohnumata D18/36
- D329,862 S * 9/1992 Watanabe et al. D18/36
- D379,827 S * 6/1997 Andre D18/54

- D390,257 S * 2/1998 Dwyer et al. D18/55
- D433,443 S 11/2000 Ito et al. D18/55
- D435,266 S 12/2000 Sekine et al. D18/55
- D439,607 S 3/2001 Inoue et al. D18/54
- D445,823 S * 7/2001 Kawahara et al. D18/50
- D448,043 S * 9/2001 Kawahara et al. D18/50
- D467,963 S 12/2002 Miyahara et al. D18/54
- D468,764 S 1/2003 Miyahara et al. D18/54
- D474,499 S * 5/2003 Isono D18/50

* cited by examiner

Primary Examiner—Cathy Anne MacCormac

(74) *Attorney, Agent, or Firm*—Fitzpatrick, Cella, Harper & Scinto

(57) **CLAIM**

The ornamental design for a computer printer, as shown and described.

DESCRIPTION

FIG. 1 is a front view of a computer printer showing our new design;

FIG. 2 is a rear view thereof;

FIG. 3 is a top plan view thereof;

FIG. 4 is a bottom plan view thereof;

FIG. 5 is a left side view thereof;

FIG. 6 is a right side view thereof; and,

FIG. 7 is a perspective view thereof.

1 Claim, 4 Drawing Sheets

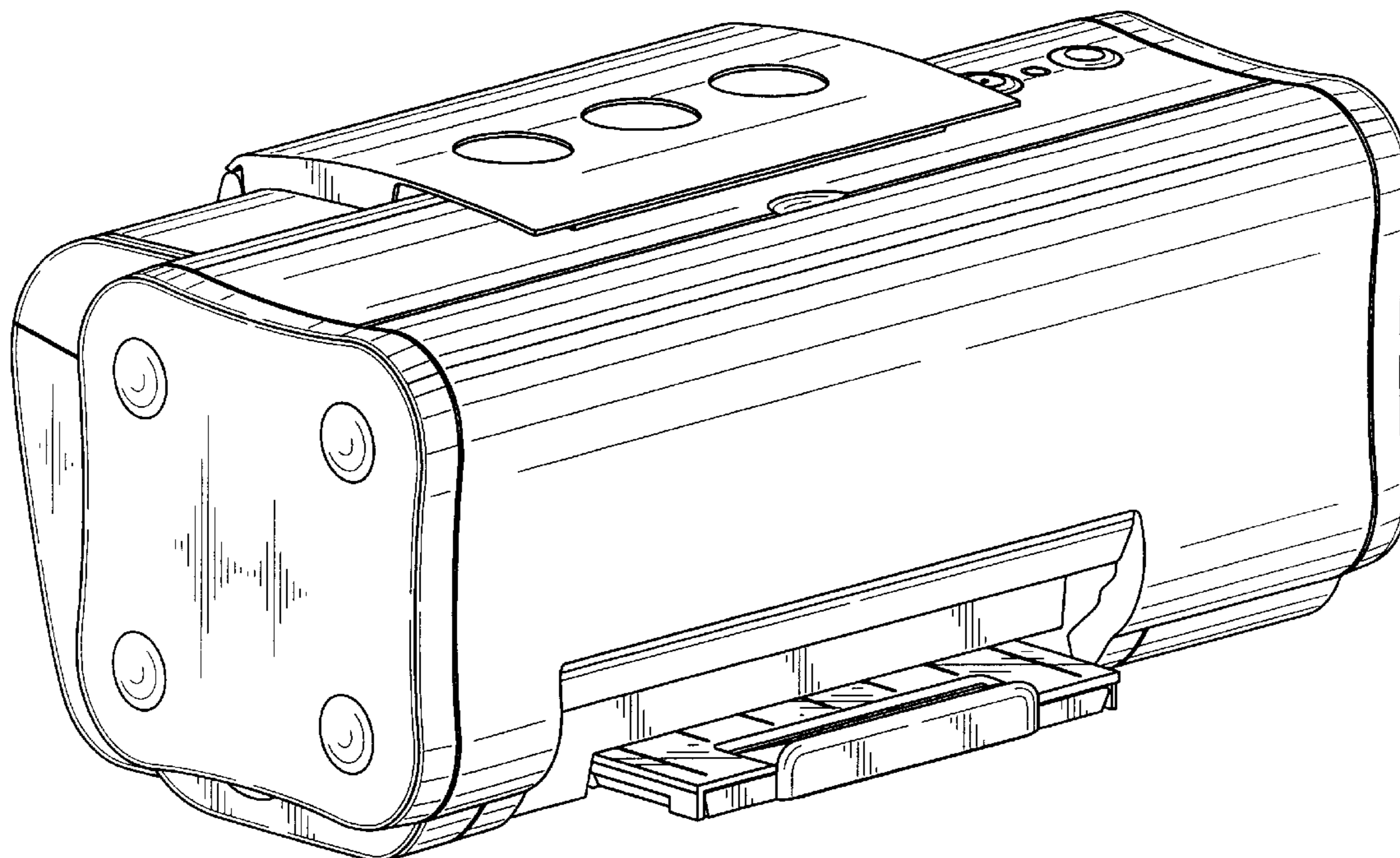

FIG. 1

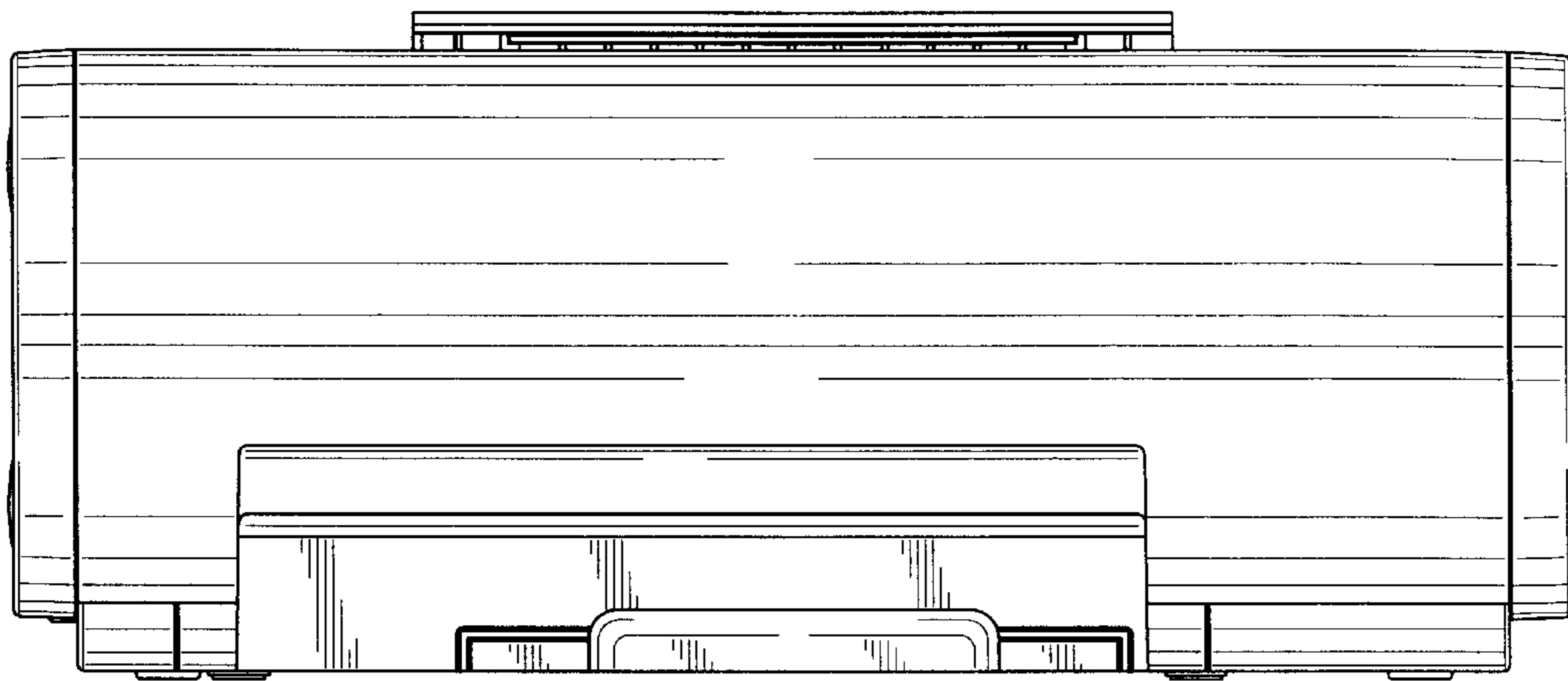

FIG. 2

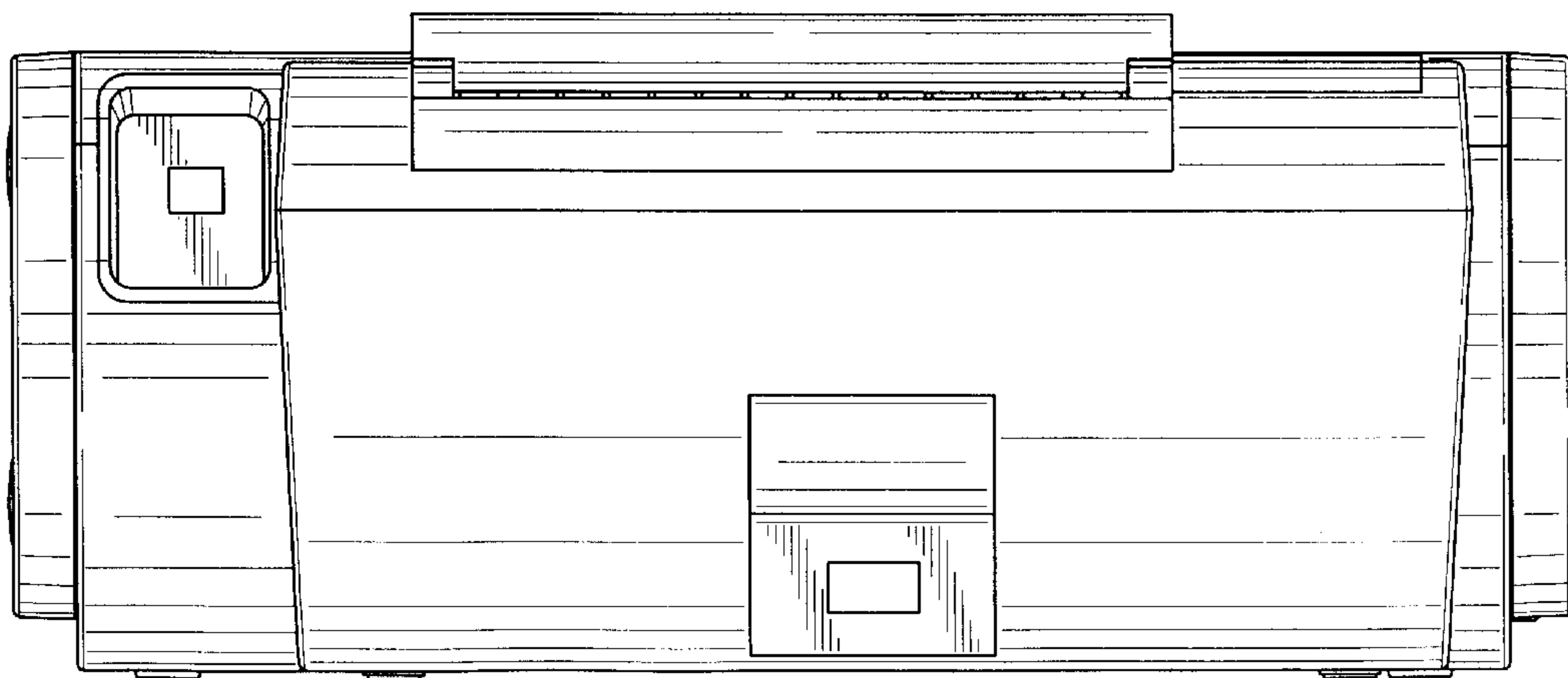

FIG. 3

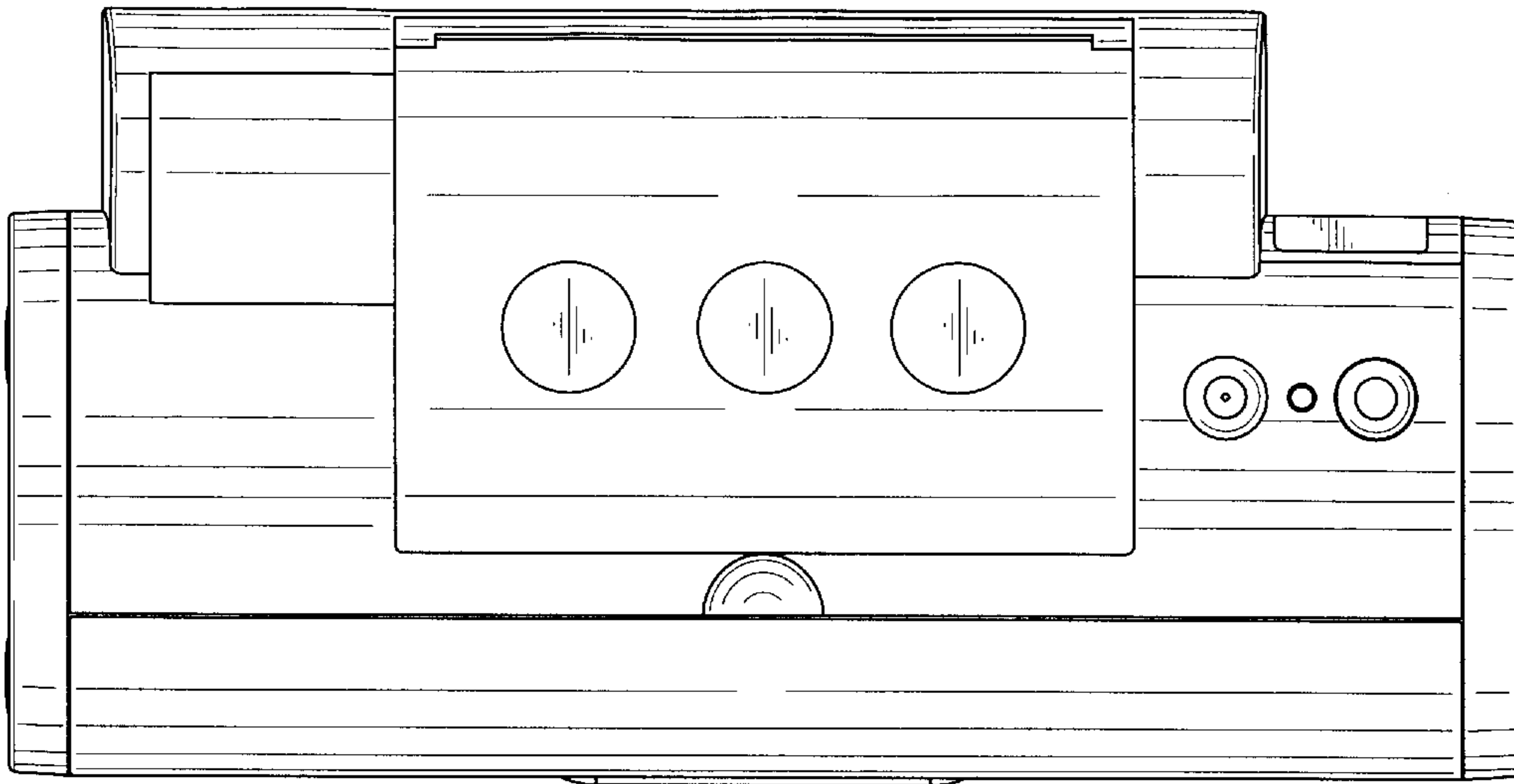

FIG. 4

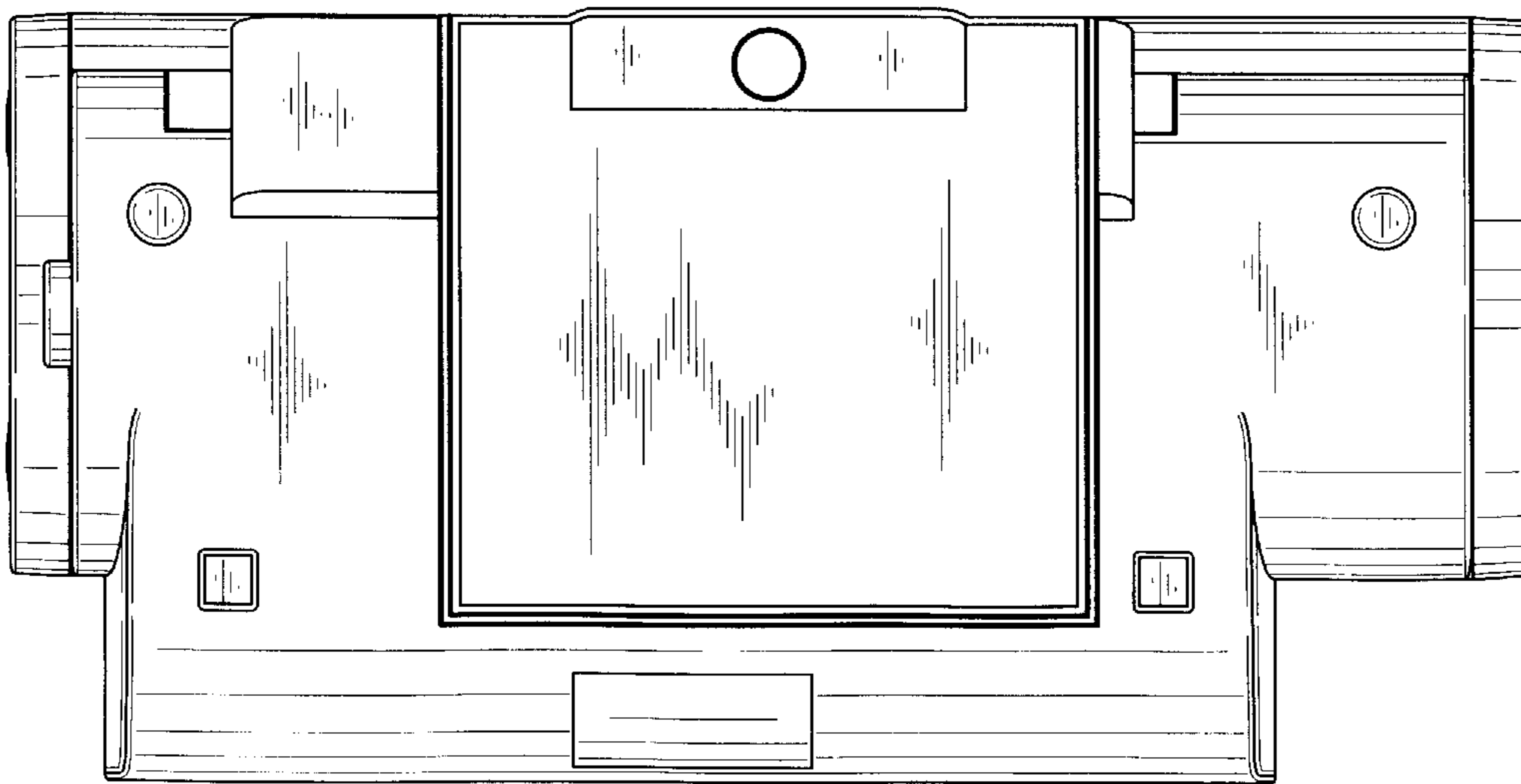

FIG. 5

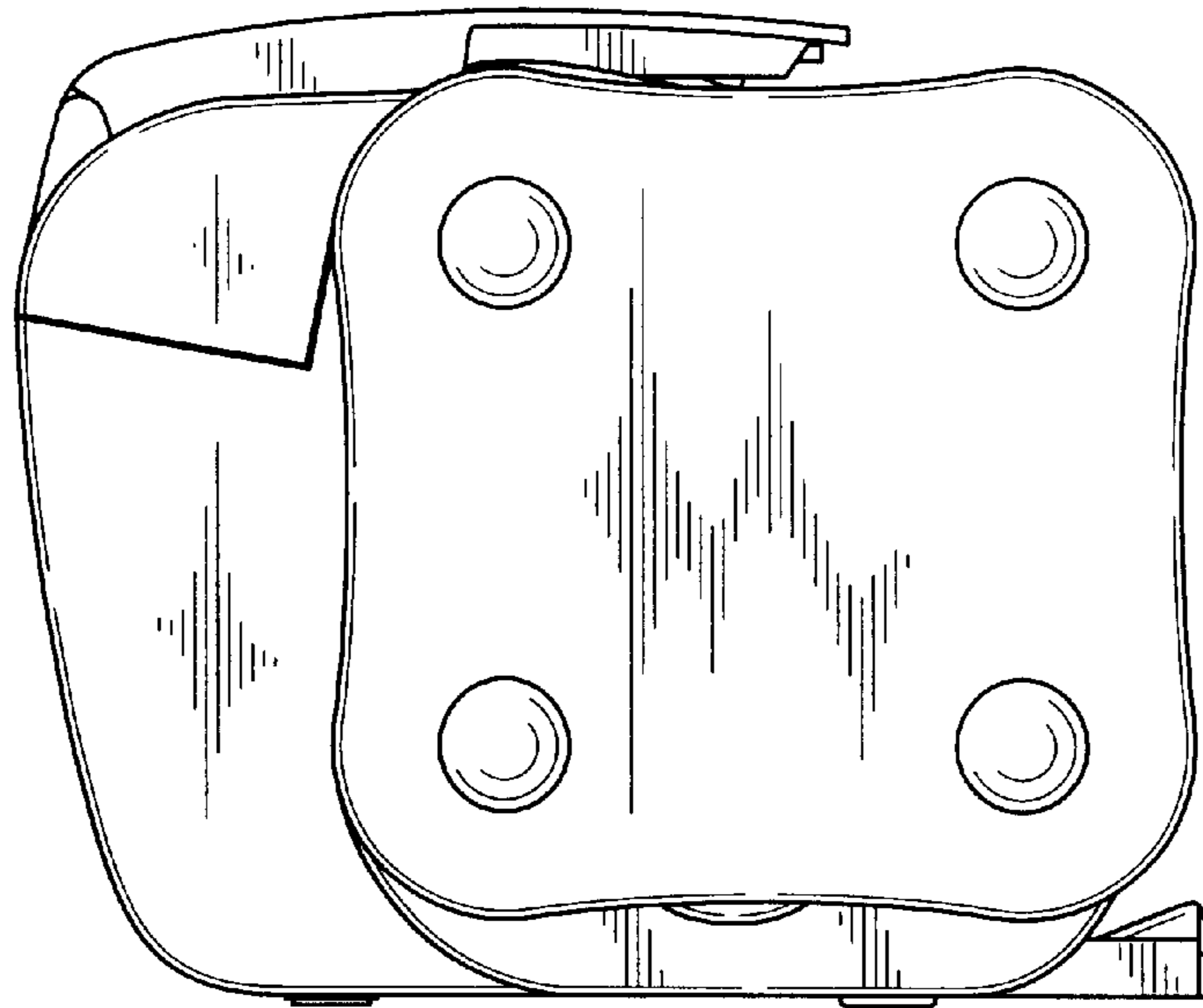

FIG. 6

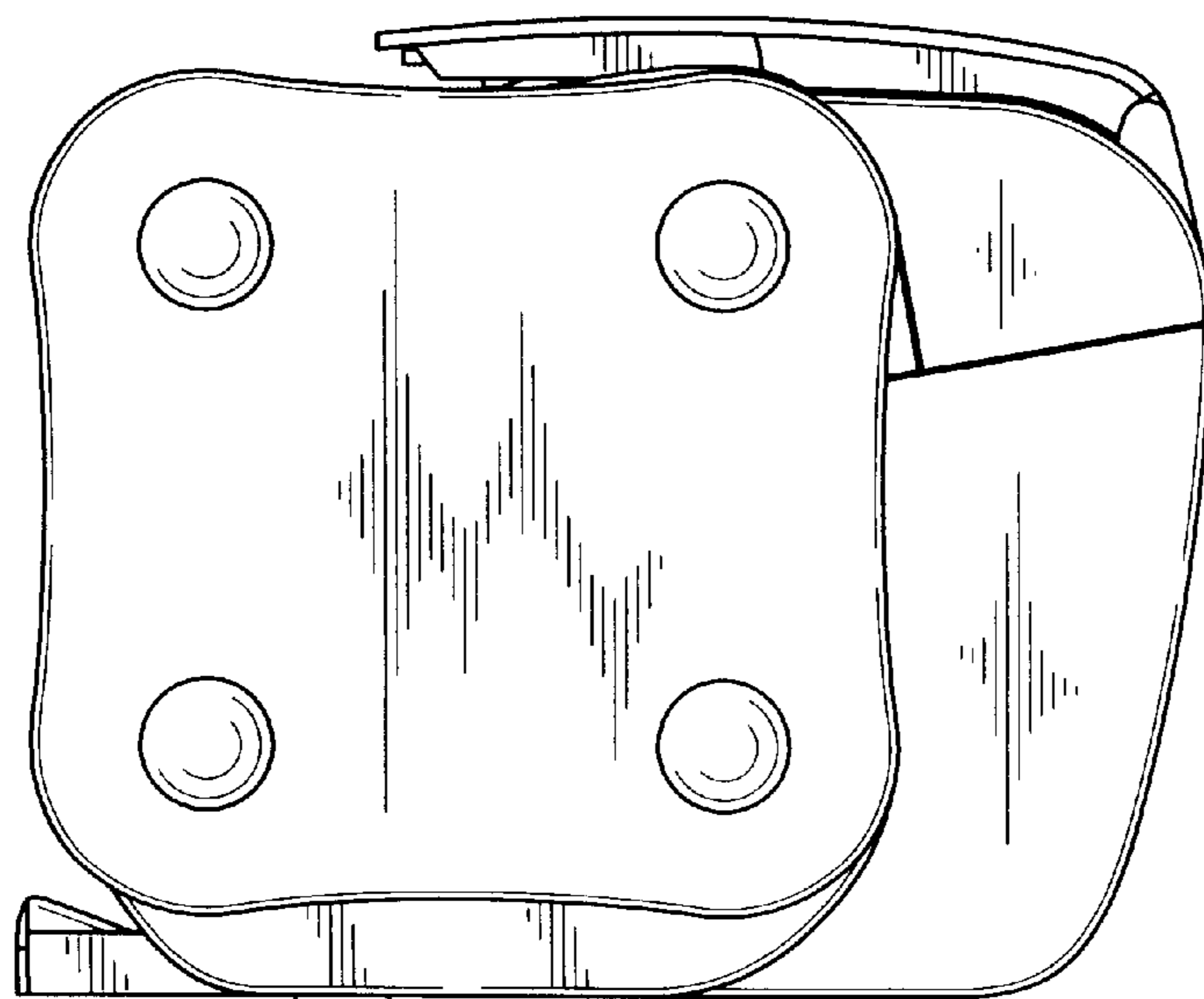

FIG. 7

