

US00D492845S1

(12) **United States Design Patent**
McElmury

(10) **Patent No.:** **US D492,845 S**
(45) **Date of Patent:** **** Jul. 13, 2004**

(54) **SOCKET CONTAINING DEVICE**
(75) **Inventor:** **Archie J. McElmury**, 5240 Keats Ave.
N., Lake Elmo, MN (US) 55042
(73) **Assignee:** **Archie J. McElmury**, Lake Elmo, MN
(US)
(**) **Term:** **14 Years**

(21) **Appl. No.:** **29/188,272**
(22) **Filed:** **Aug. 15, 2003**

(51) **LOC (7) Cl.** **03-01**
(52) **U.S. Cl.** **D3/304**
(58) **Field of Search** D99/34; D7/550.1,
D7/554.3; 206/350, 376-378, 372, 373,
815, 818, 557, 8; 211/13.1, 70.6, 70.1,
126.1, 133.6; D3/304, 307, 312, 314, 905

(56) **References Cited**

U.S. PATENT DOCUMENTS

1,671,159	A	*	5/1928	Miller et al.	206/378
2,065,341	A	*	12/1936	McNaught et al.	206/378
4,353,465	A	*	10/1982	Rado		
4,535,658	A	*	8/1985	Molinari		
4,591,817	A	*	5/1986	Miller		
4,627,315	A	*	12/1986	Lin		
4,711,353	A	*	12/1987	Rozmestor		
4,802,580	A	*	2/1989	Andersen		
4,826,021	A	*	5/1989	Burrell		
4,941,571	A	*	7/1990	Barrett		
D310,770	S	*	9/1990	Zamarripa		
D312,017	S	*	11/1990	Gould		
D316,330	S	*	4/1991	Vicento		
D319,348	S	*	8/1991	Monteleon		
5,050,733	A	*	9/1991	Brennan		
5,080,230	A	*	1/1992	Winnard		
5,154,544	A	*	10/1992	Arendt		
5,172,612	A	*	12/1992	Hansson		
5,195,636	A	*	3/1993	Wridt		
5,228,570	A	*	7/1993	Robinson		
5,259,278	A	*	11/1993	Leas		
5,284,245	A	*	2/1994	Slivon et al.		
5,313,181	A	*	5/1994	Negus		

5,316,143	A		5/1994	Horn		
5,343,181	A		8/1994	Negus		
D355,554	S	*	2/1995	Phelps		
D356,462	S	*	3/1995	Ko		
5,398,823	A		3/1995	Anders		
5,405,025	A		4/1995	Melrose		
5,407,063	A		4/1995	Warner		
D360,529	S	*	7/1995	Balzen		
5,456,359	A	*	10/1995	Horn	206/350
D364,526	S	*	11/1995	Laufenberg		
5,467,874	A		11/1995	Whitaker		
5,500,631	A		3/1996	Negus		
5,501,342	A		3/1996	Geibel		
5,511,673	A		4/1996	Folk		

(List continued on next page.)

Primary Examiner—Louis S. Zarfaz
Assistant Examiner—Deanne Levy
(74) *Attorney, Agent, or Firm*—Patterson, Thunte, Skaar & Christensen, P.A.

(57) **CLAIM**

I claim the ornamental design for socket containing device, as shown and described.

DESCRIPTION

FIG. 1 is a front side perspective view of a first embodiment of a socket containing device showing my new design; FIG. 2 is a top plan view thereof; FIG. 3 is a bottom plan view thereof; FIG. 4 is a front-end view thereof; FIG. 5 is a back-end view thereof; FIG. 6 is a first side view thereof; FIG. 7 is a second side view thereof; FIG. 8 is a front-end cross-section taken along line 8-8 of FIG. 1; FIG. 9 is a back-end cross-section taken along line 9-9 of FIG. 1; and, FIG. 10 a front side perspective view of a second embodiment of a socket containing device showing my new design. The broken line showing of environmental subject matter is for illustrative purposes only and forms no part of the claimed design.

1 Claim, 6 Drawing Sheets

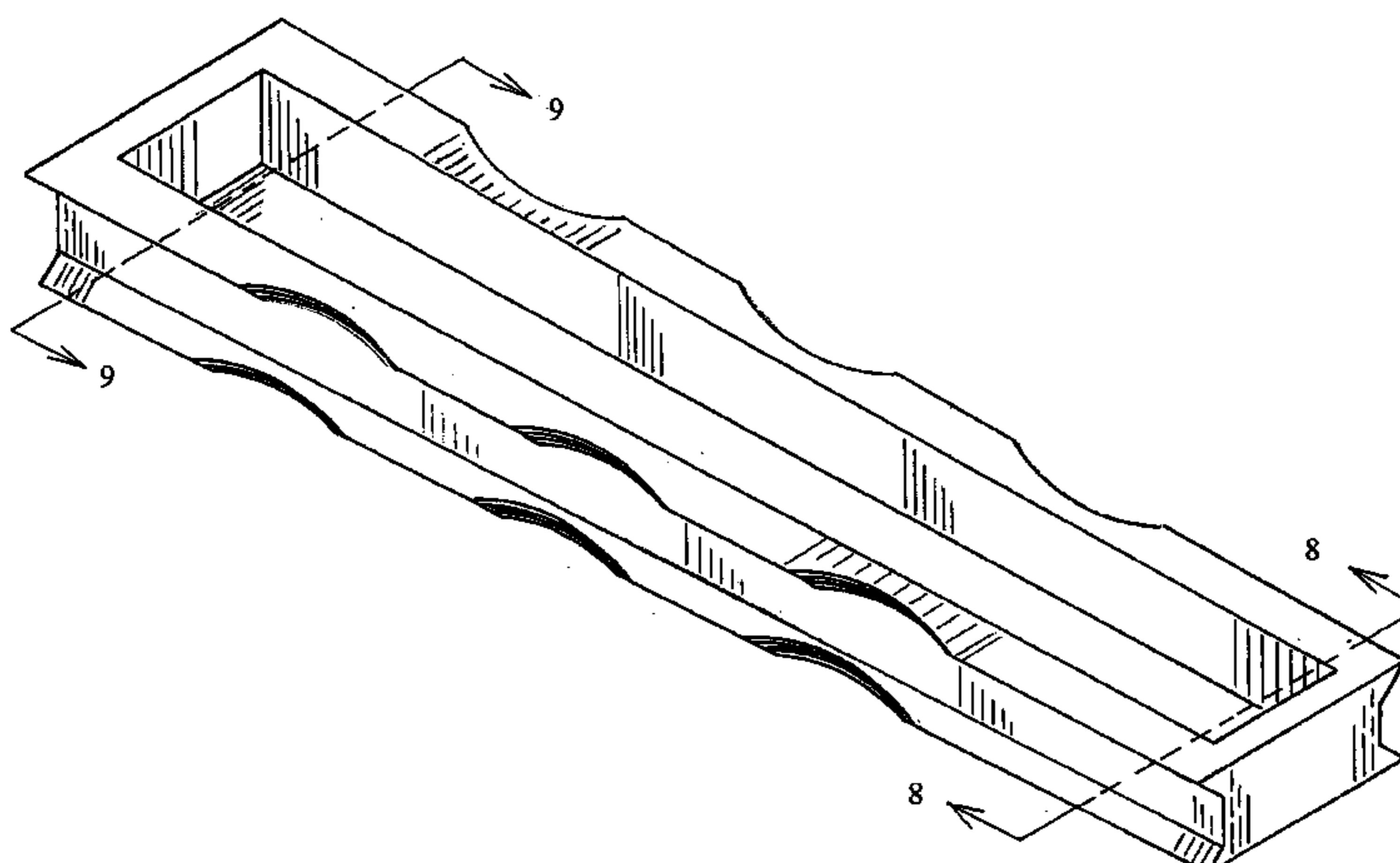

US D492,845 S

Page 2

U.S. PATENT DOCUMENTS

5,544,747 A *	8/1996	Horn	206/818	6,109,491 A	8/2000	Aronson
5,560,480 A	10/1996	Singleton			6,168,018 B1	1/2001	Ramsey
5,573,116 A	11/1996	Zink			D443,160 S *	6/2001	Ernst
5,743,394 A	4/1998	Martin			6,250,466 B1	6/2001	Ernst
5,743,395 A	4/1998	Backer			6,364,109 B1	4/2002	Blackwell
5,799,789 A	9/1998	Ritchie			6,390,298 B1	5/2002	Garro
D403,860 S *	1/1999	Ritchie			6,450,338 B1	9/2002	Chen
5,855,285 A	1/1999	Laird			6,494,329 B1	12/2002	Dembicks
5,901,620 A	5/1999	Arnold			6,508,360 B1	1/2003	Chen
5,931,318 A *	8/1999	Shauo	211/70.6	2002/0121492 A1 *	9/2002	McConnell
6,006,906 A	12/1999	Winnard			2002/0130231 A1 *	9/2002	Winnard
6,070,745 A	6/2000	Dembicks			2003/0019775 A1 *	1/2003	Ernst
6,092,655 A	7/2000	Ernst			2003/0024837 A1 *	2/2003	Chen
6,092,656 A	7/2000	Ernst			2003/0025056 A1 *	2/2003	Atchley
6,095,329 A	8/2000	Kao			2003/0029284 A1 *	2/2003	Malchus
6,098,799 A	8/2000	Lee					

* cited by examiner

FIG. 1

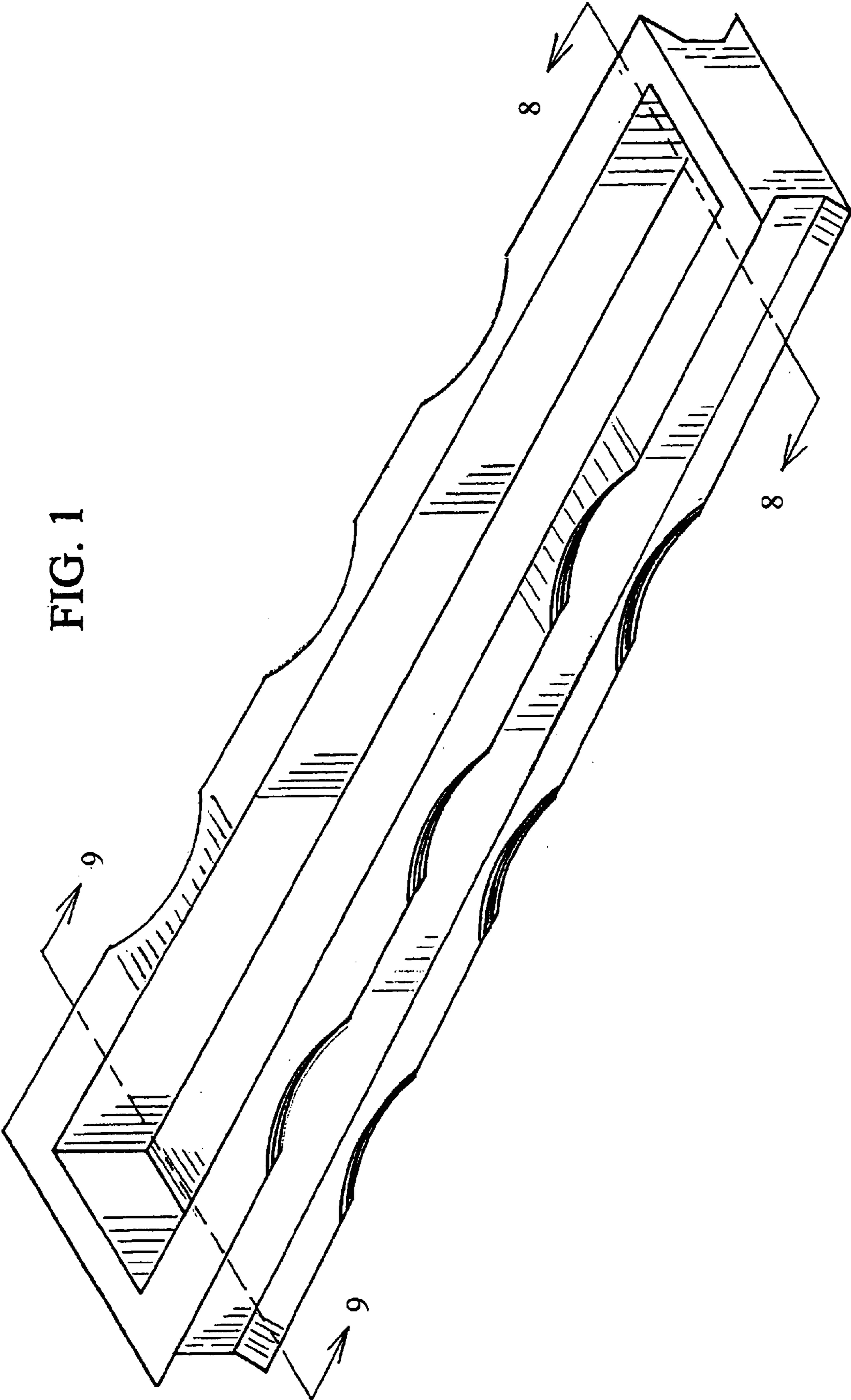

FIG. 2

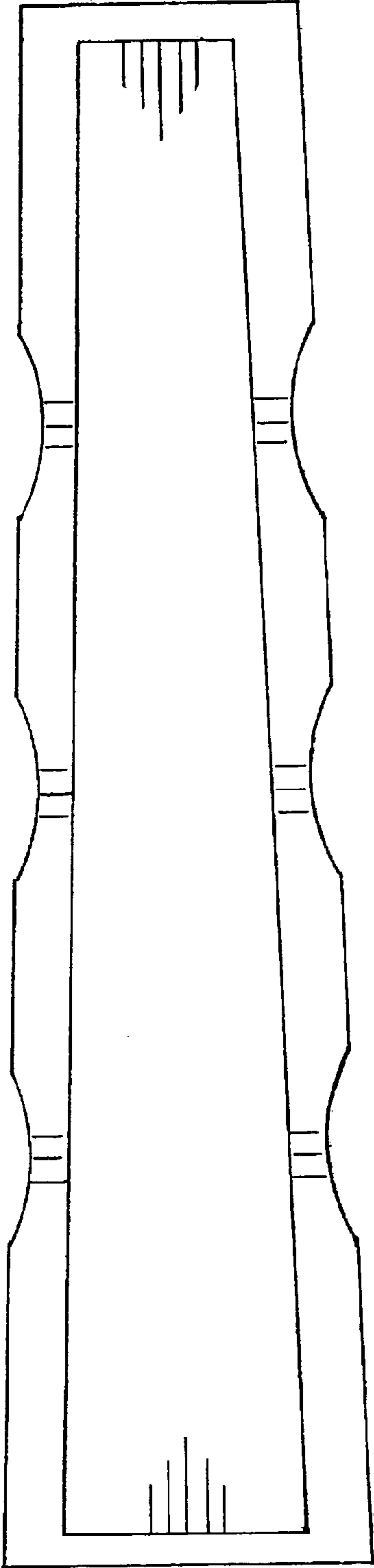

FIG. 3

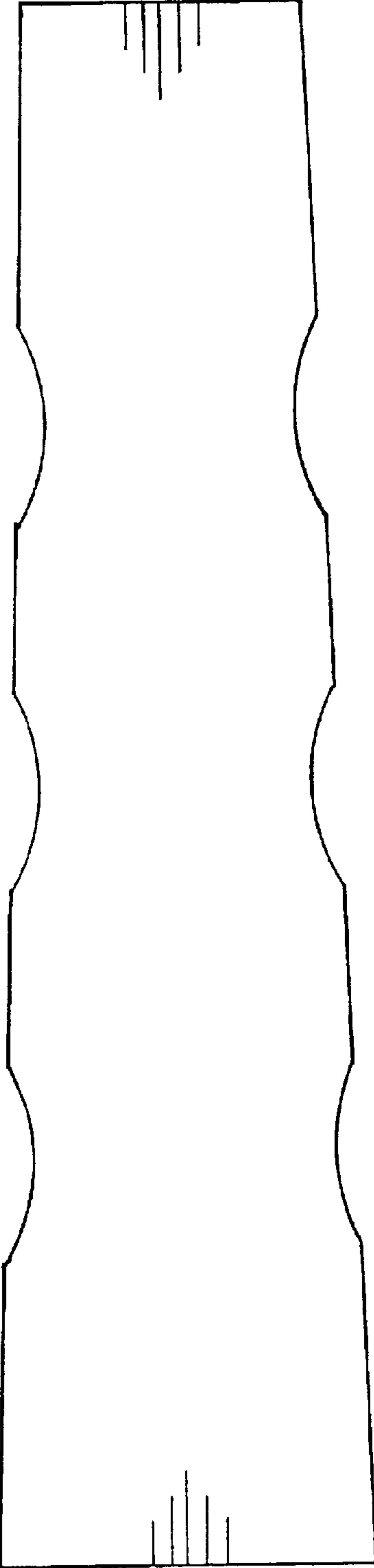

FIG. 5

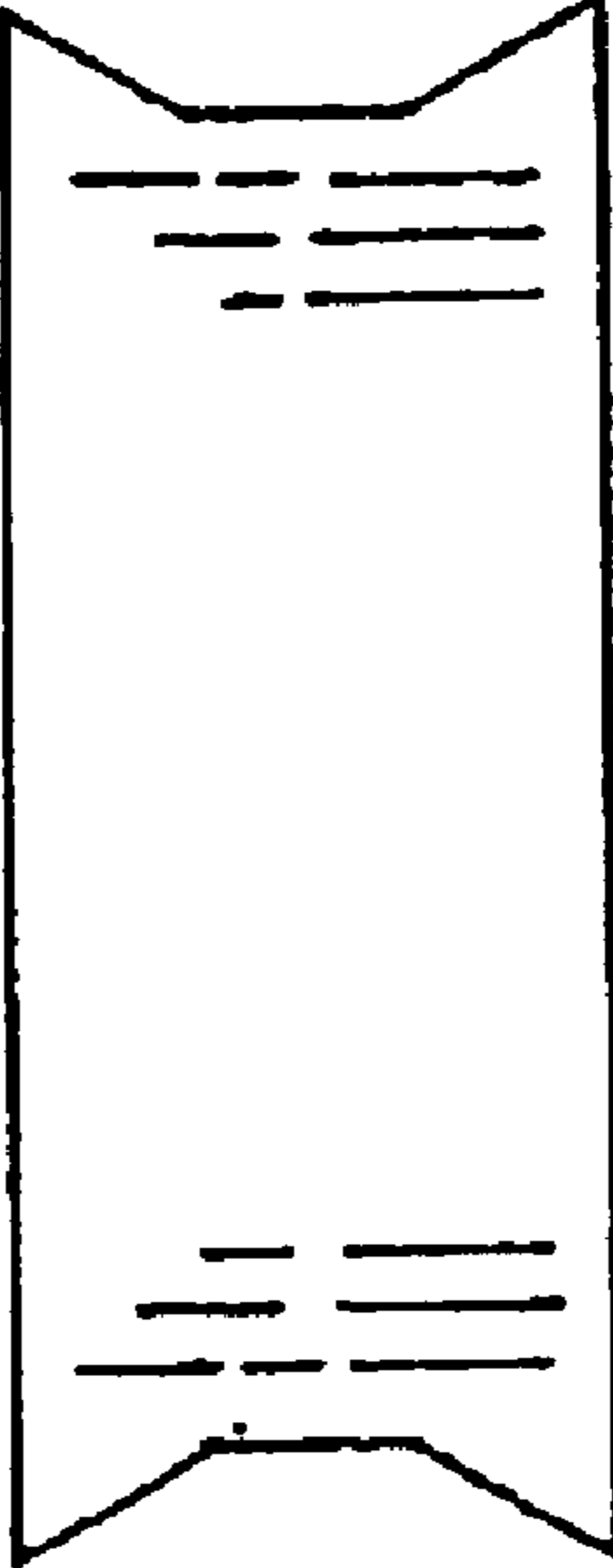

FIG. 4

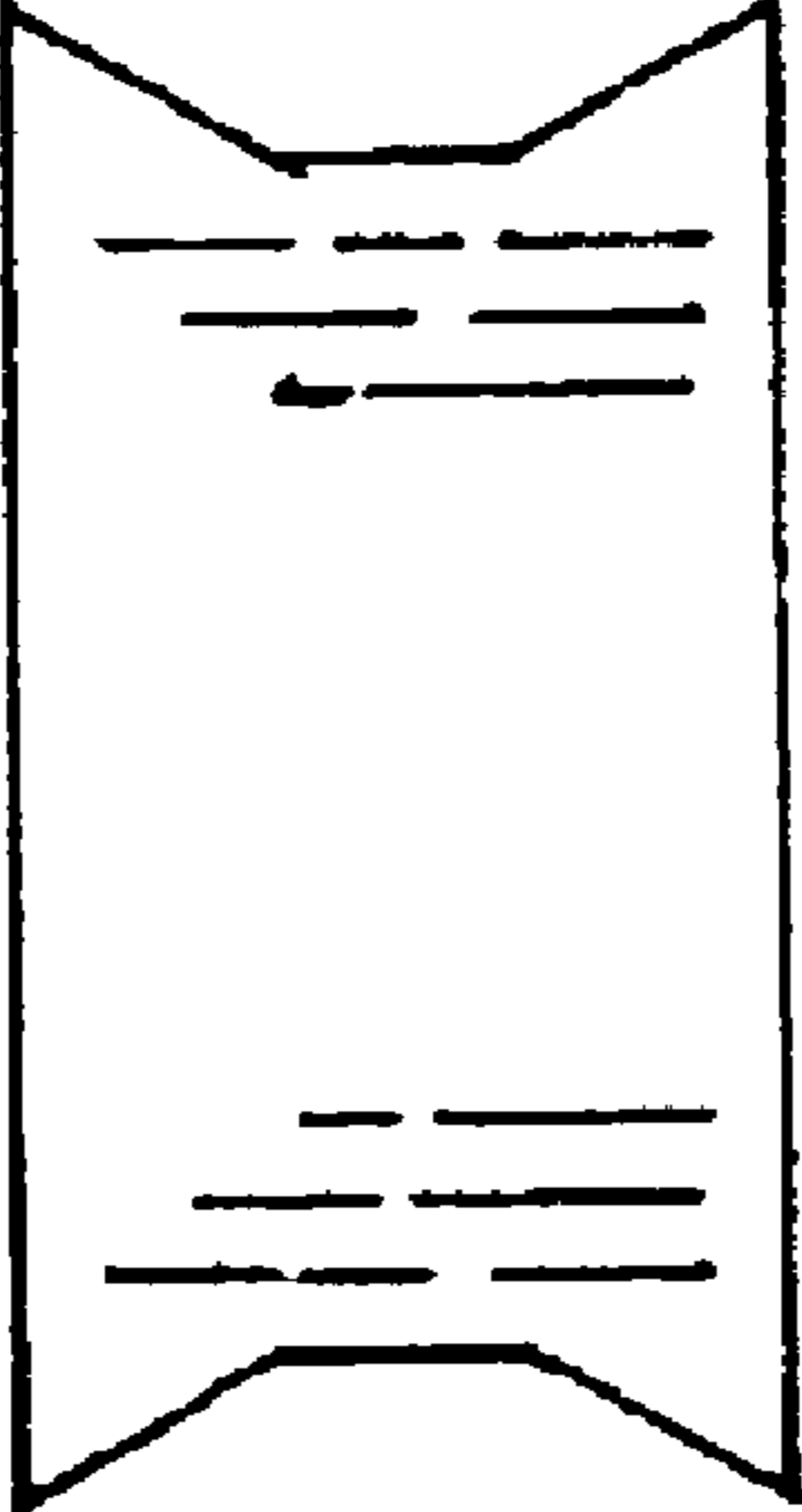

FIG. 6

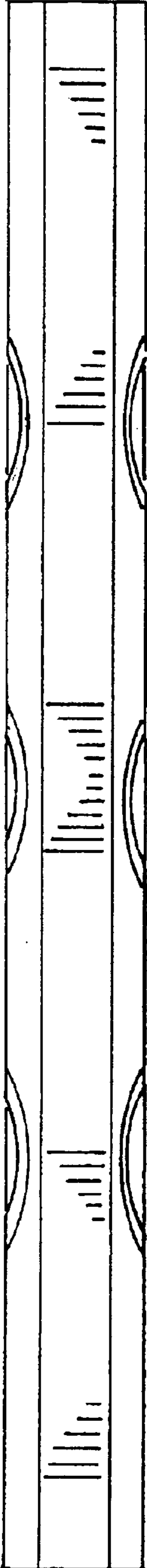

FIG. 7

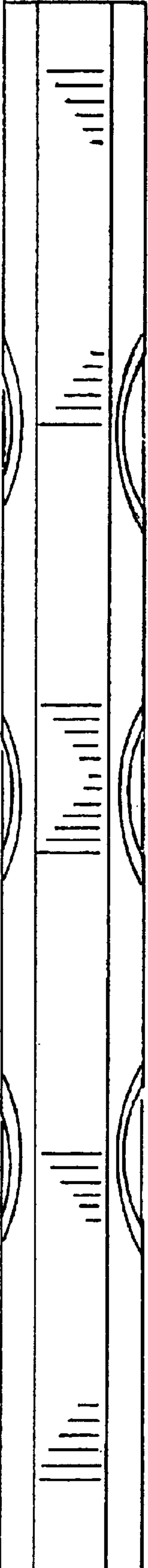
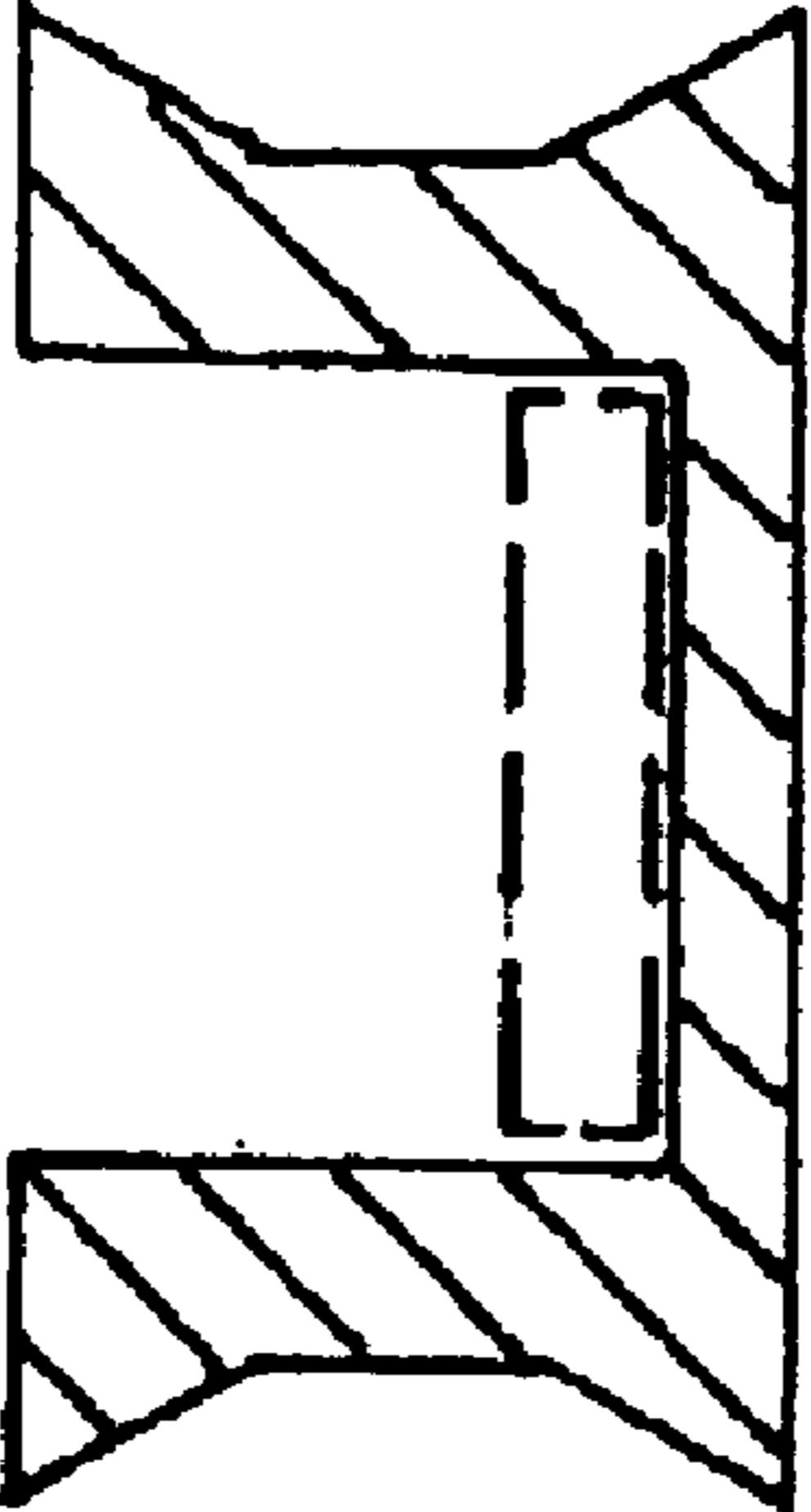

FIG. 9



FIG. 8



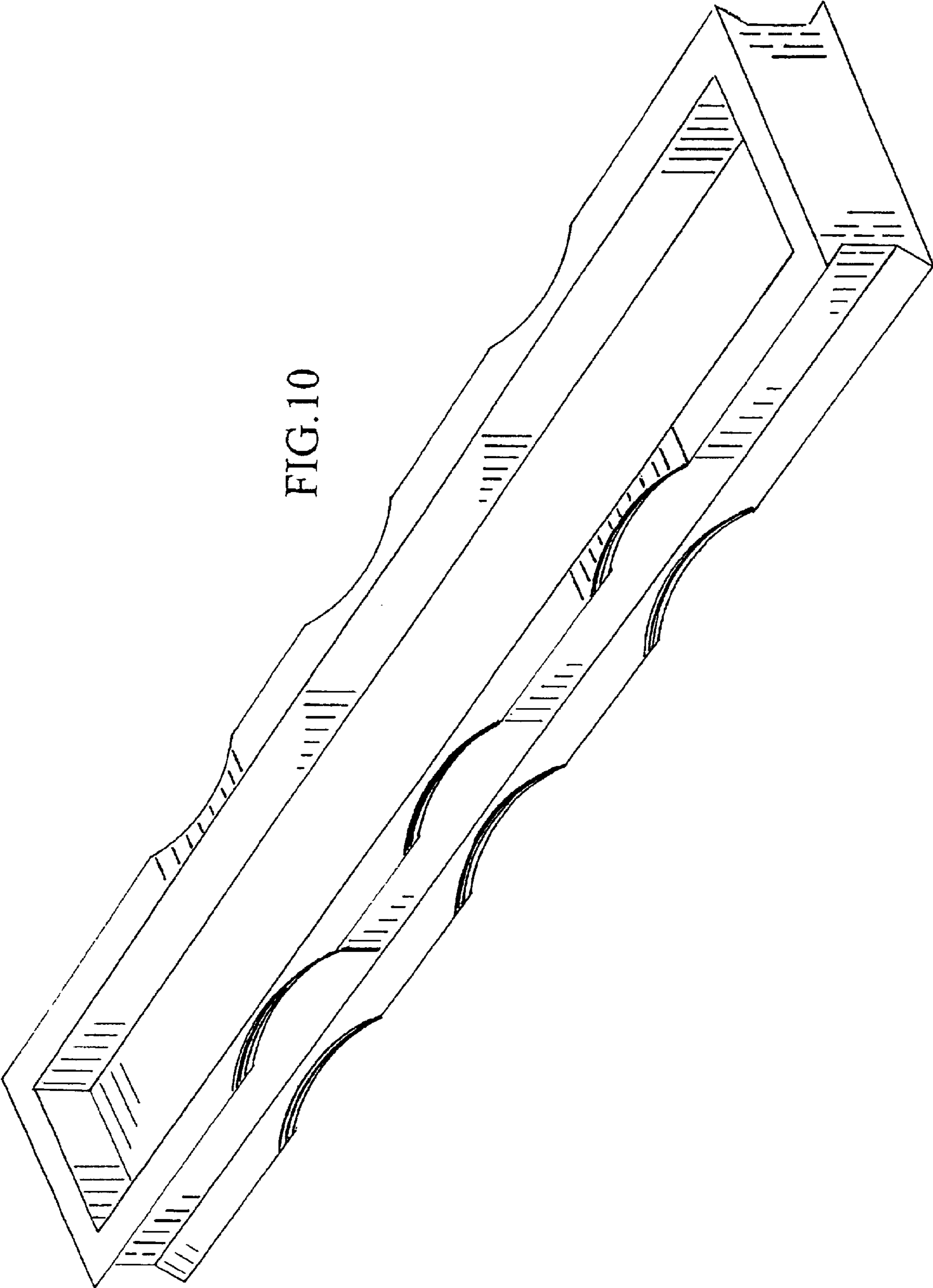

FIG.10