

US00D492666S1

(12) **United States Design Patent** (10) **Patent No.:** **US D492,666 S**
Wiener (45) **Date of Patent:** **** Jul. 6, 2004**

(54) **ELEMENT OF AN AUDIO SPEAKER ENCLOSURE**

(75) Inventor: **David Wiener**, Park City, UT (US)

(73) Assignee: **SoundTube Entertainment, Inc.**, Park City, UT (US)

(**) Term: **14 Years**

(21) Appl. No.: **29/170,113**

(22) Filed: **Oct. 30, 2002**

Related U.S. Application Data

(62) Division of application No. 29/153,553, filed on Jan. 9, 2002.

(51) **LOC (7) Cl.** **14-01**

(52) **U.S. Cl.** **D14/221; D14/207**

(58) **Field of Search** D7/519-594, 597; D14/204, 207, 209-216, 356; 181/144-148, 150, 153, 157, 198-199; 381/300-302, 306, 333, 345, 361-364, 386-388; 222/548

(56) **References Cited**

U.S. PATENT DOCUMENTS

225,785 A * 3/1880 Beattie D7/597
D67,624 S * 6/1925 Taylor D14/212

3,494,515 A * 2/1970 Fattori D7/597
D218,593 S * 9/1970 Hart D9/597
D221,794 S * 9/1971 Apple D7/597
D255,532 S * 6/1980 Saffell D7/597
5,319,164 A * 6/1994 Shen 181/150
D419,560 S * 1/2000 Cheung D14/216

* cited by examiner

Primary Examiner—Nanda Bondade

(74) *Attorney, Agent, or Firm*—Gordon & Jacobson, P.C.

(57) **CLAIM**

The ornamental design for an element of an audio speaker enclosure, as shown and described.

DESCRIPTION

FIG. 1 is a side elevational view of an element of audio speaker enclosure showing my new design;
FIG. 2 is a top view thereof;
FIG. 3 is a top perspective view thereof;
FIG. 4 is a bottom perspective view thereof;
FIG. 5 is a side elevational view of a second embodiment of FIG. 1;
FIG. 6 is a top view of FIG. 5;
FIG. 7 is a bottom perspective view of FIG. 5; and,
FIG. 8 is a top perspective view of FIG. 5.
The broken line showing on FIGS. 1-8 is for illustrative purpose only and forms no part of the claimed design.

1 Claim, 2 Drawing Sheets

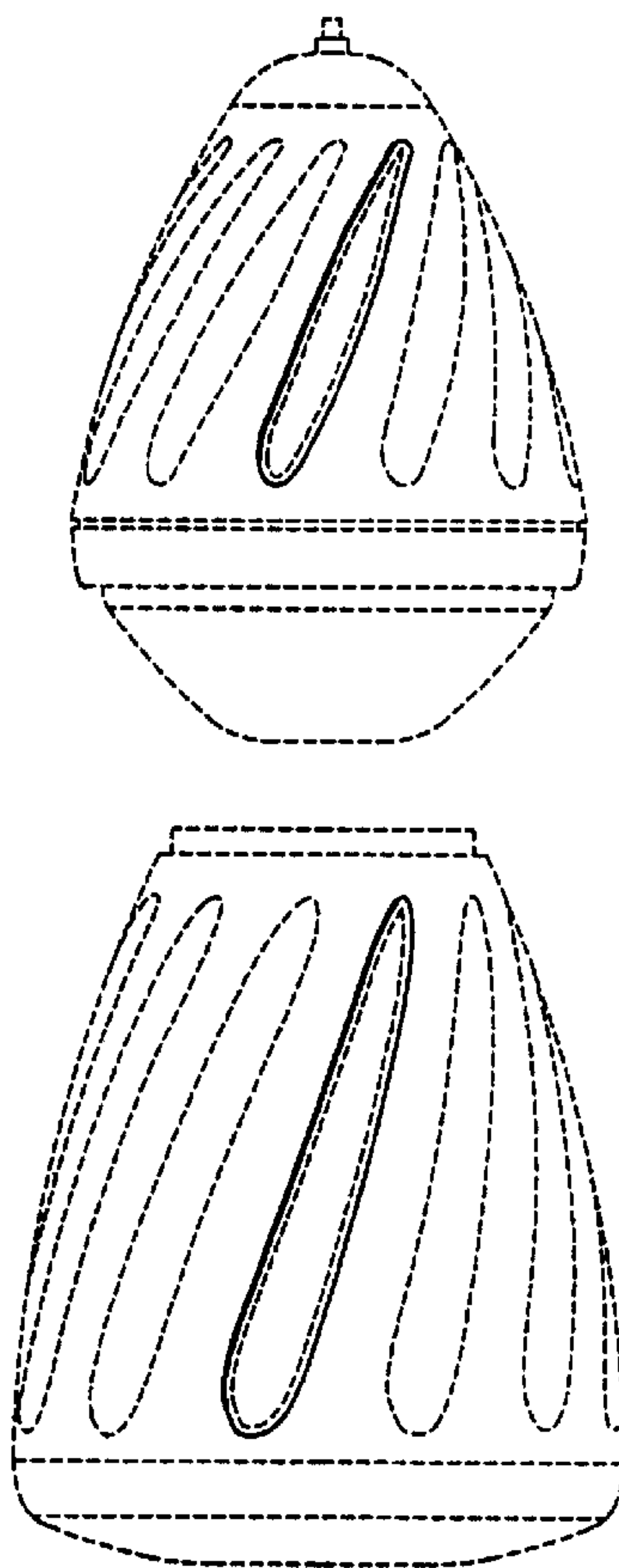

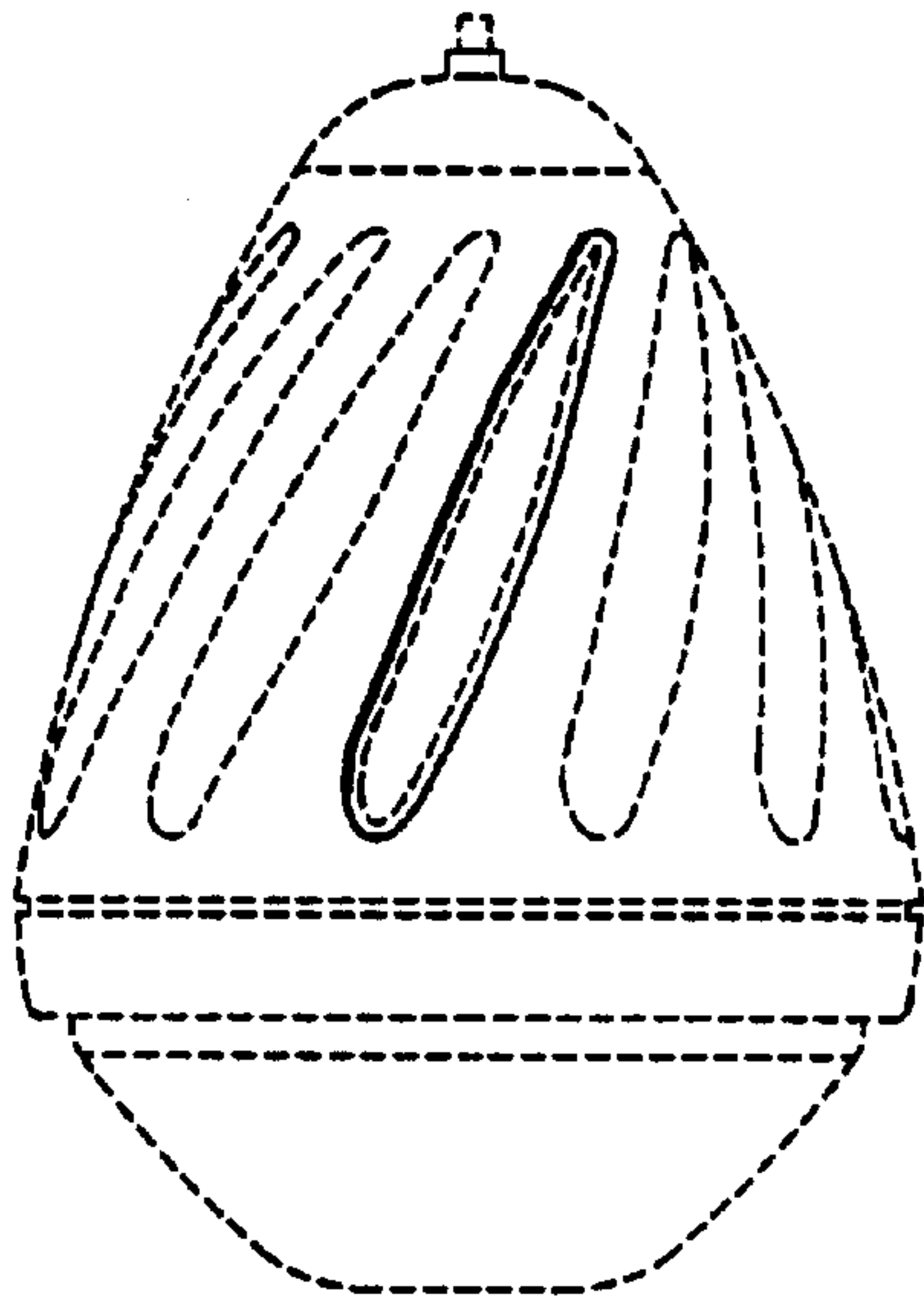

FIG. 1

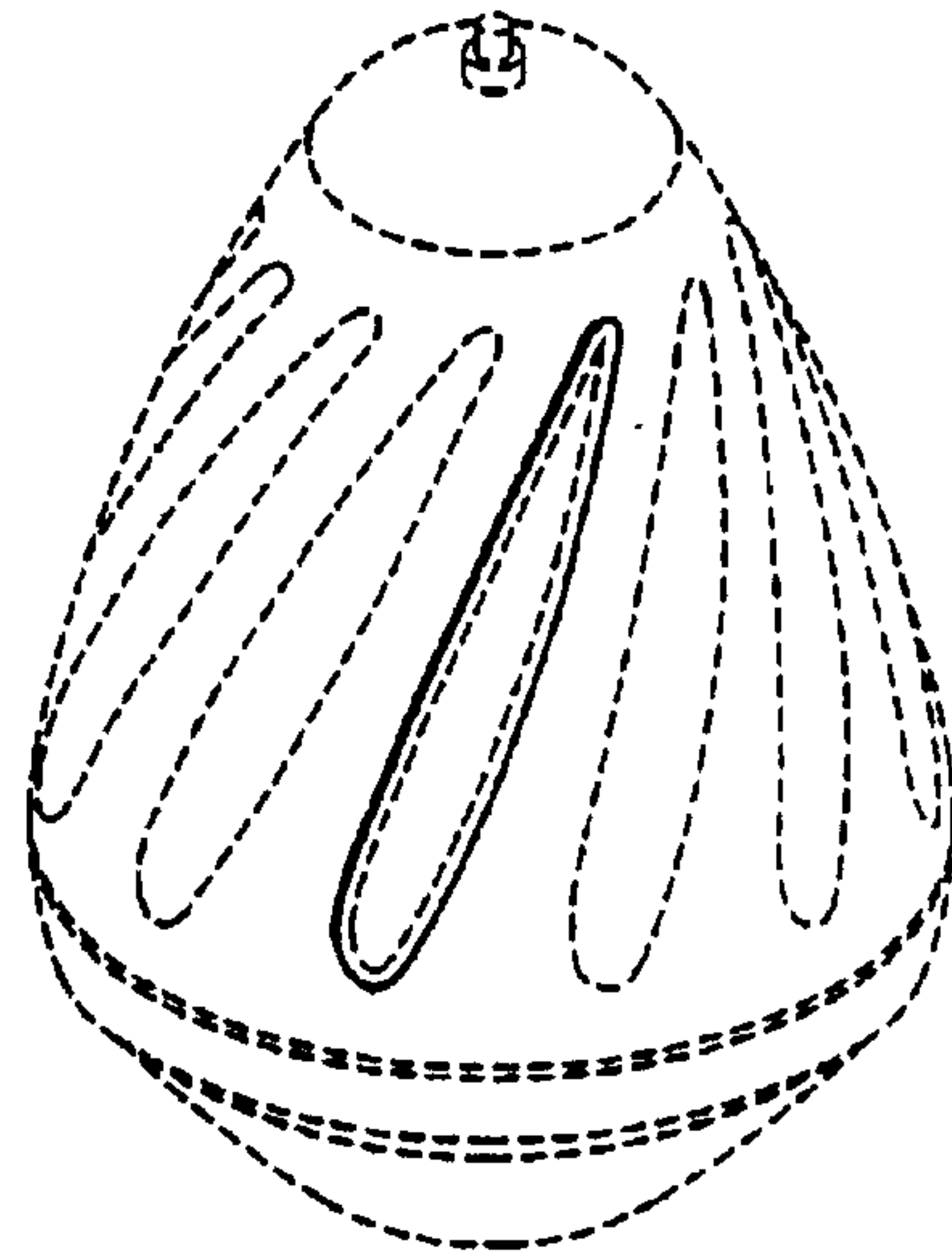

FIG. 3

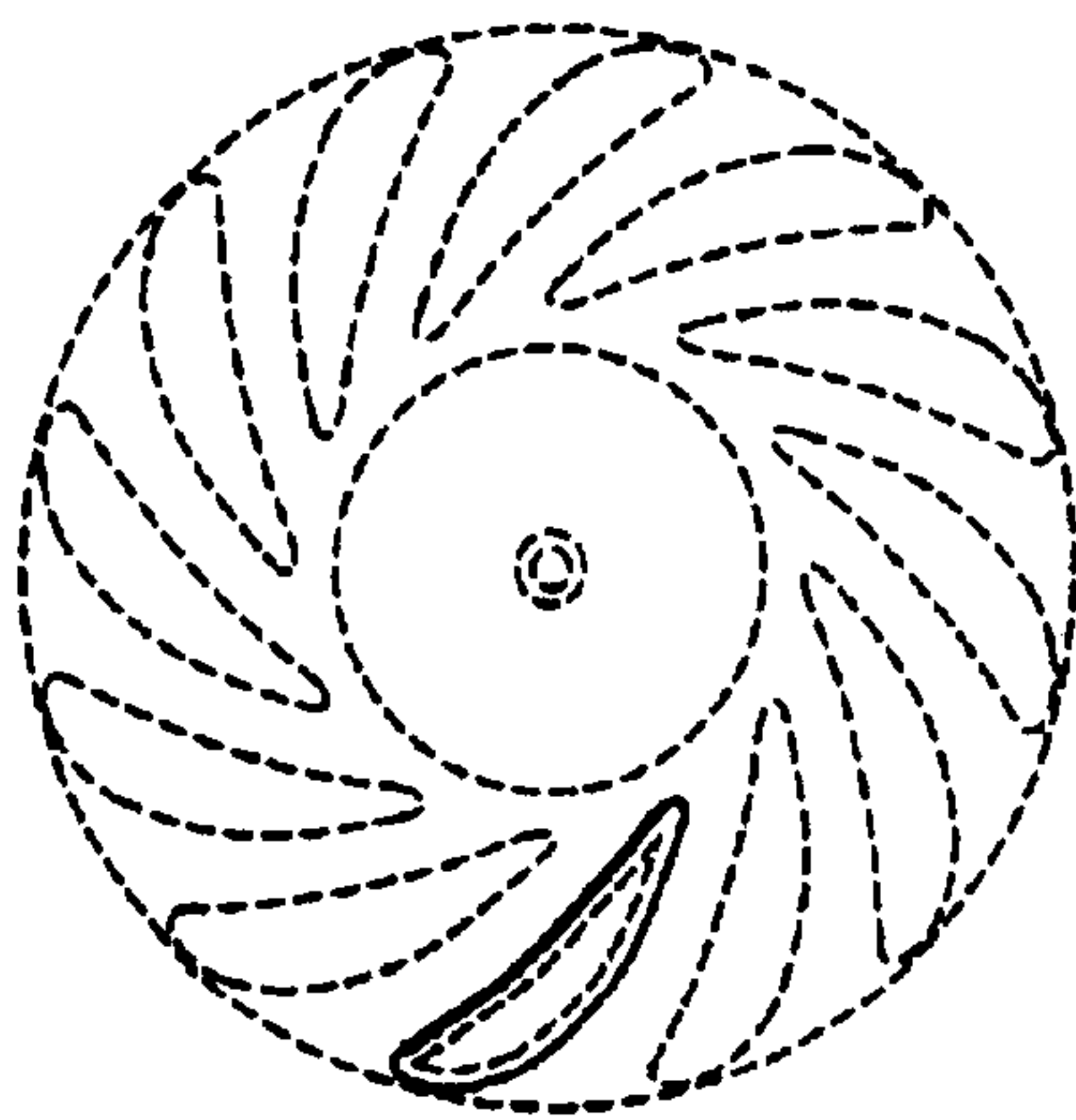

FIG. 2

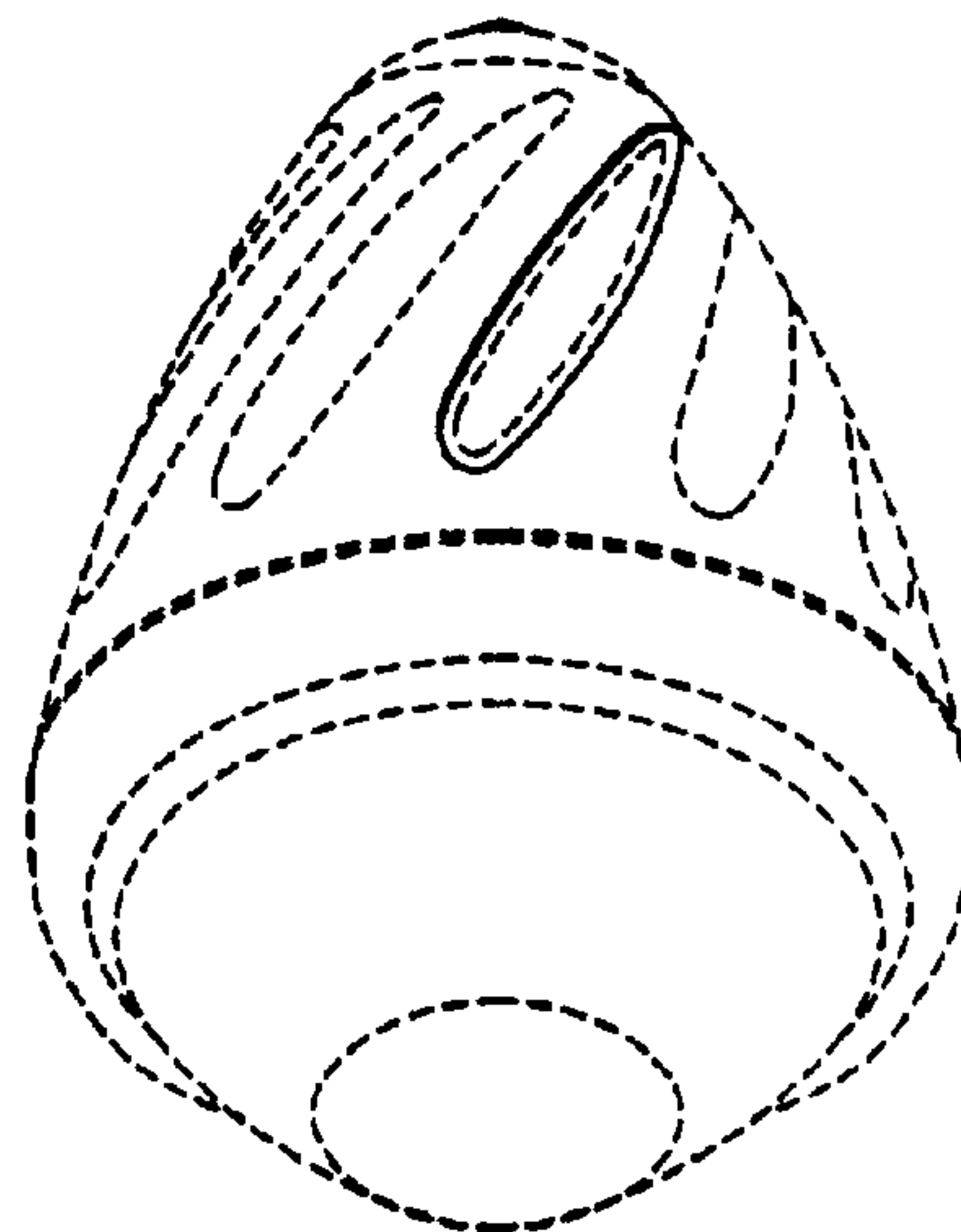

FIG. 4

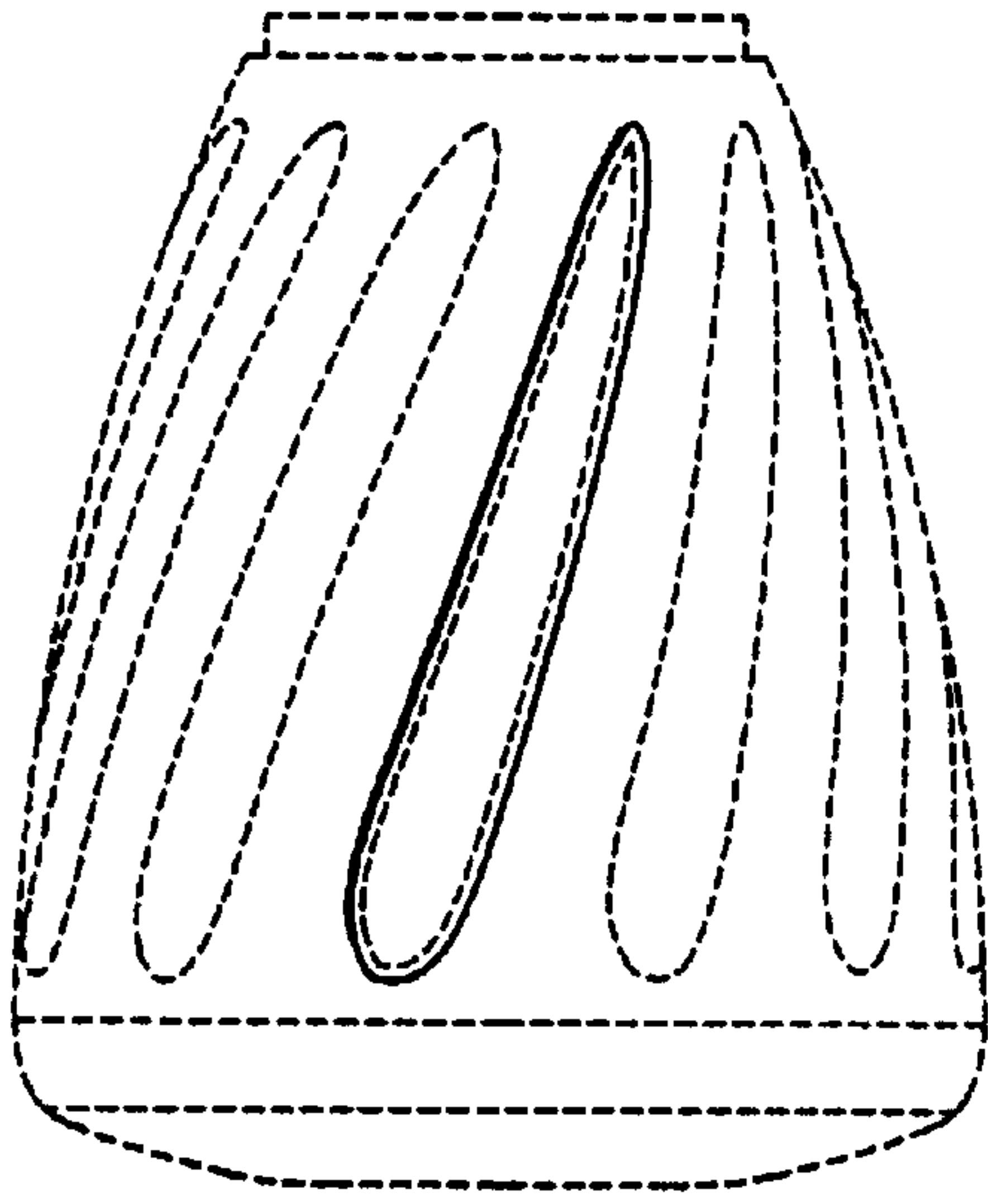

FIG. 5

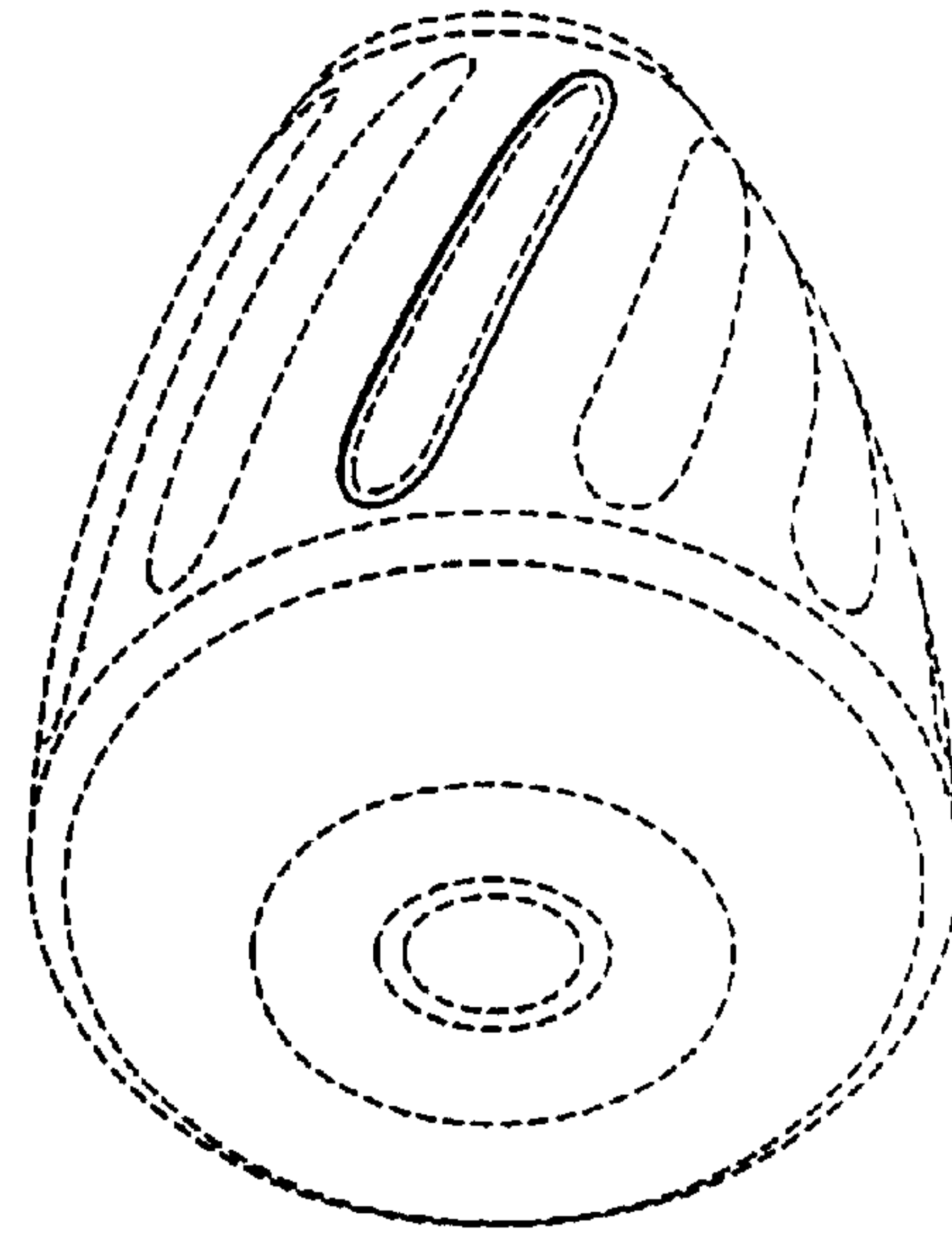

FIG. 7

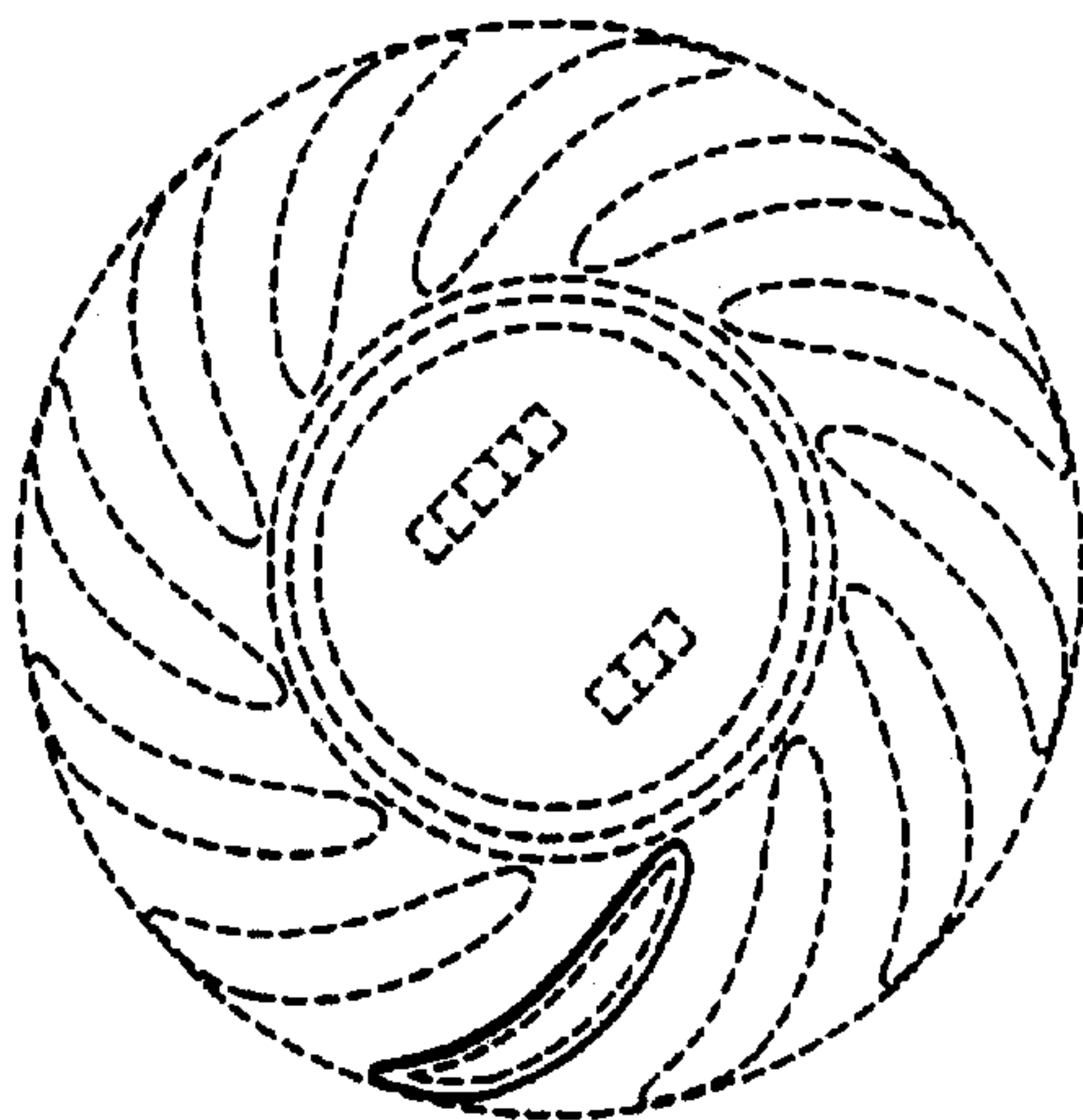

FIG. 6

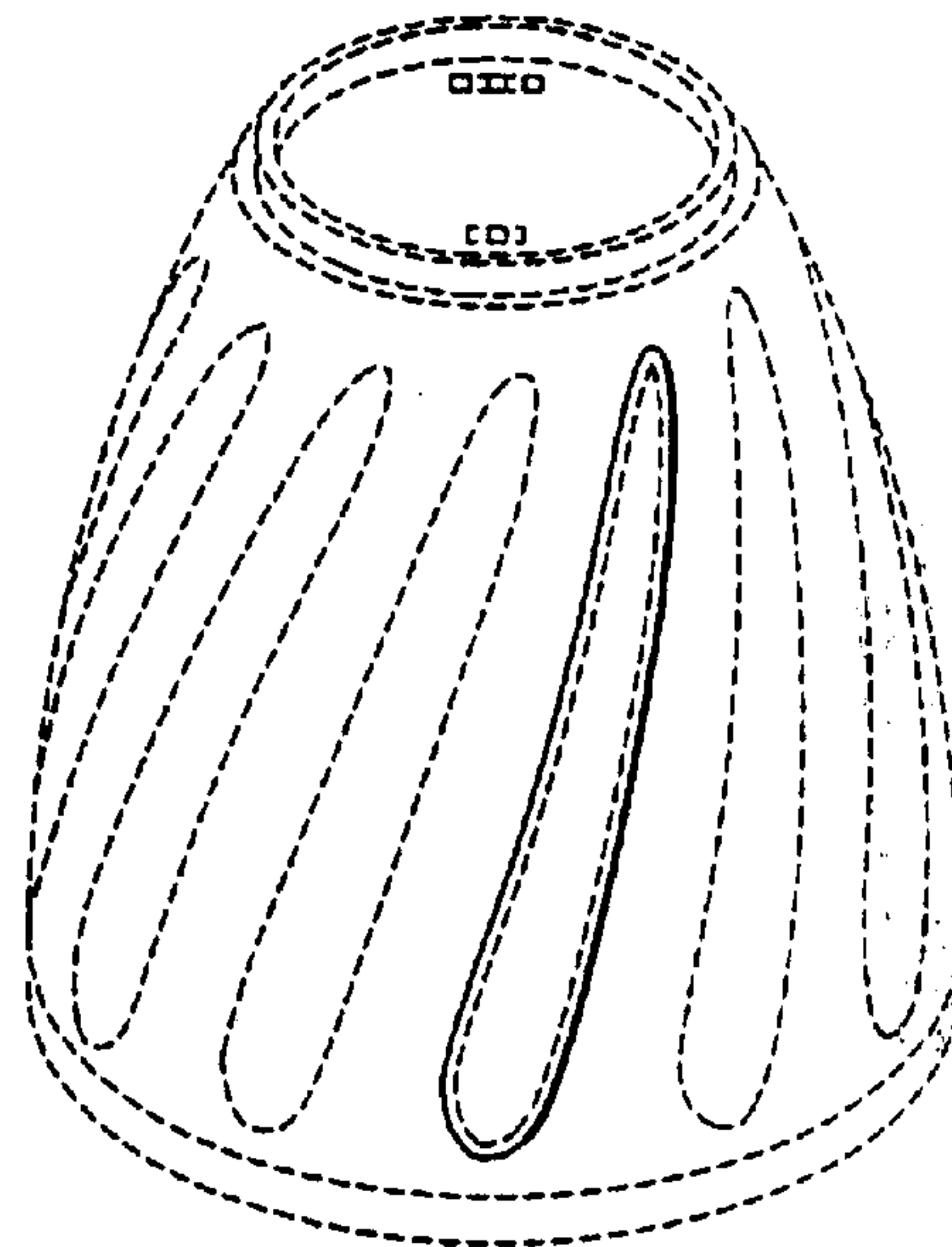

FIG. 8