

US00D492633S1

(12) **United States Design Patent** (10) **Patent No.:** **US D492,633 S**
Wales (45) **Date of Patent:** **** Jul. 6, 2004**

- (54) **SNAP-ON LICENSE PLATE EMBLEMS KIT**
 (76) Inventor: **Mark A. Wales**, 1553 Washington Pike,
 Wellsburg, WV (US) 26070
 (**) Term: **14 Years**
 (21) Appl. No.: **29/190,038**
 (22) Filed: **Sep. 15, 2003**
 (51) **LOC (7) Cl.** **12-16**
 (52) **U.S. Cl.** **D12/193**
 (58) **Field of Search** D12/193, 400,
 D12/153; D6/300–303, 310–314; 40/200–203,
 207–216; D8/305, 310, 397

(56) **References Cited**

U.S. PATENT DOCUMENTS

4,182,062 A	1/1980	Krokos et al.	40/209
4,691,457 A	9/1987	Peroni	40/20
5,027,537 A	7/1991	Freeman et al.	40/210
D319,297 S *	8/1991	Hardman	D23/251
5,392,619 A	2/1995	Dunaway	40/202 X
5,404,664 A	4/1995	Brooks et al.	40/202
D365,077 S *	12/1995	Lee	D12/193
D366,236 S *	1/1996	Chu	D12/193
D400,422 S *	11/1998	Dennison et al.	D8/305
D426,137 S *	6/2000	Ball et al.	D8/305
D428,843 S *	8/2000	Steinhagen	D12/193
D429,683 S *	8/2000	Ball et al.	D12/400
D446,759 S *	8/2001	Leu	D12/193
6,381,886 B1	5/2002	Chou	40/210 X
D464,301 S *	10/2002	Ohm	D12/193

* cited by examiner

Primary Examiner—Stacia Cadmus

(74) *Attorney, Agent, or Firm*—Donald R. Schoonover

(57) **CLAIM**

I claim the ornamental design for a snap-on license plate emblems kit, as shown and described.

DESCRIPTION

FIG. 1 is a front, top and right side perspective view of a snap-on license plate emblems kit showing a football portion of my new design;

FIG. 2 is a rear, top and right side perspective view of the football portion thereof;

FIG. 3 is a front elevational view of the football portion thereof;

FIG. 4 is a rear elevational view of the football portion thereof;

FIG. 5 is a top plan view of the football portion thereof, the bottom plan view thereof being a mirror image thereof;

FIG. 6 is a right side elevational view of the football portion thereof, the left side elevational view thereof being a mirror image thereof;

FIG. 7 is a cross-sectional view thereof taken along line 7—7 of FIG. 5;

FIG. 8 is a reduced perspective view showing the snap-on license plate emblems kit in use; the broken lines depict environmental structure for illustrative purposes only and form no part of the claimed design;

FIG. 9 is a front, top and right side perspective view of a basketball portion thereof;

FIG. 10 is a front elevational view of the basketball portion thereof;

FIG. 11 is a right side elevational view of the basketball, soccerball and baseball portions thereof, the top plan view and bottom plan view thereof being identical thereto, and the left side elevational view being a mirror image thereof;

FIG. 12 is a rear elevational view of the basketball, soccerball and baseball portions thereof;

FIG. 13 is a front, top and right side perspective view of the soccerball portion thereof;

FIG. 14 is a front elevational view of the soccerball portion thereof;

FIG. 15 is a front, top and right side perspective view of the baseball portion thereof; and,

FIG. 16 is a front elevational view of the baseball portion thereof.

1 Claim, 5 Drawing Sheets

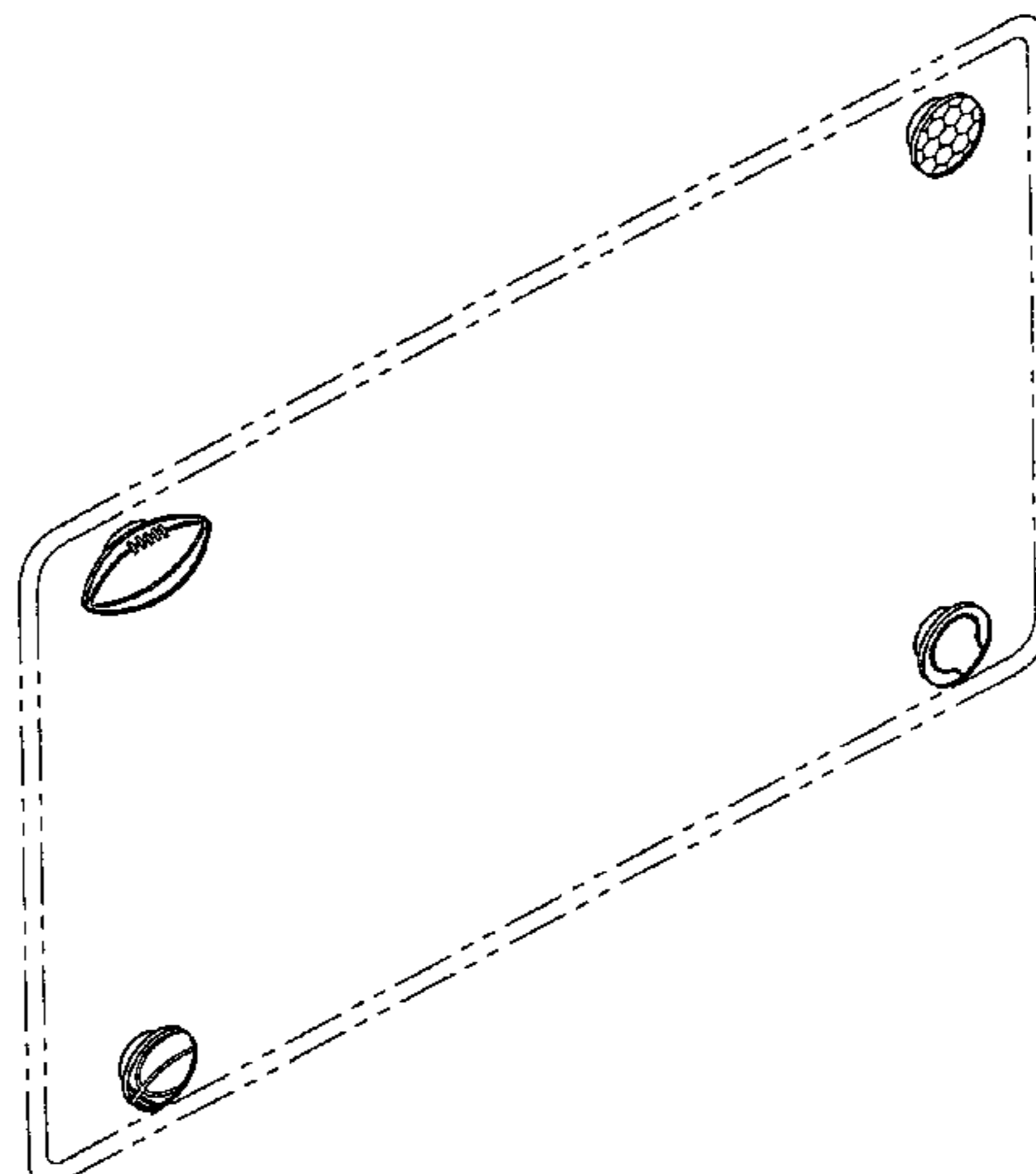

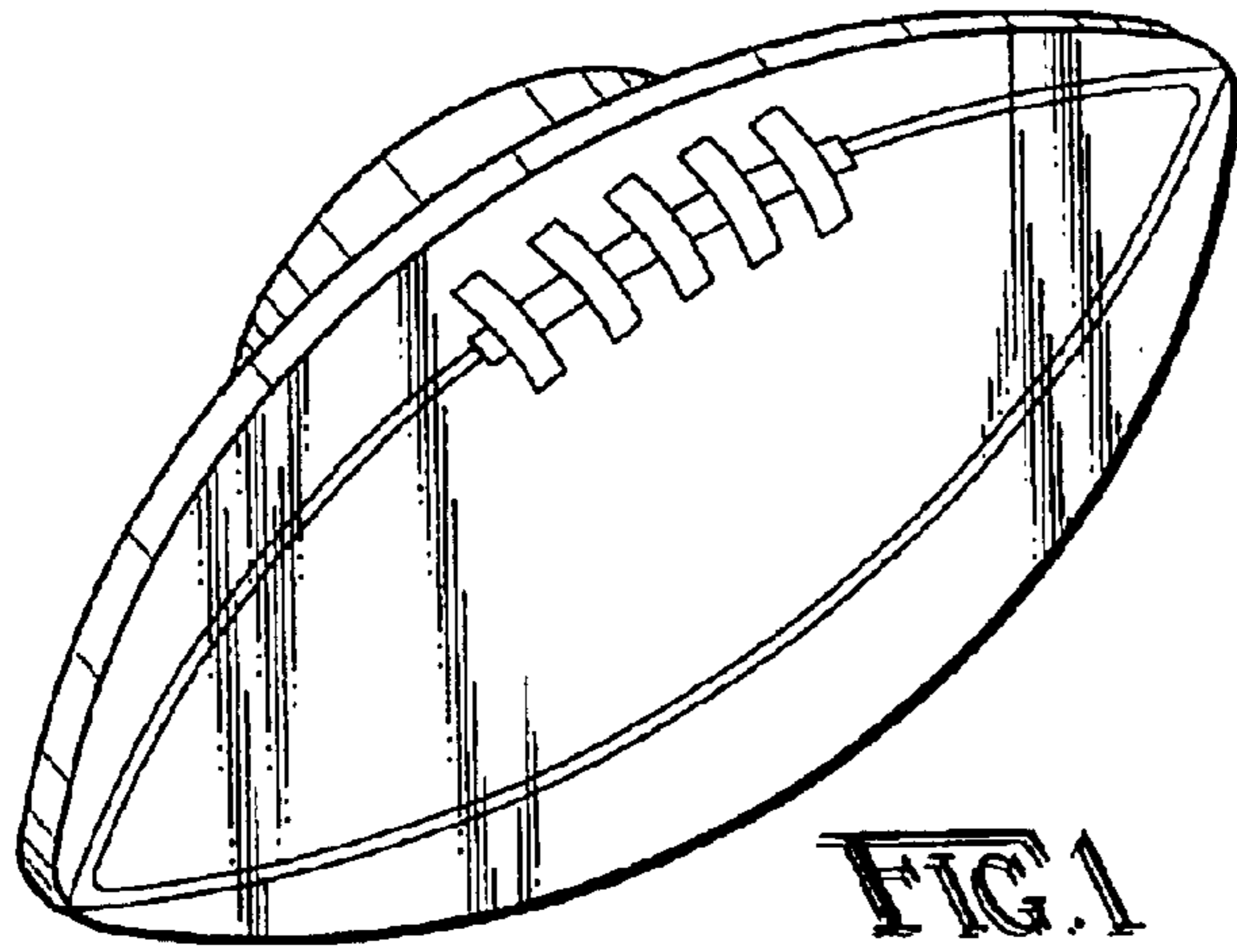

FIG. 1

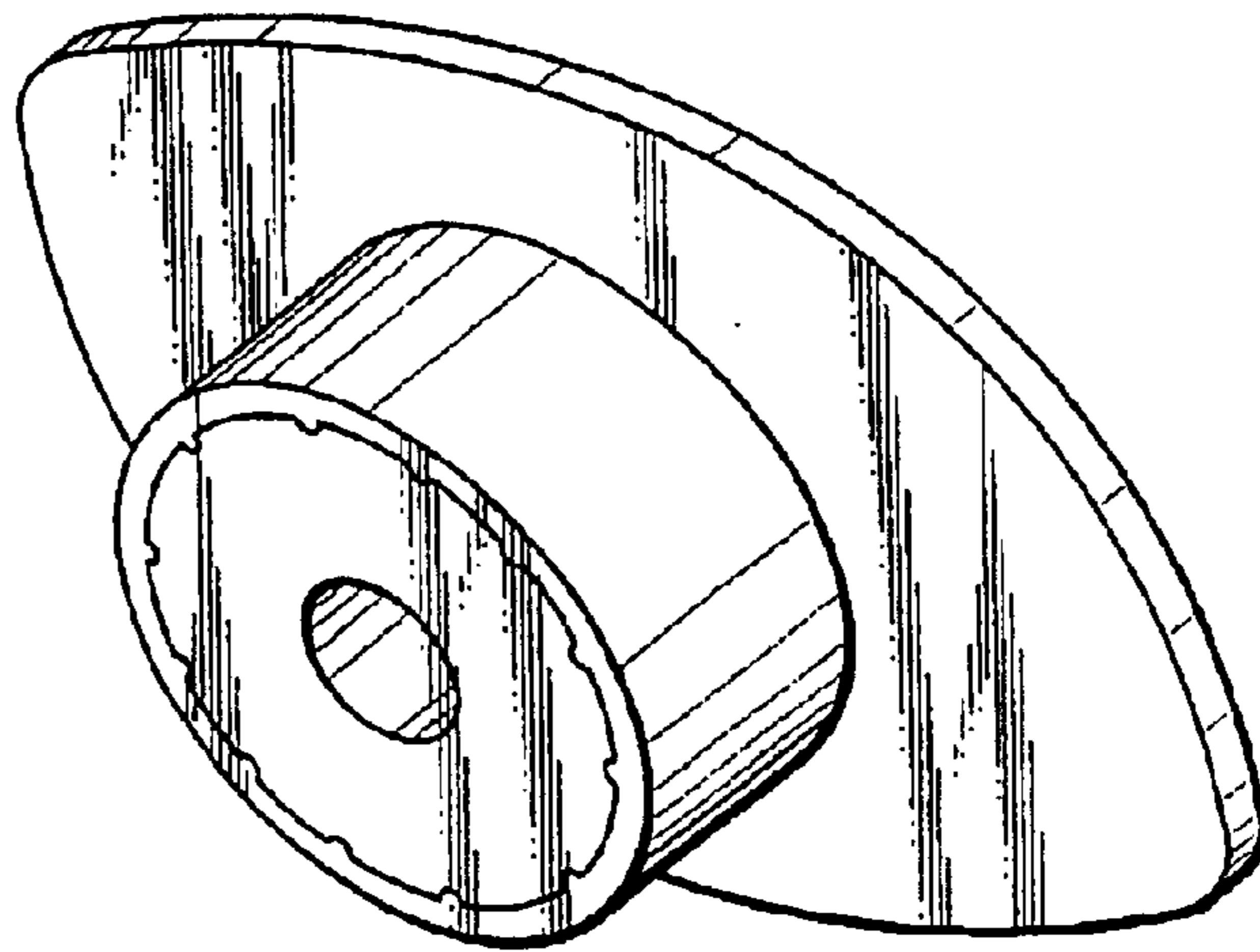

FIG. 2

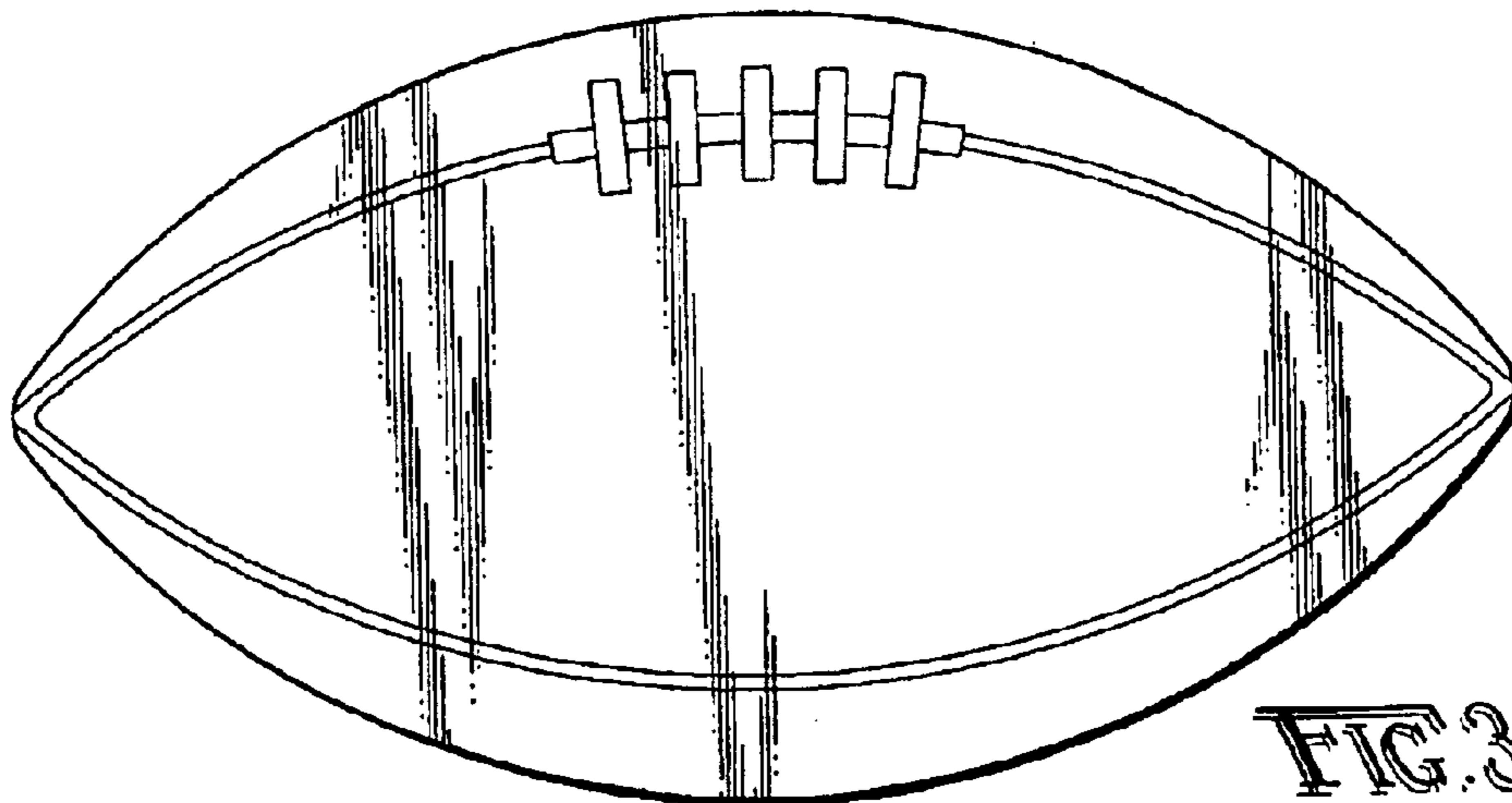
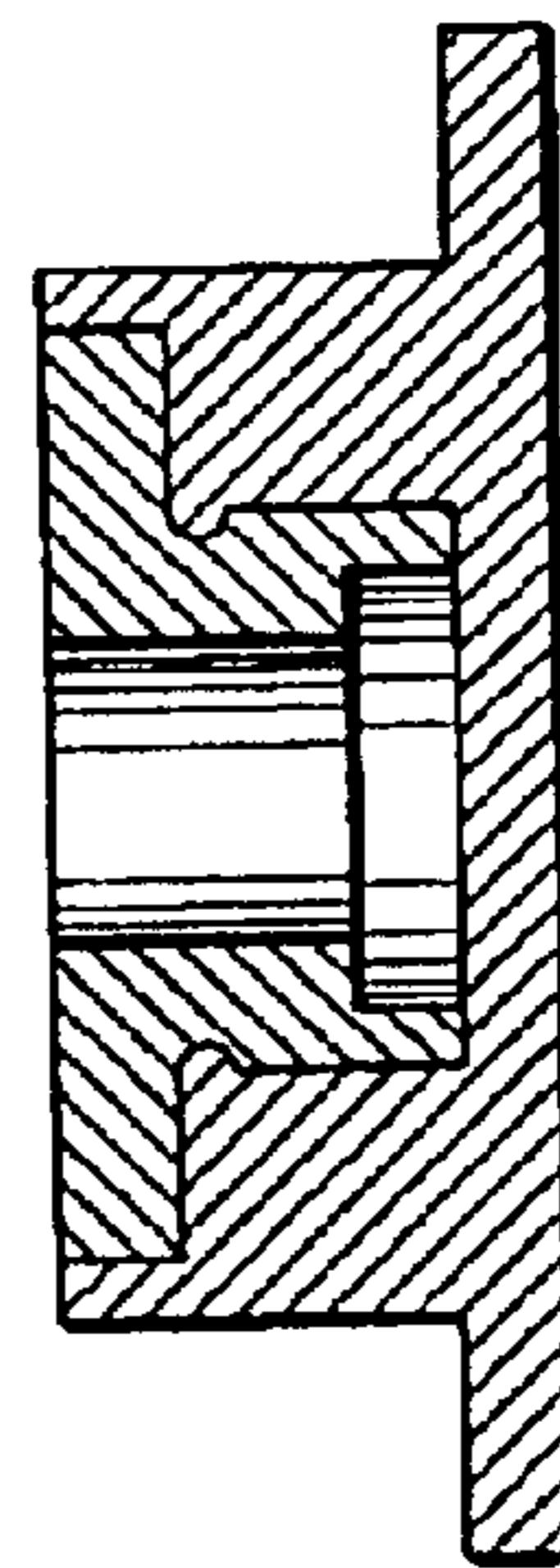
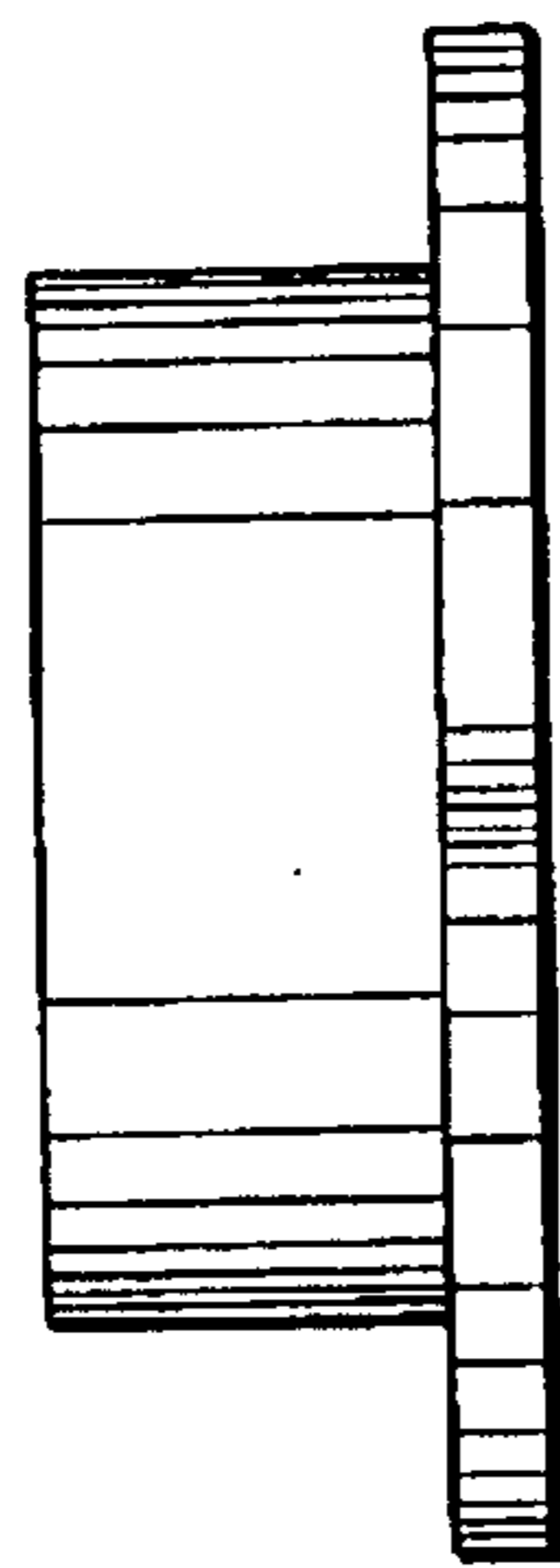
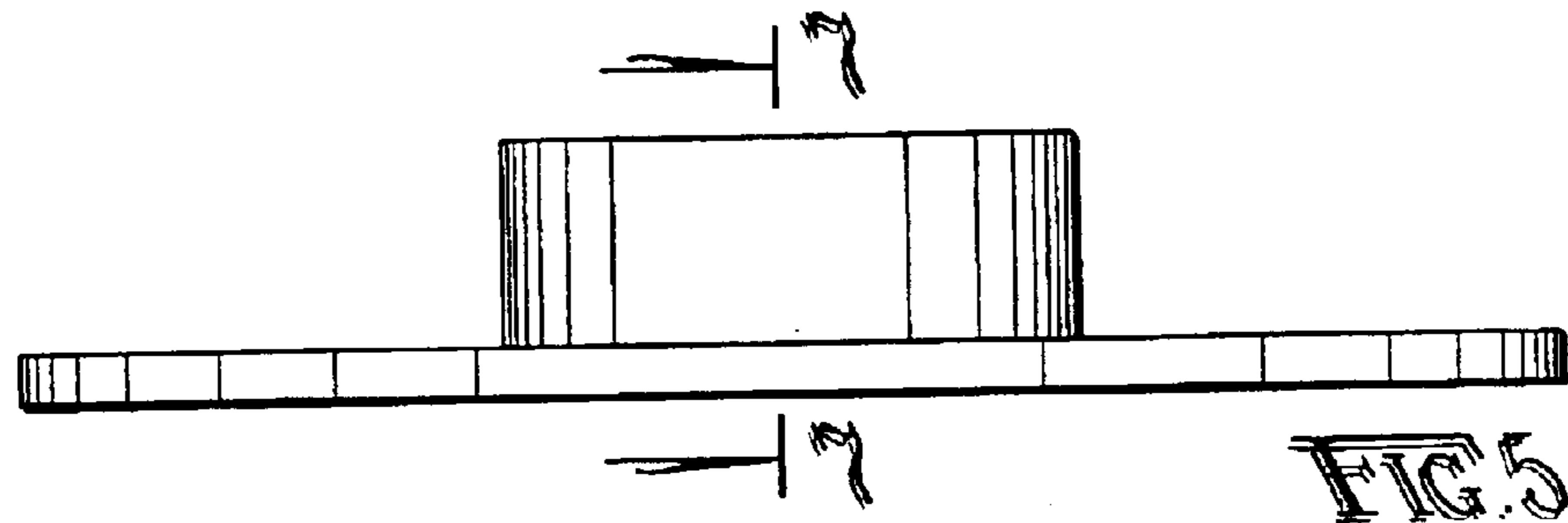
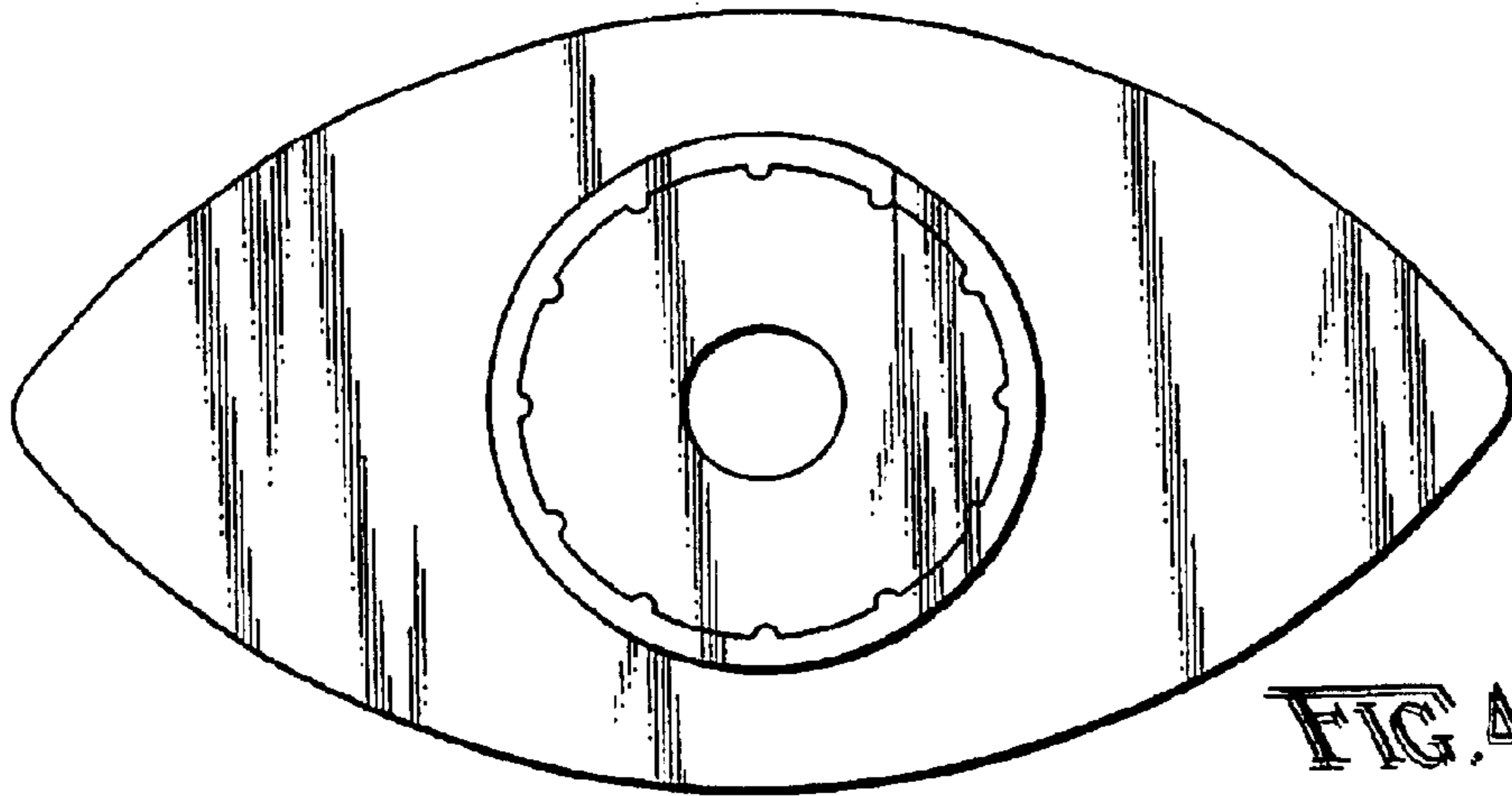

FIG. 3



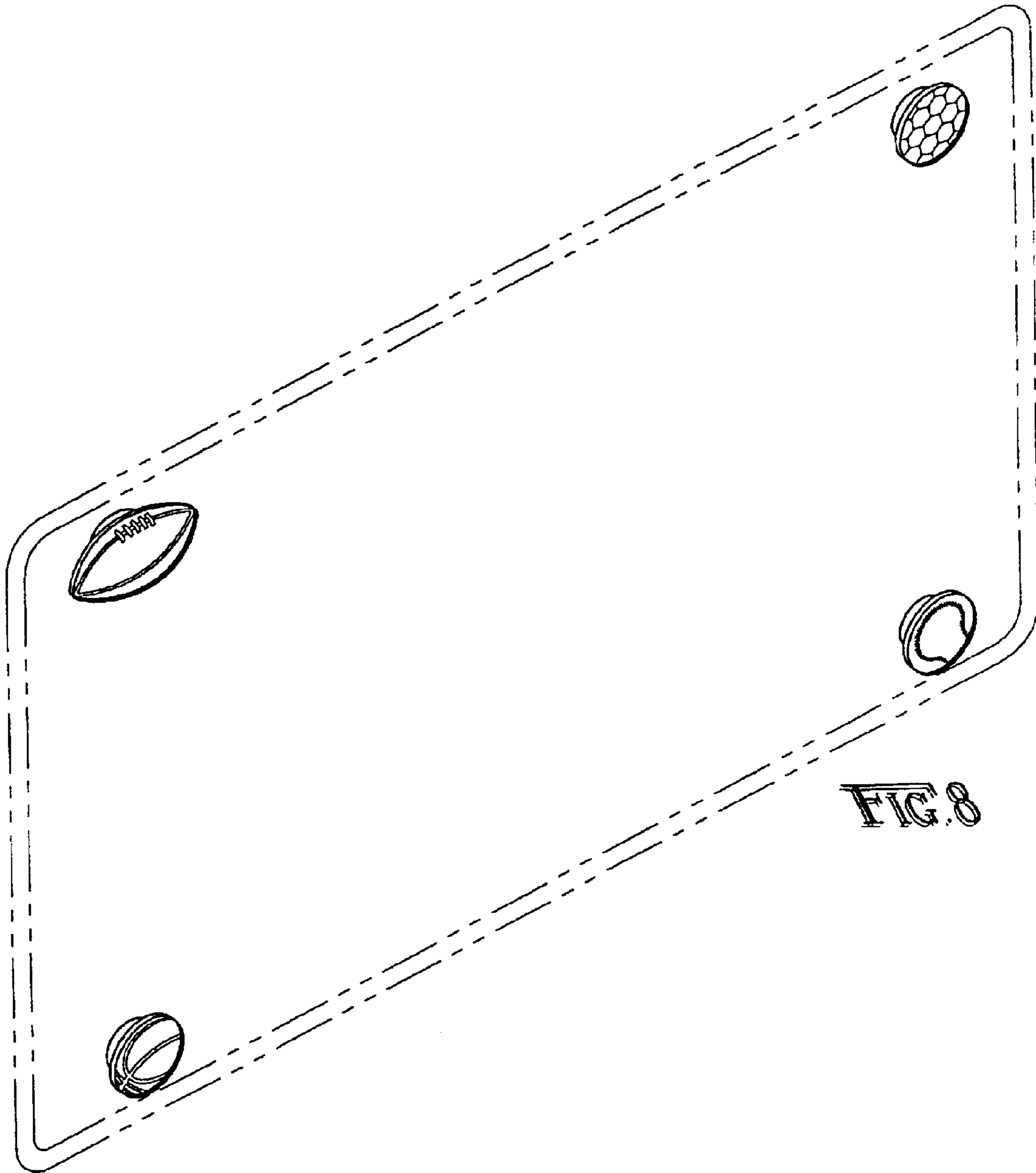

FIG. 8

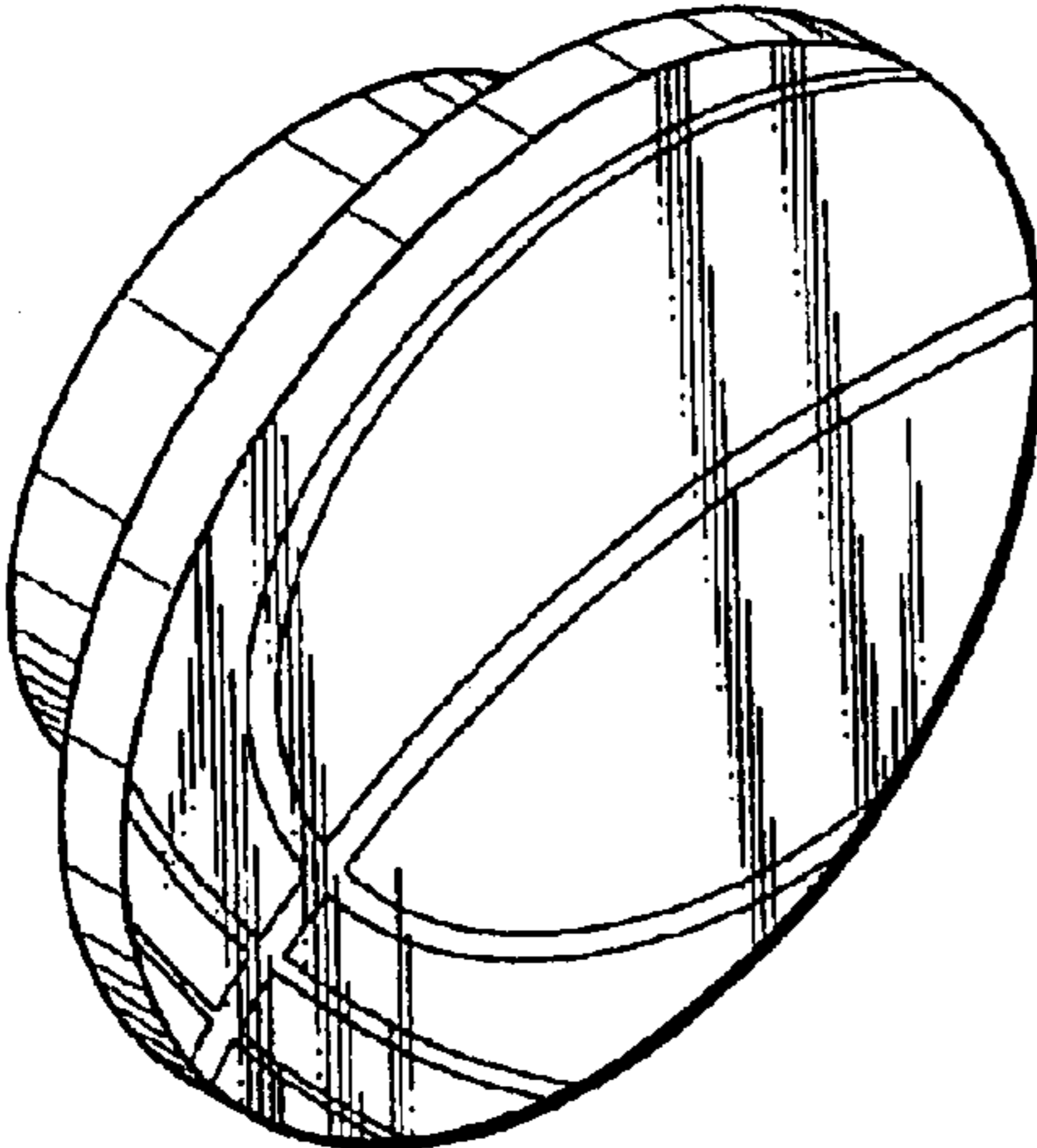

FIG. 9

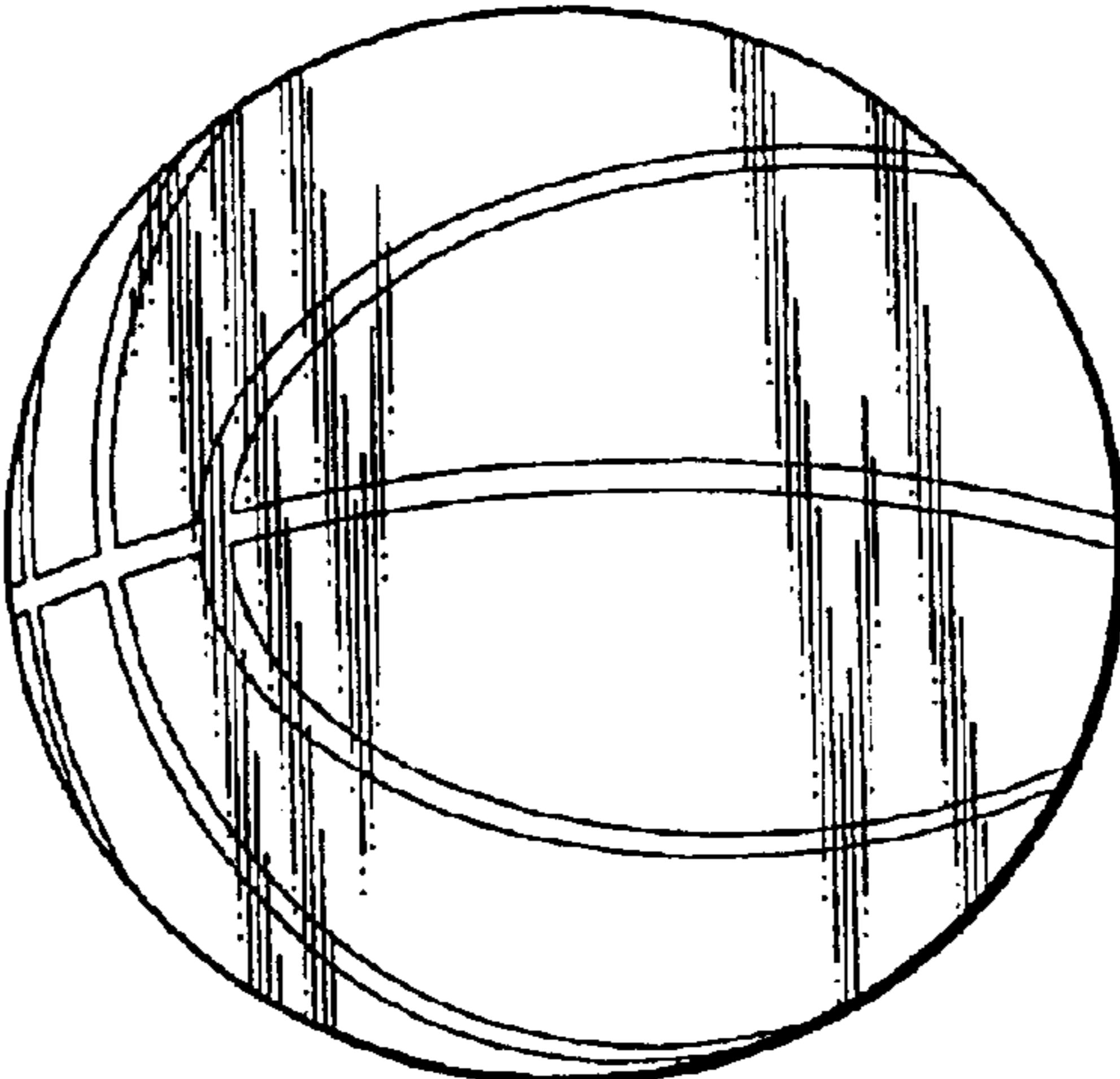

FIG. 10

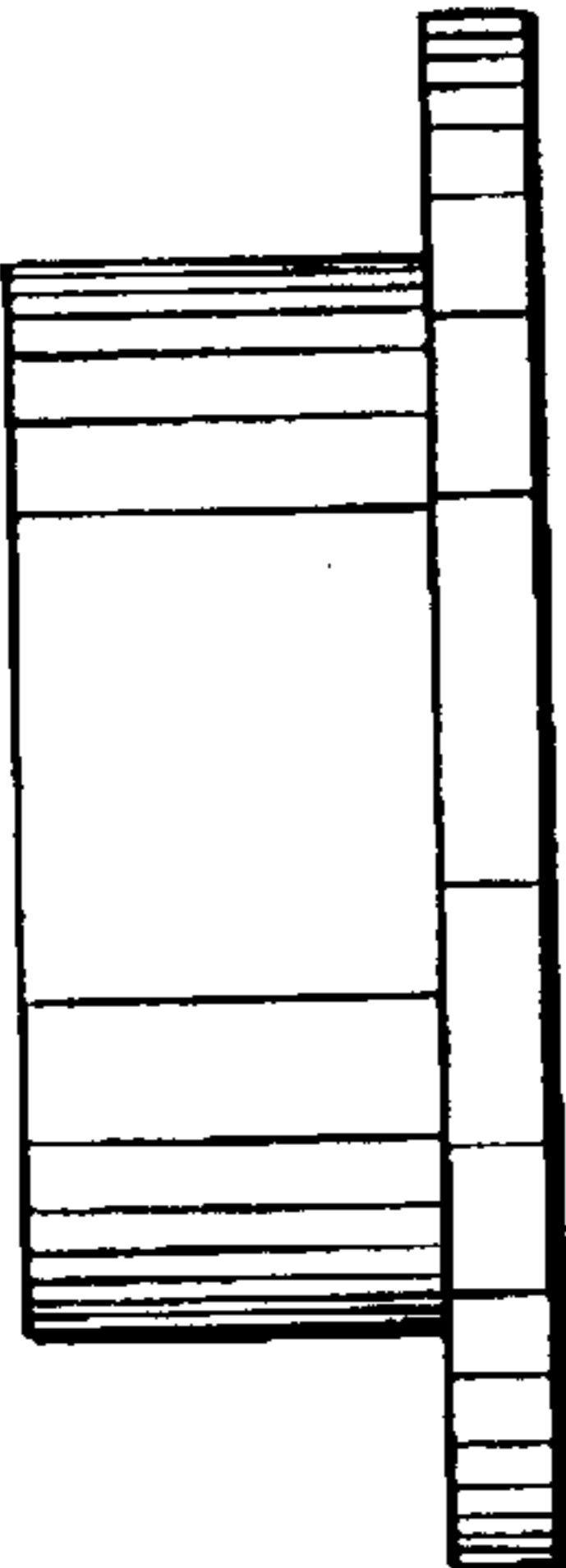

FIG. 11

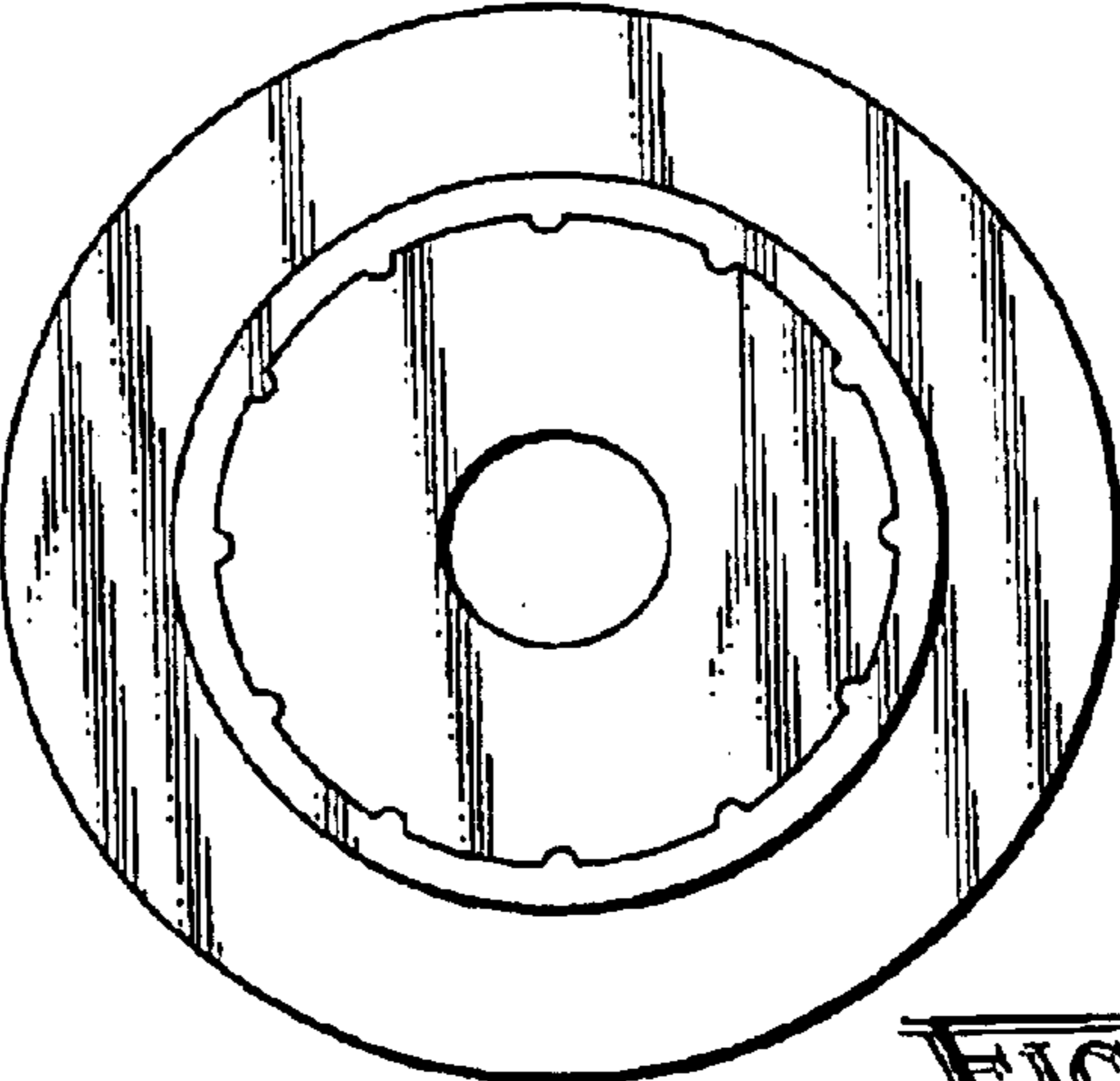

FIG. 12

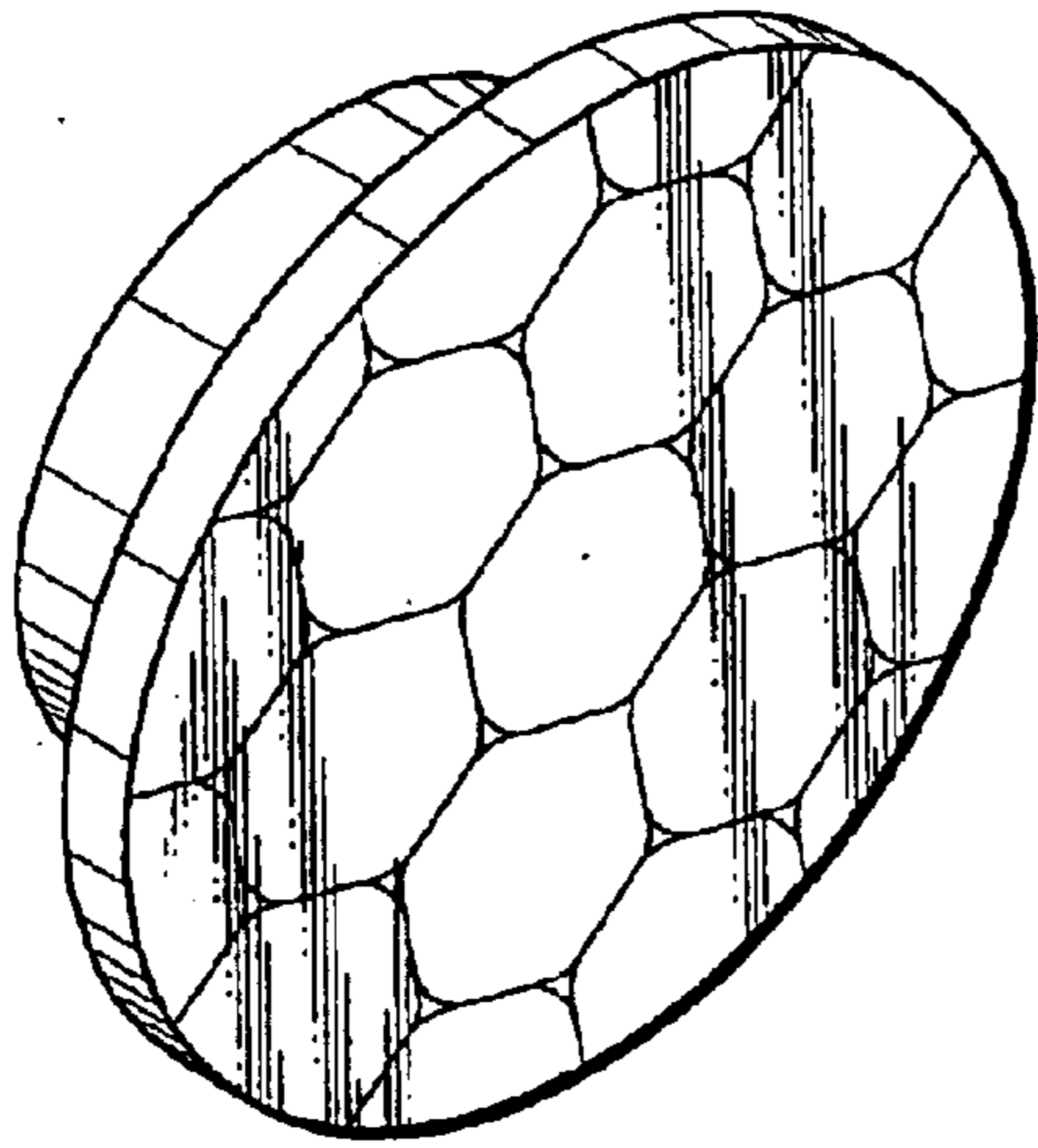

FIG. 13

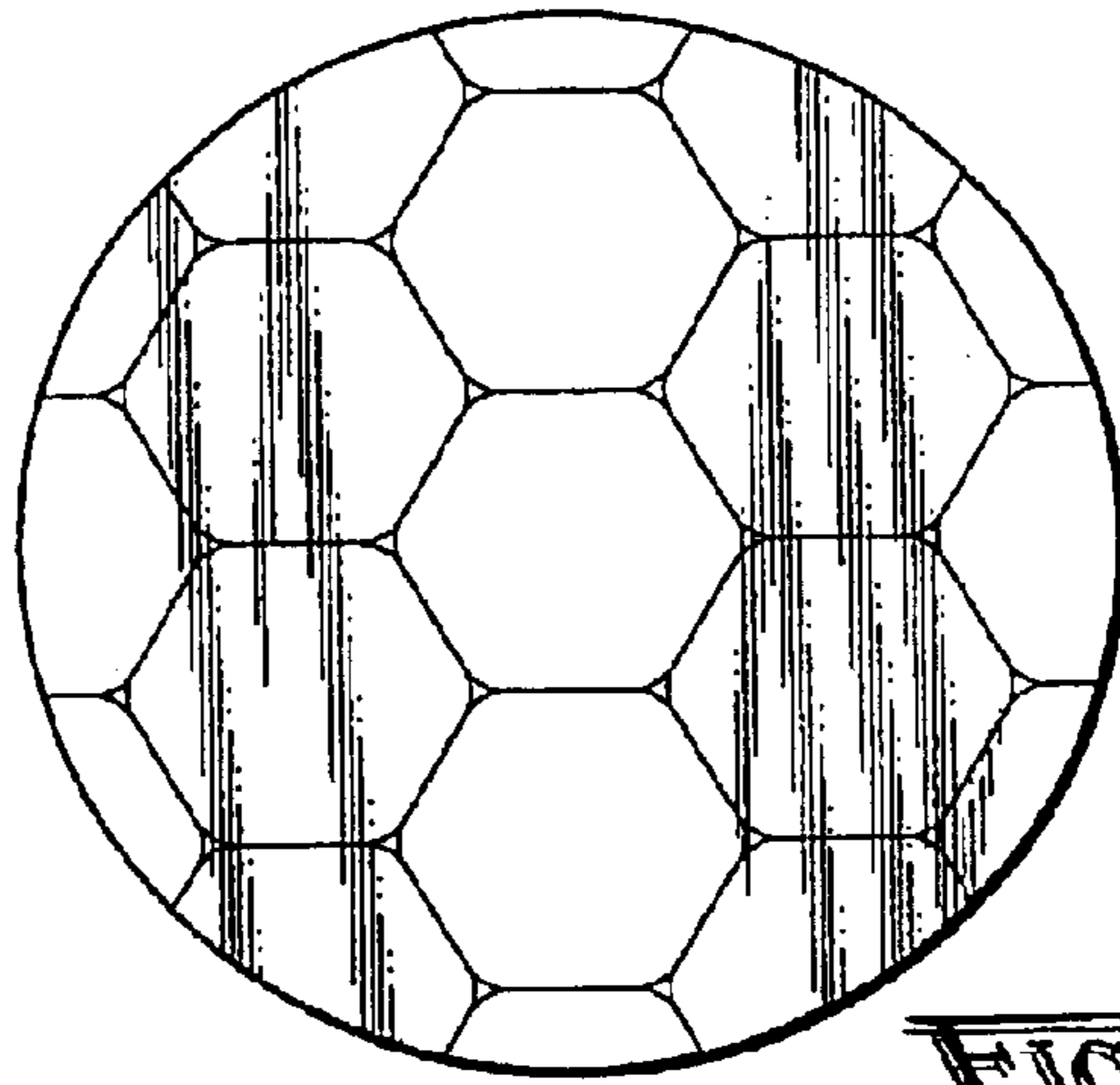

FIG. 14

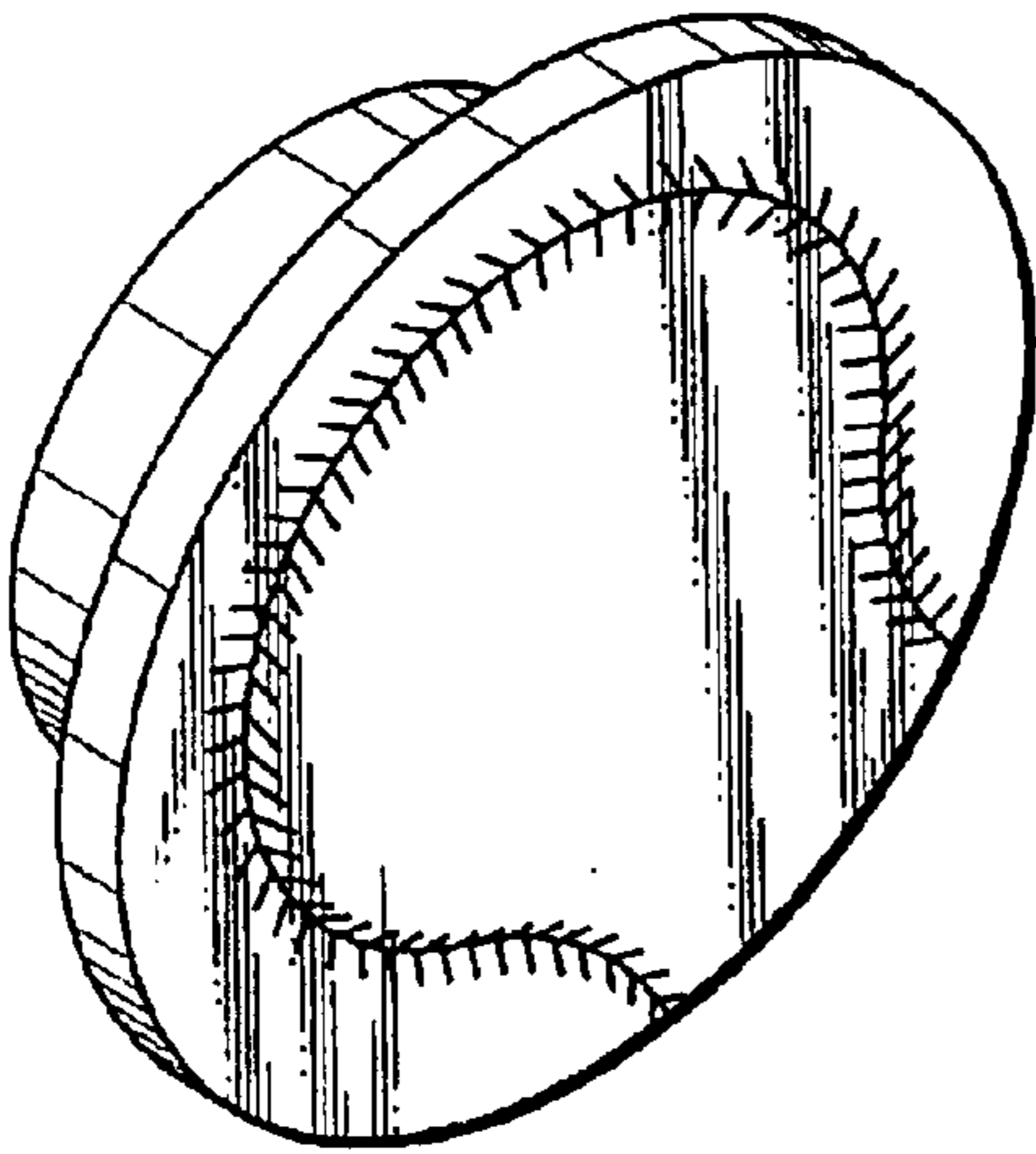

FIG. 15

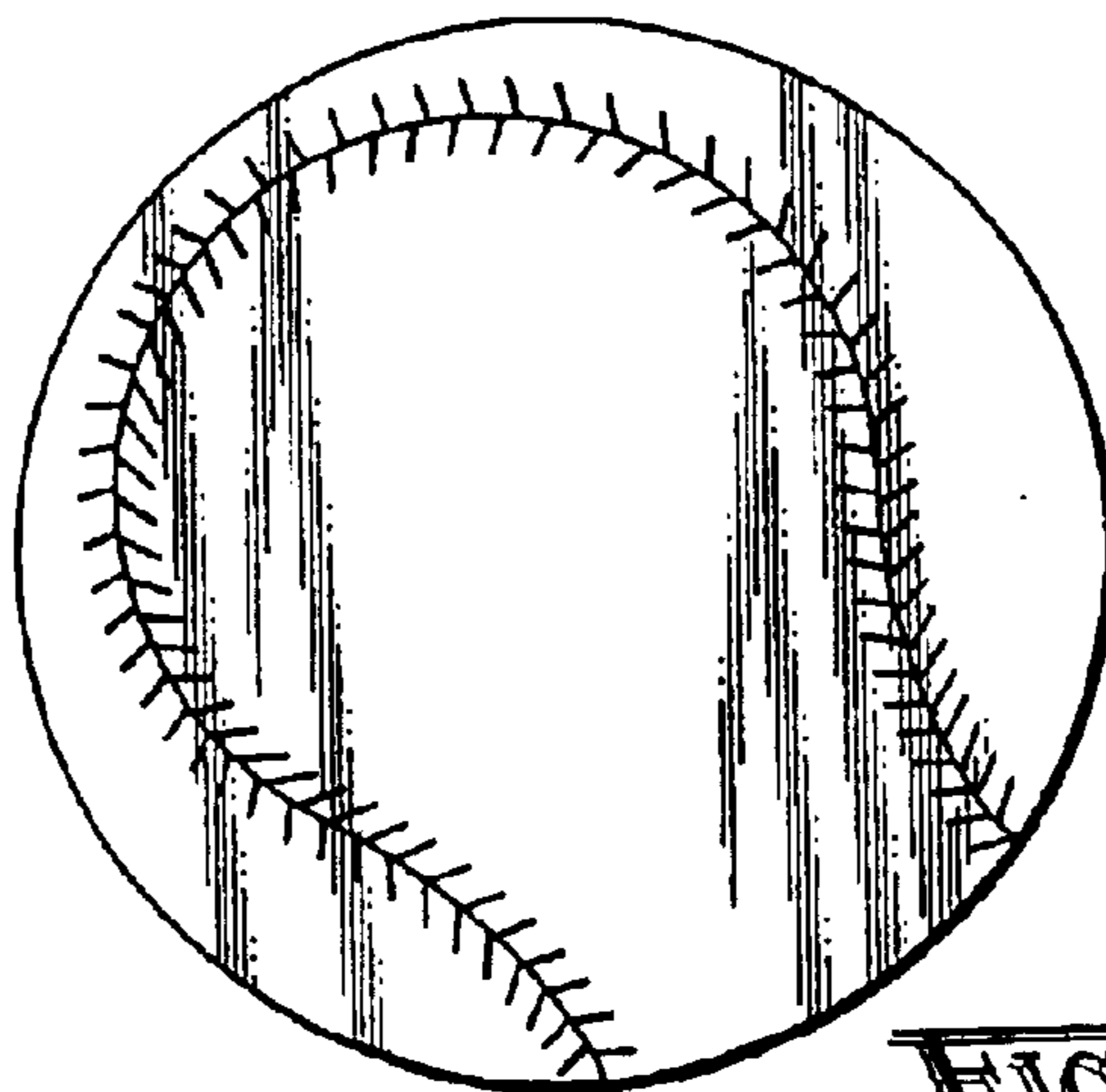

FIG. 16