

US00D492609S1

(12) **United States Design Patent**
Sato

(10) **Patent No.:** **US D492,609 S**
(45) **Date of Patent:** **** Jul. 6, 2004**

(54) **ELECTRONIC SCALE**

(75) Inventor: **Masaaki Sato**, Shiki (JP)

(73) Assignee: **Tanita Corporation**, Tokyo (JP)

(**) Term: **14 Years**

(21) Appl. No.: **29/185,589**

(22) Filed: **Jul. 1, 2003**

(30) **Foreign Application Priority Data**

Jan. 9, 2003 (JP) 2003-000306

(51) **LOC (7) Cl.** **10-04**

(52) **U.S. Cl.** **D10/91**

(58) **Field of Search** D10/87-93, 83;
600/547, 506; 324/692; 177/238-245, 177,
199, 210 R, 126, 25.12-25.18, DIG. 3,
4

(56) **References Cited**

U.S. PATENT DOCUMENTS

D455,092 S * 4/2002 Kesselman D10/91
D478,826 S * 8/2003 Barmes D10/91

* cited by examiner

Primary Examiner—Lucy Lieberman

(74) *Attorney, Agent, or Firm*—McDermott, Will & Emery

(57) **CLAIM**

The ornamental design for an electronic scale, as shown and described.

DESCRIPTION

FIG. 1 is a perspective view of an electronic scale according

to my novel design;

FIG. 2 is a front view of the electronic scale of FIG. 1;

FIG. 3 is a rear view of the electronic scale of FIG. 1;

FIG. 4 is a right side view of the electronic scale of FIG. 1;

FIG. 5 is a left side view of the electronic scale of FIG. 1;

FIG. 6 is a plan view of the electronic scale of FIG. 1;

FIG. 7 is a bottom view of the electronic scale of FIG. 1;

FIG. 8 is a perspective view of the electronic scale of FIG. 1 with the cover being open;

FIG. 9 is a front view of the electronic scale of FIG. 1 with the cover being open;

FIG. 10 is a rear view of the electronic scale of FIG. 1 with the cover being open;

FIG. 11 is a right side view of the electronic scale of FIG. 1 with the cover being open;

FIG. 12 is a left side view of the electronic scale of FIG. 1 with the cover being open;

FIG. 13 is a plan view of the electronic scale of FIG. 1 with the cover being open;

FIG. 14 is a bottom view of the electronic scale of FIG. 1 with the cover being open; and,

FIG. 15 is a plan view of the electronic scale of FIG. 1 with the cover being open and the display being switched on.

1 Claim, 5 Drawing Sheets

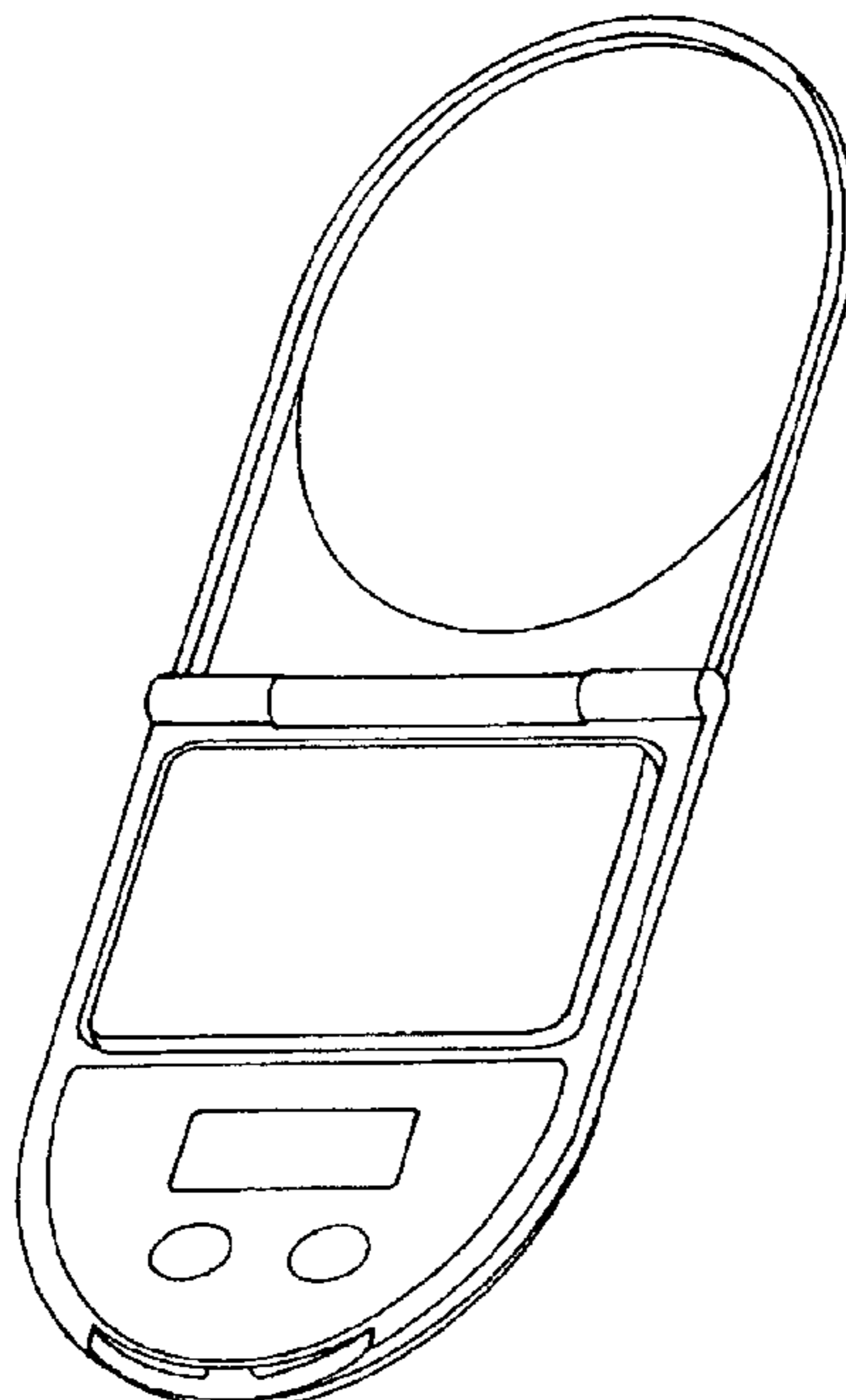

FIG. 1

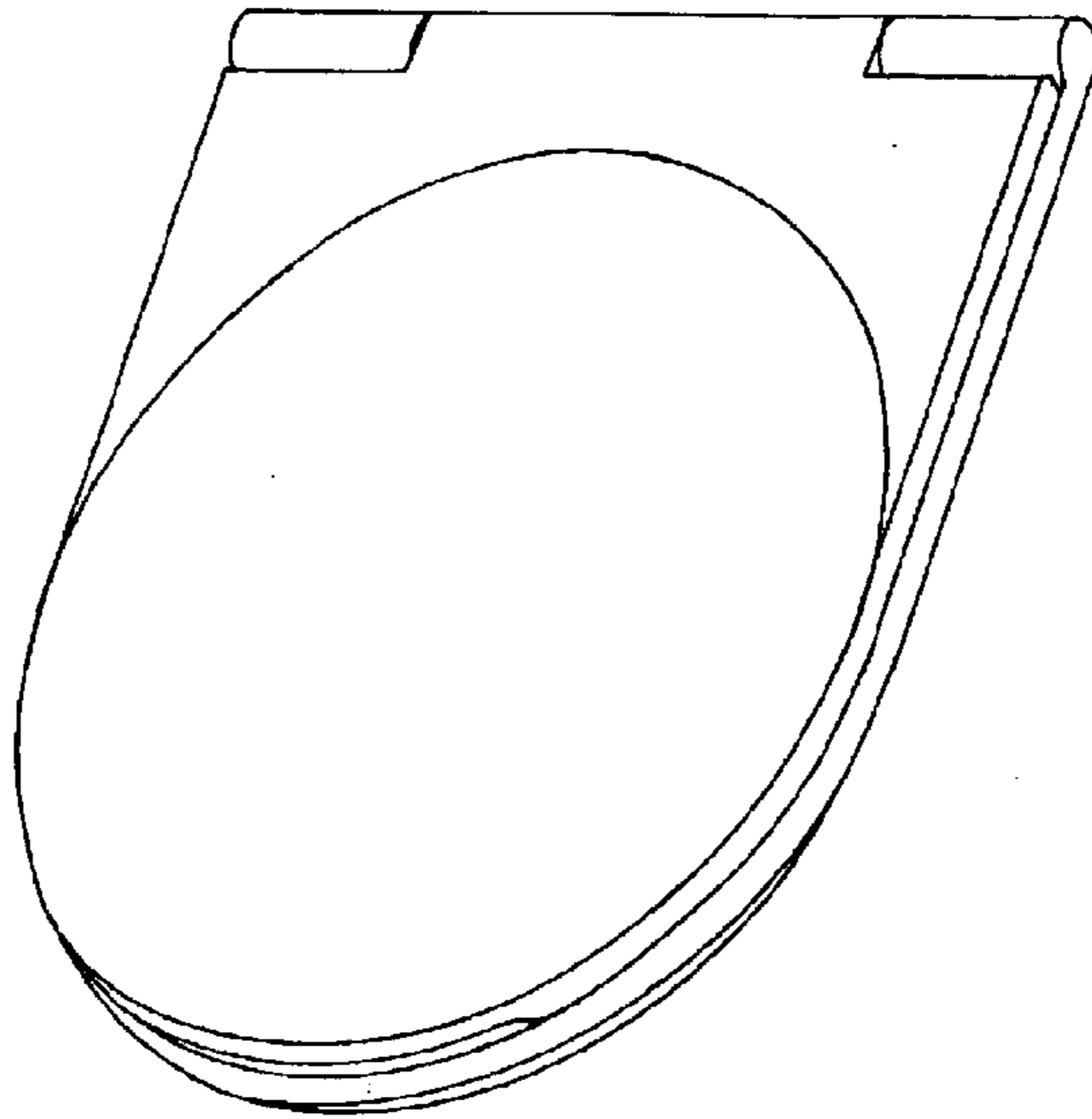

FIG. 2

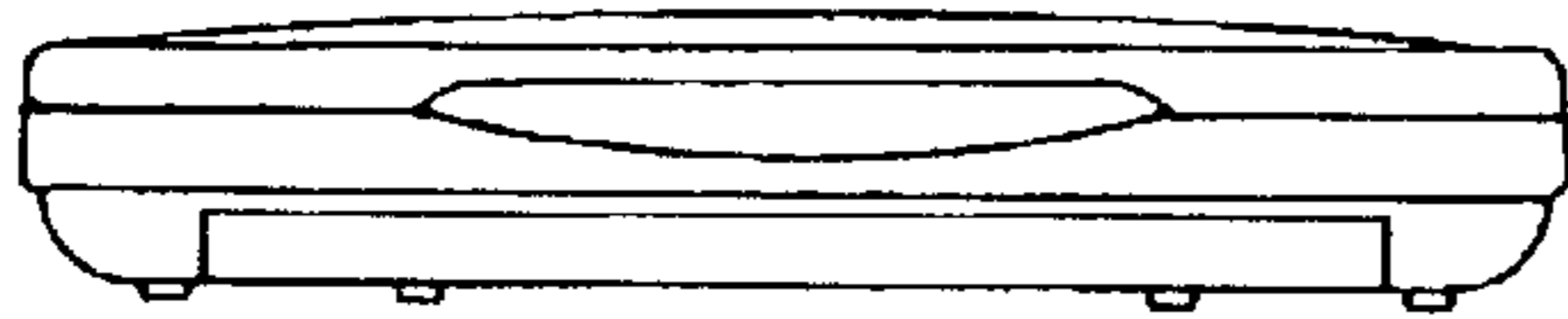

FIG. 3

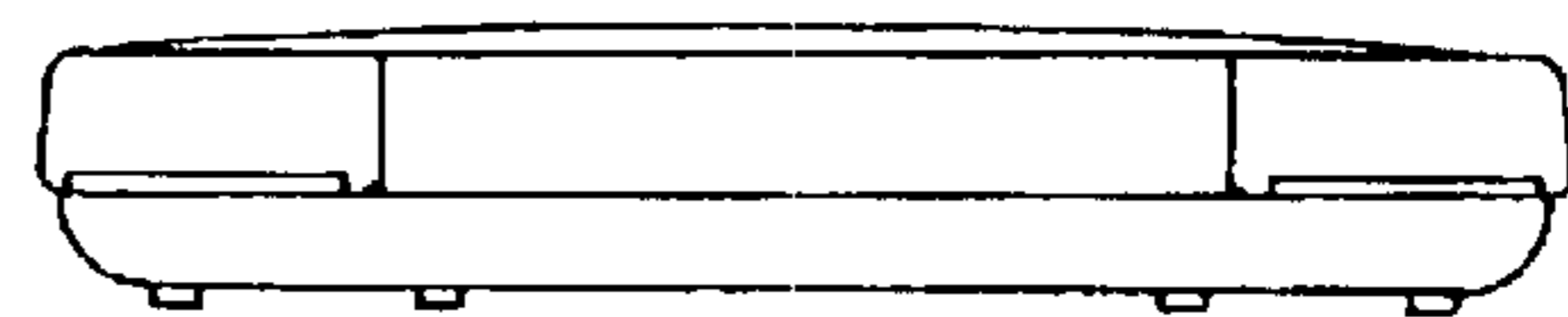

FIG. 4

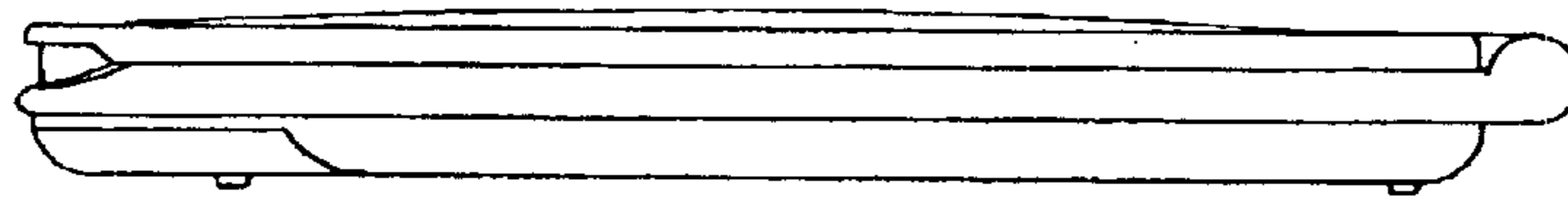

FIG. 5

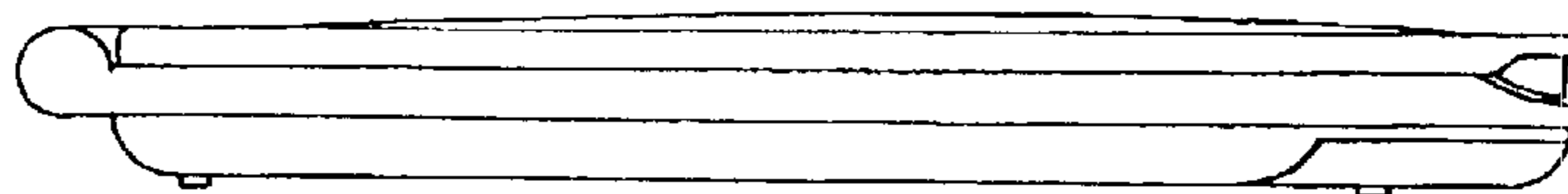

FIG. 6

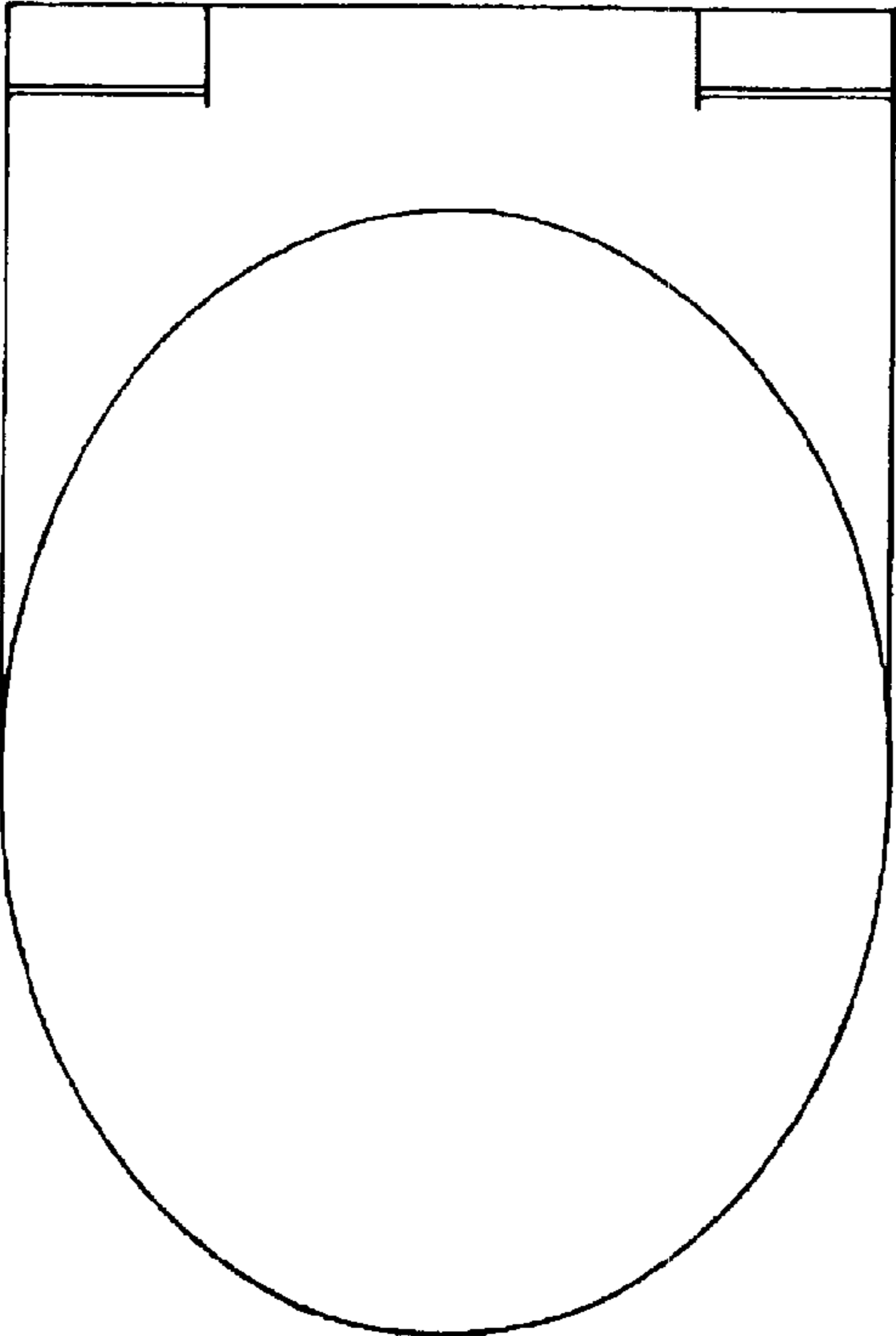

FIG. 7

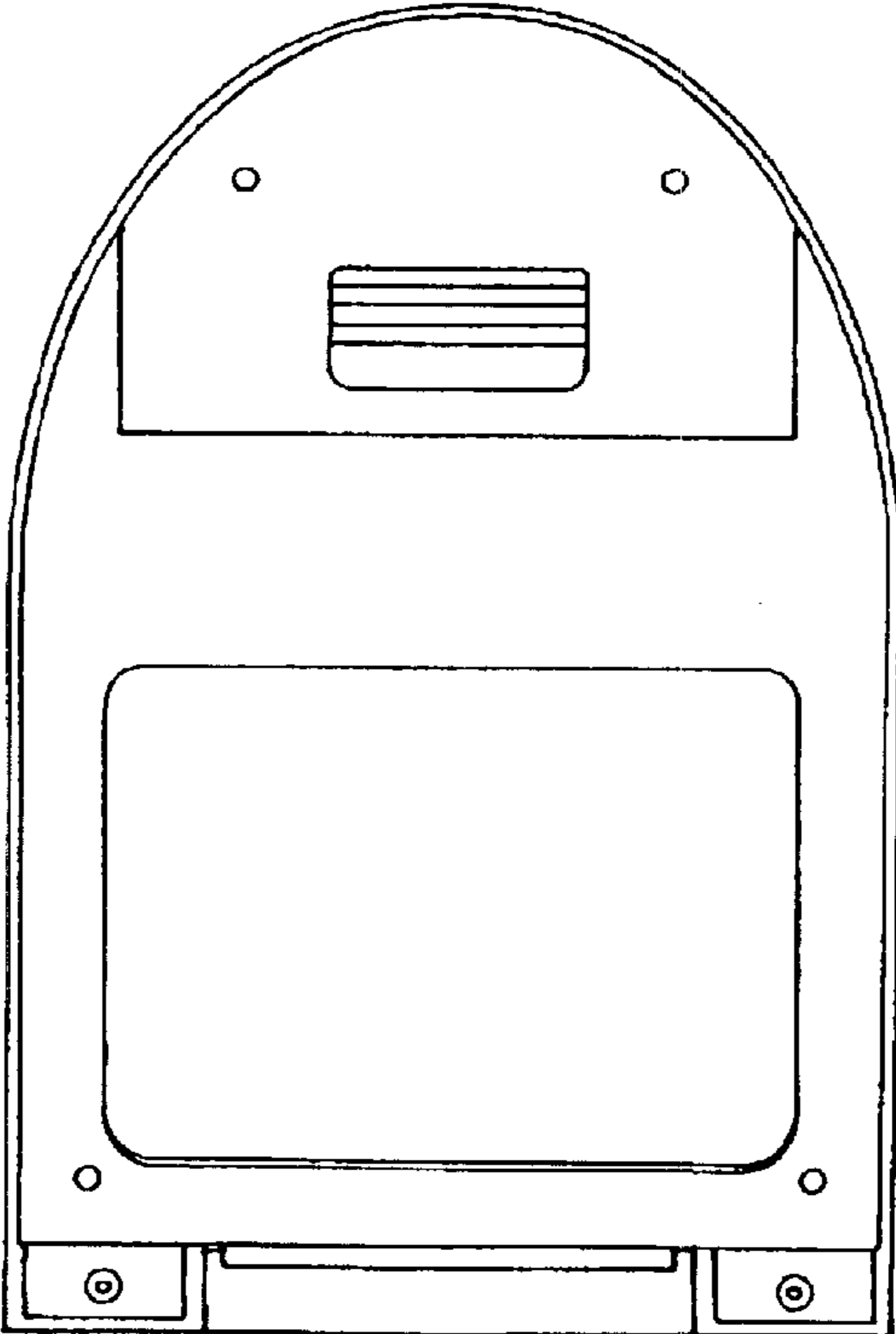

FIG. 8

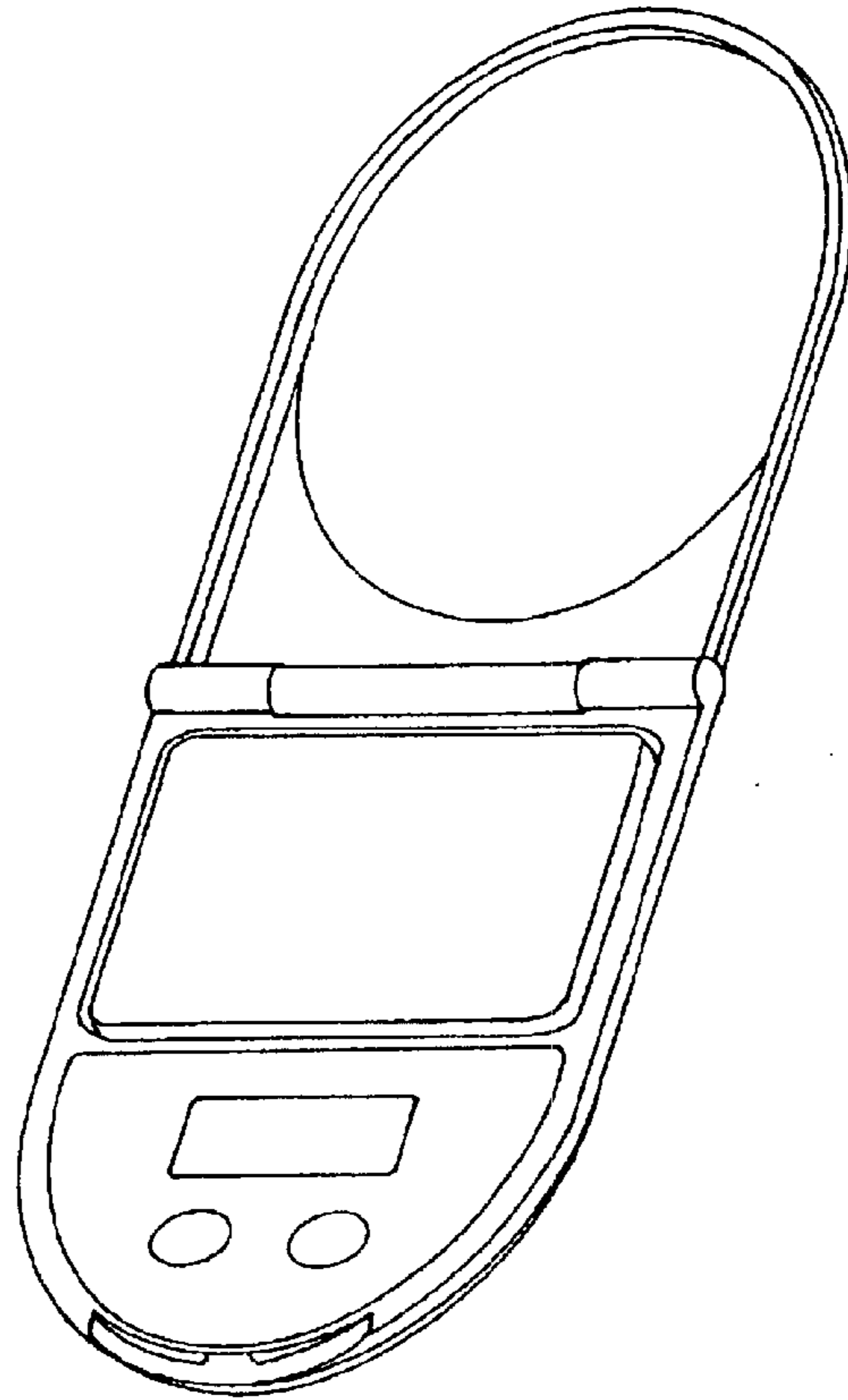

FIG. 9

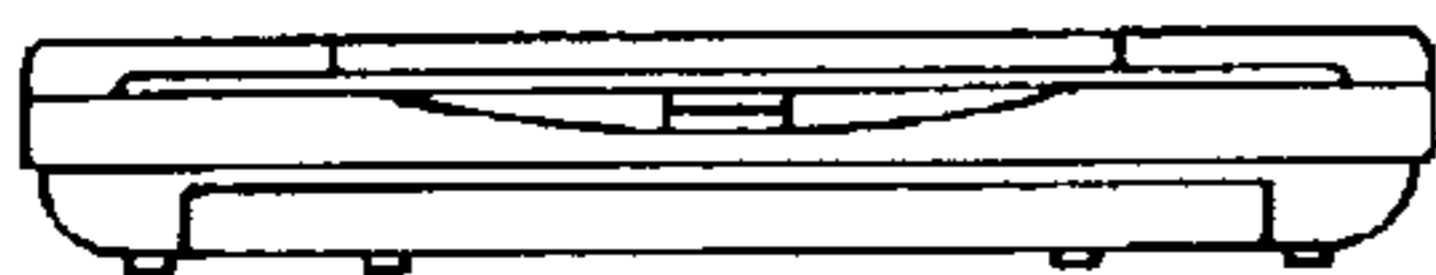

FIG. 10

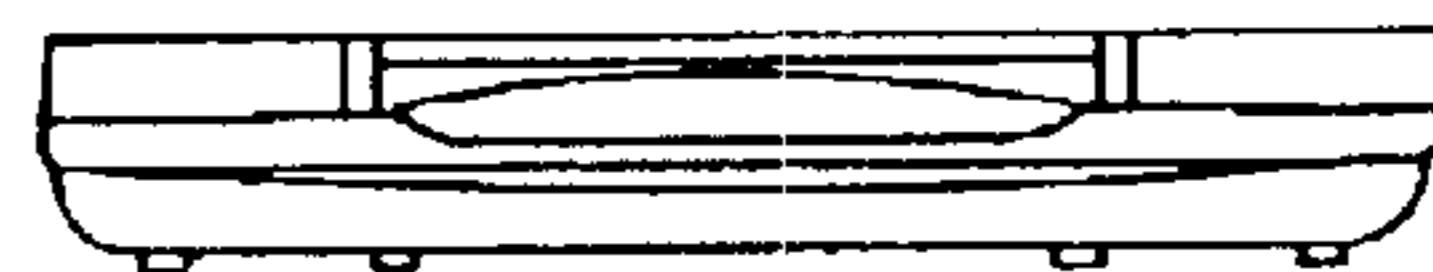

FIG. 11

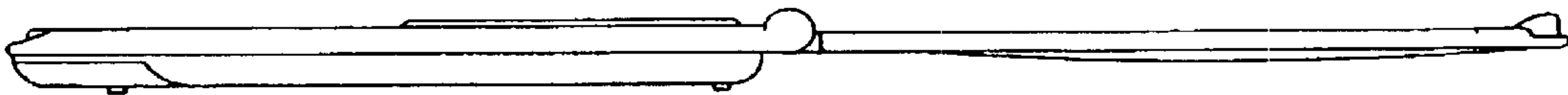

FIG. 12



FIG. 13

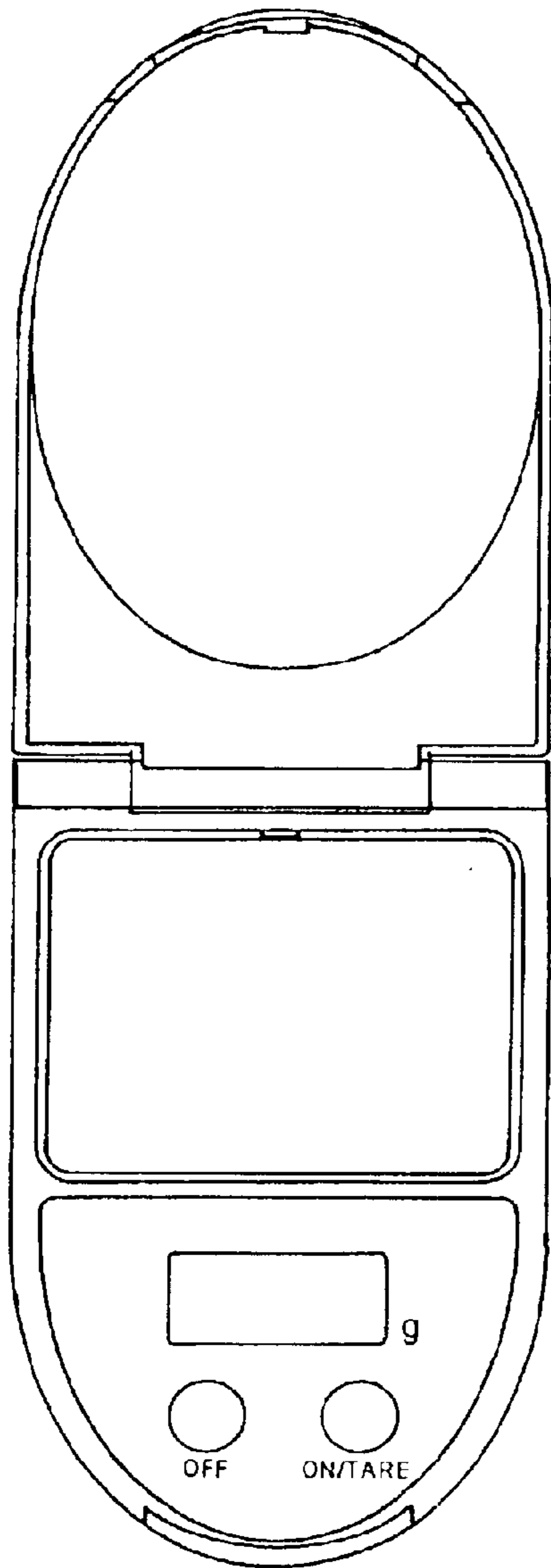

FIG. 14

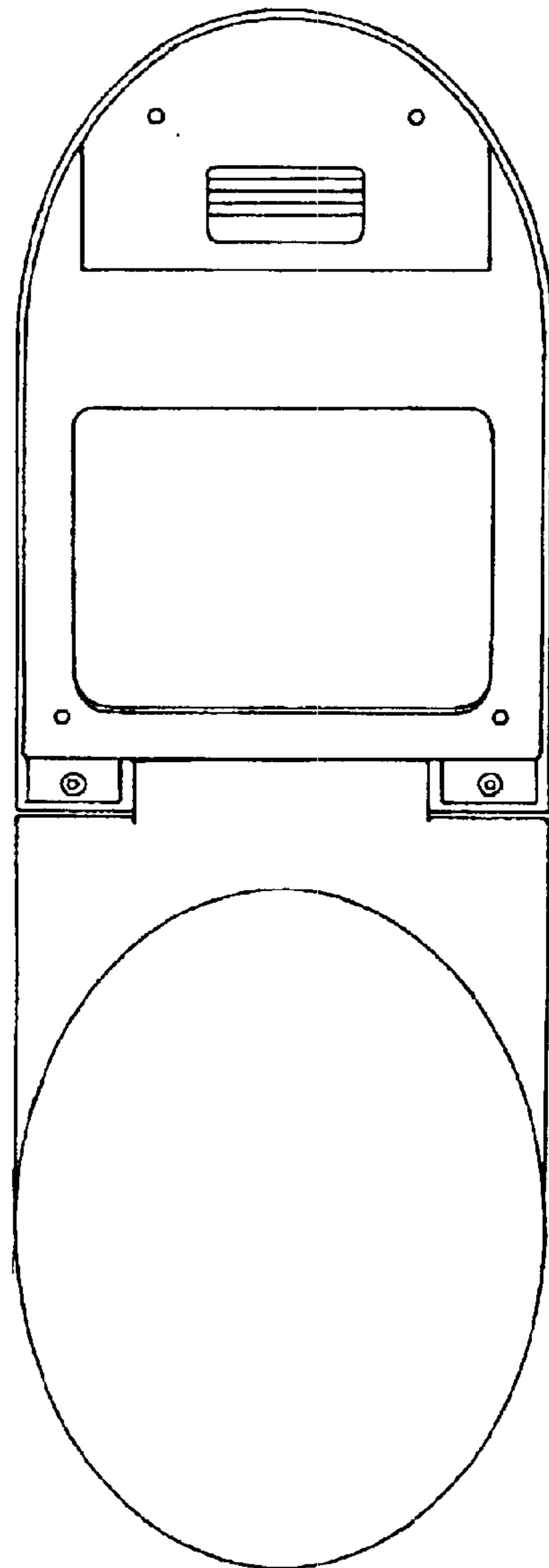

FIG. 15

