

US00D492597S1

(12) **United States Design Patent**
Norris et al.

(10) **Patent No.: US D492,597 S**
(45) **Date of Patent: ** Jul. 6, 2004**

(54) **CLOSURE**

(75) Inventors: **Joseph T. Norris**, West Windsor, NJ (US); **John C. Crawford**, Mahopac, NY (US); **Scott Murray Walsh**, Flanders, NJ (US)

(73) Assignee: **Colgate-Palmolive Company**, New York, NY (US)

(**) Term: **14 Years**

(21) Appl. No.: **29/183,859**

(22) Filed: **Jun. 18, 2003**

(51) **LOC (7) Cl.** **09-07**

(52) **U.S. Cl.** **D9/442; D9/446; D9/447; D9/449**

(58) **Field of Search** D9/449, 447, 446, D9/442, 435, 460, 302, 503, 529, 450, 453; 205/235-237; 220/244, 254, 334, 336; 222/543, 544, 546, 559, 562

(56) **References Cited**

U.S. PATENT DOCUMENTS

4,949,883 A * 8/1990 Dubach 222/556

5,007,555 A * 4/1991 Beck 215/235
D426,773 S * 6/2000 Warner et al. D9/503
D436,040 S * 1/2001 Warner et al. D9/449
D451,023 S * 11/2001 Kitamura et al. D9/449

* cited by examiner

Primary Examiner—Louis S. Zarfes

Assistant Examiner—Gregory Andoll

(74) *Attorney, Agent, or Firm*—Clifford Wilkins

(57) **CLAIM**

The ornamental design for a closure, as shown and described.

DESCRIPTION

FIG. 1 is a perspective view of the closure of our design; FIG. 2 is a front elevation view thereof; FIG. 3 is a rear elevation view thereof; FIG. 4 is a right side elevation view, the left side being a mirror image thereof; FIG. 5 is a top plan view thereof; and, FIG. 6 is a perspective view of the closure opened.

1 Claim, 3 Drawing Sheets

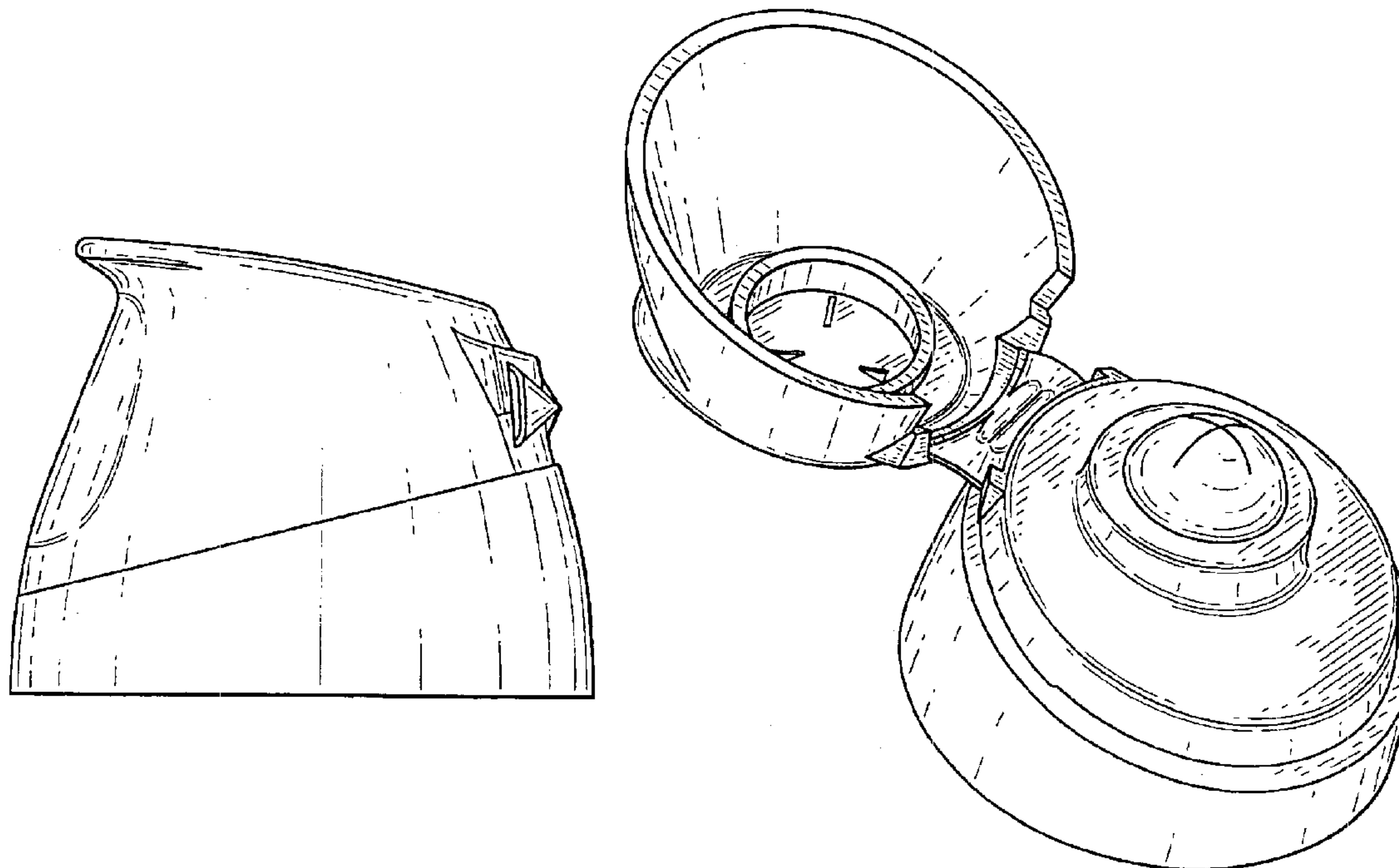

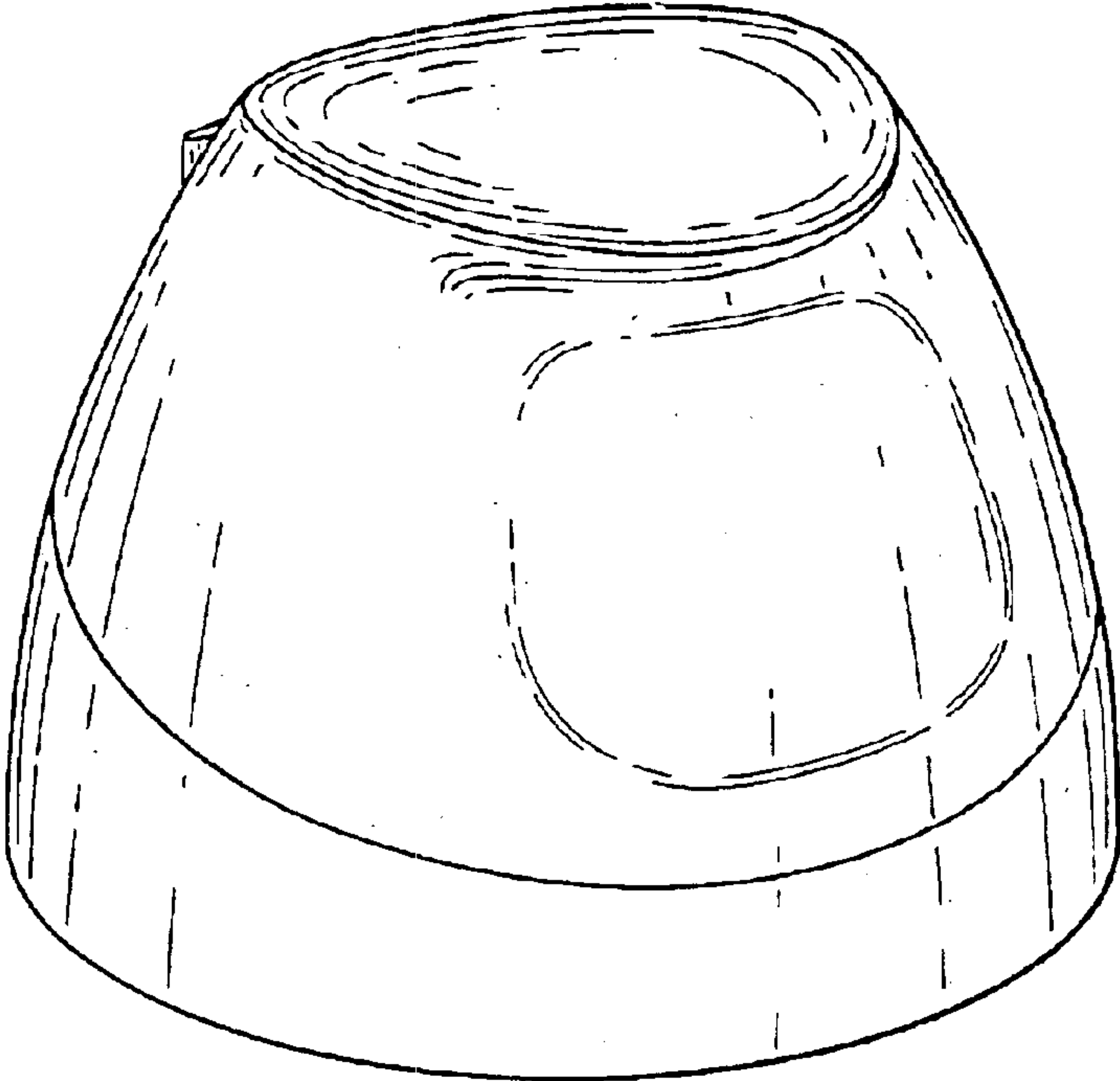

FIG. 1

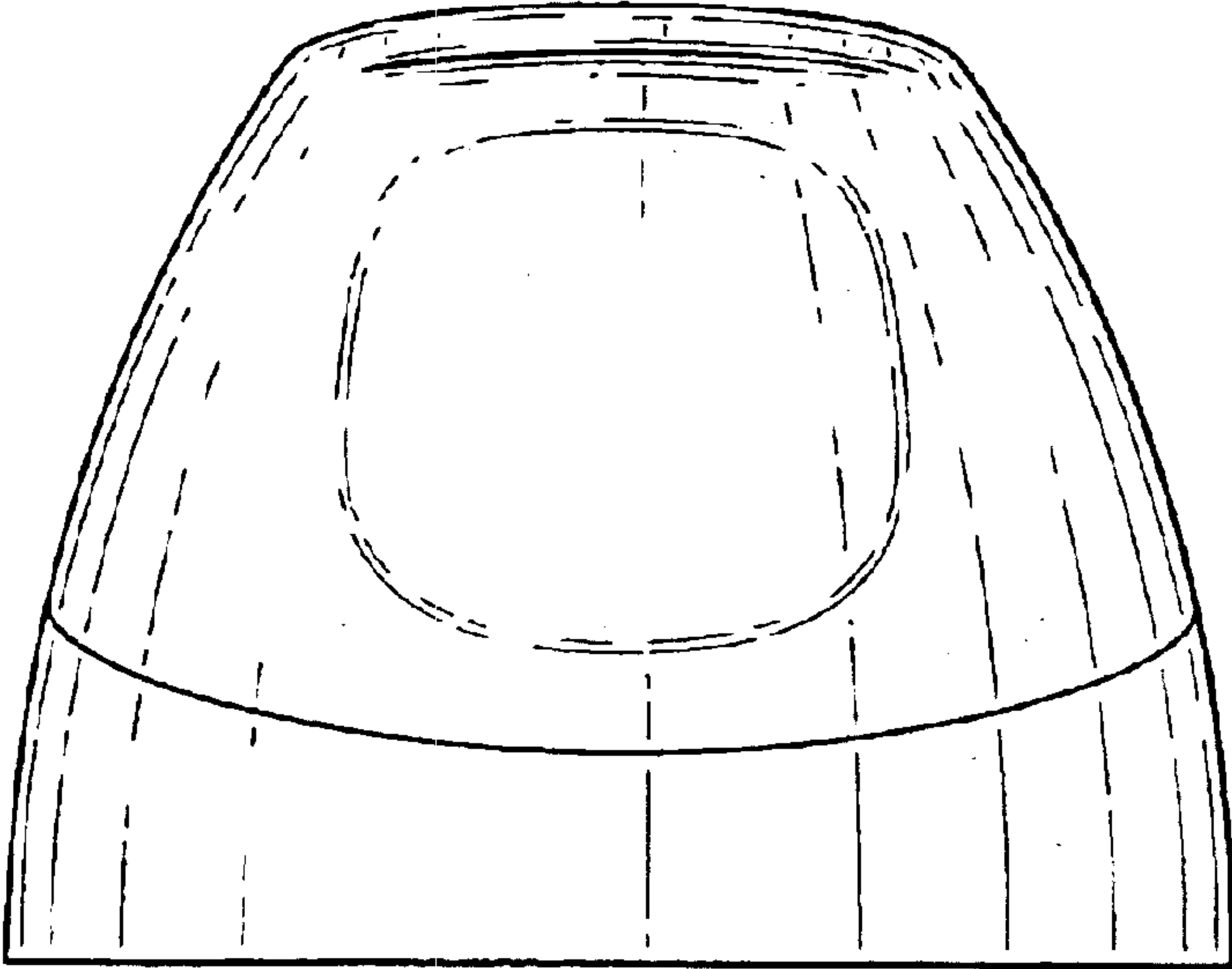

FIG. 2

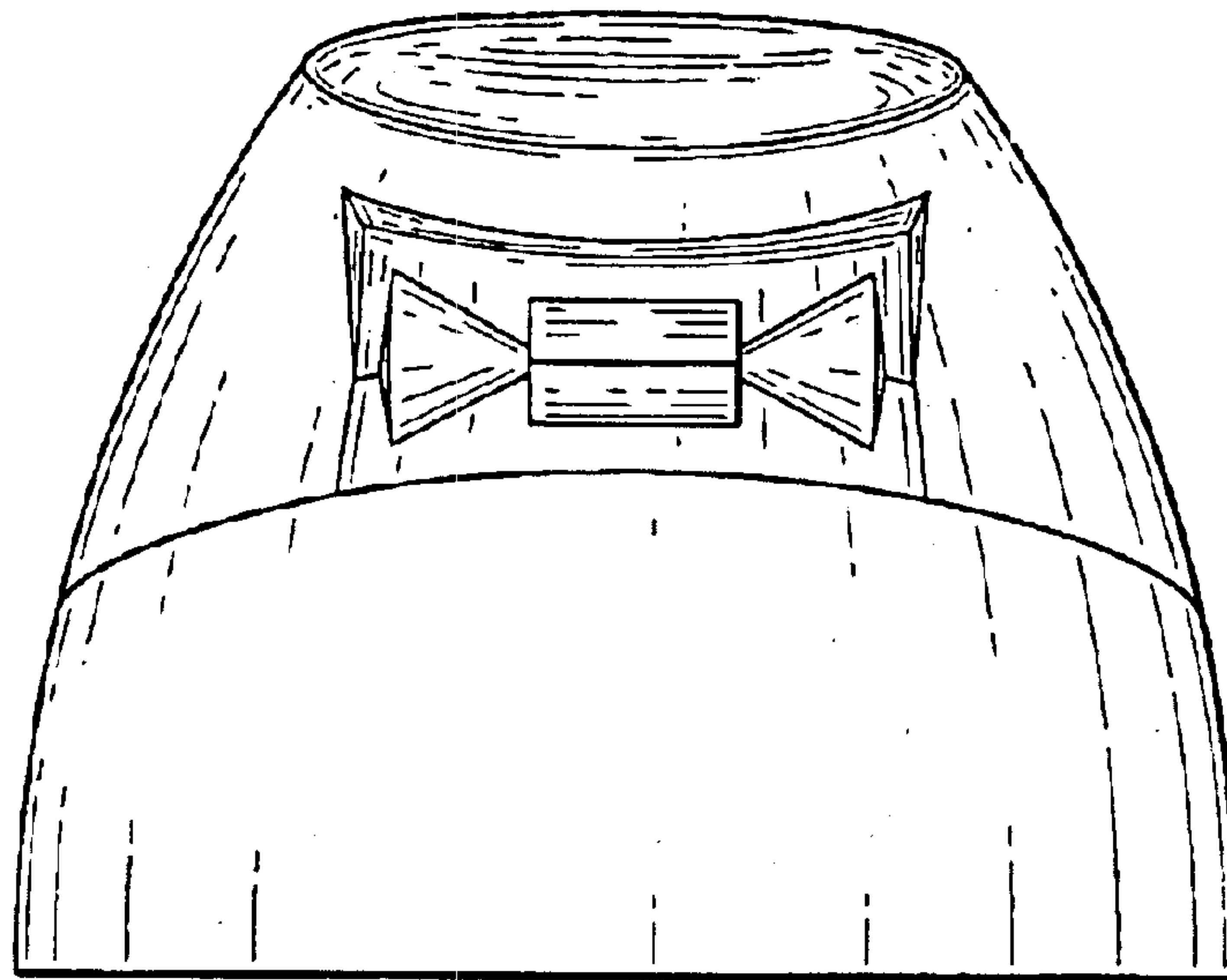

FIG. 3

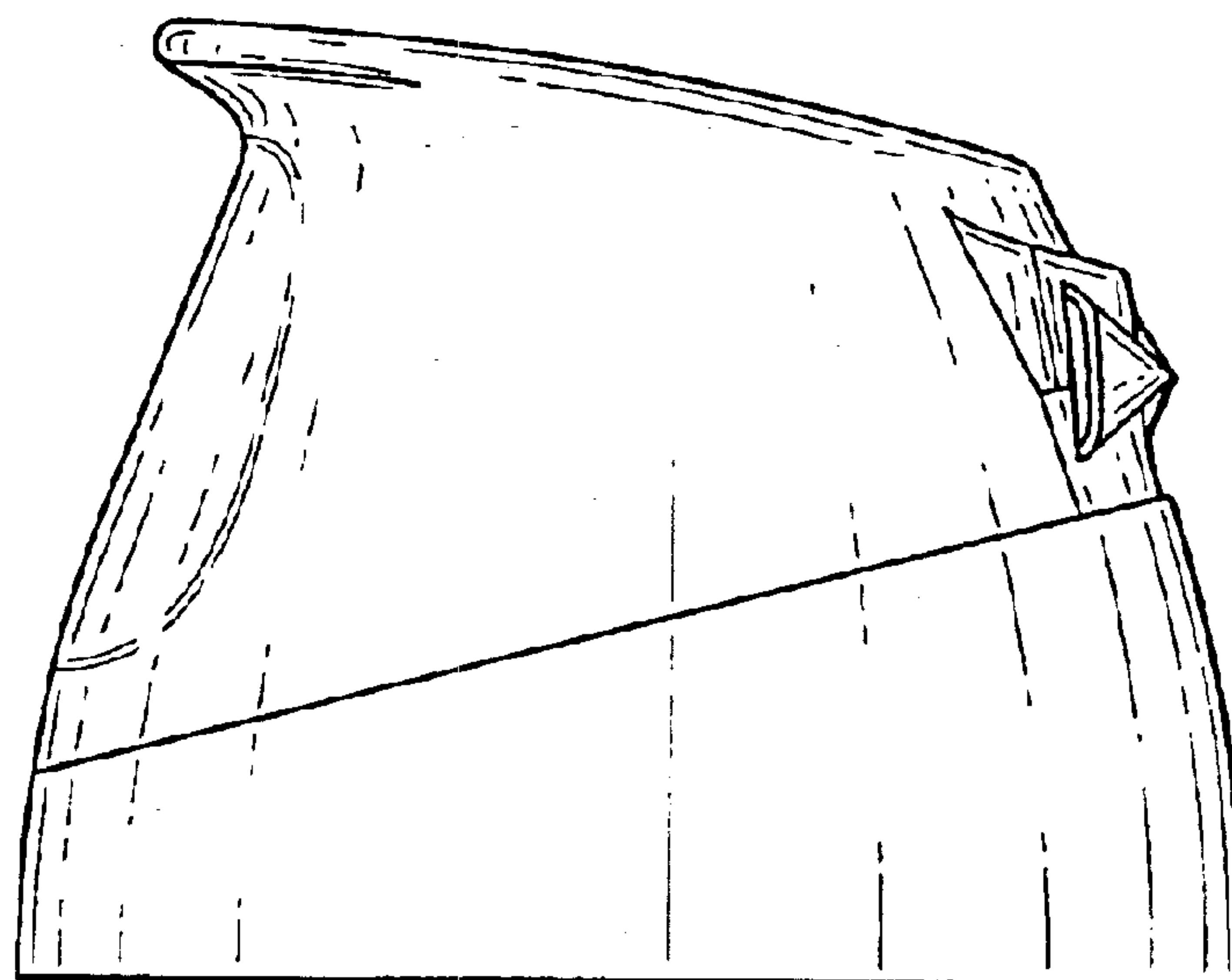

FIG. 4

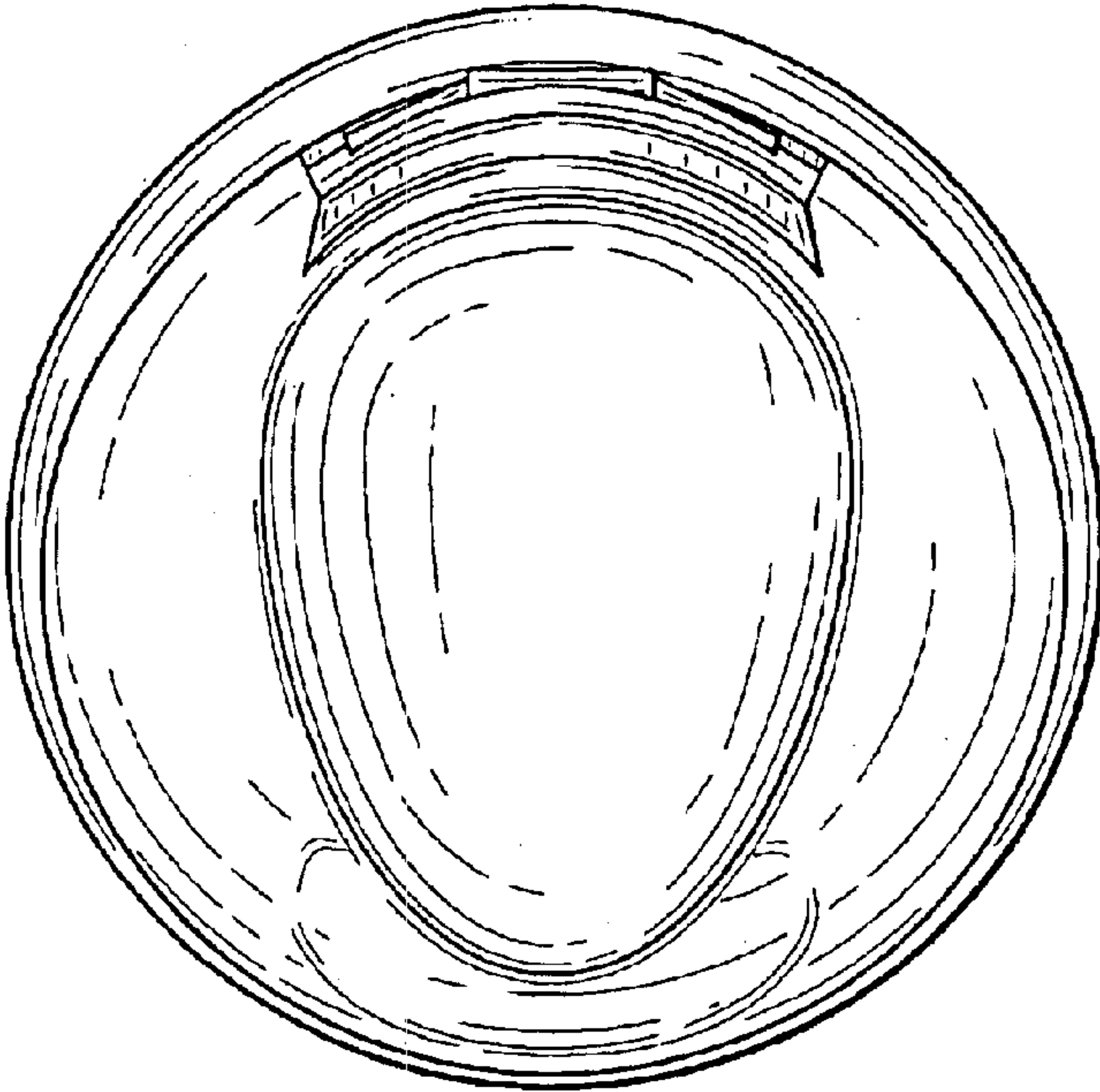

FIG. 5

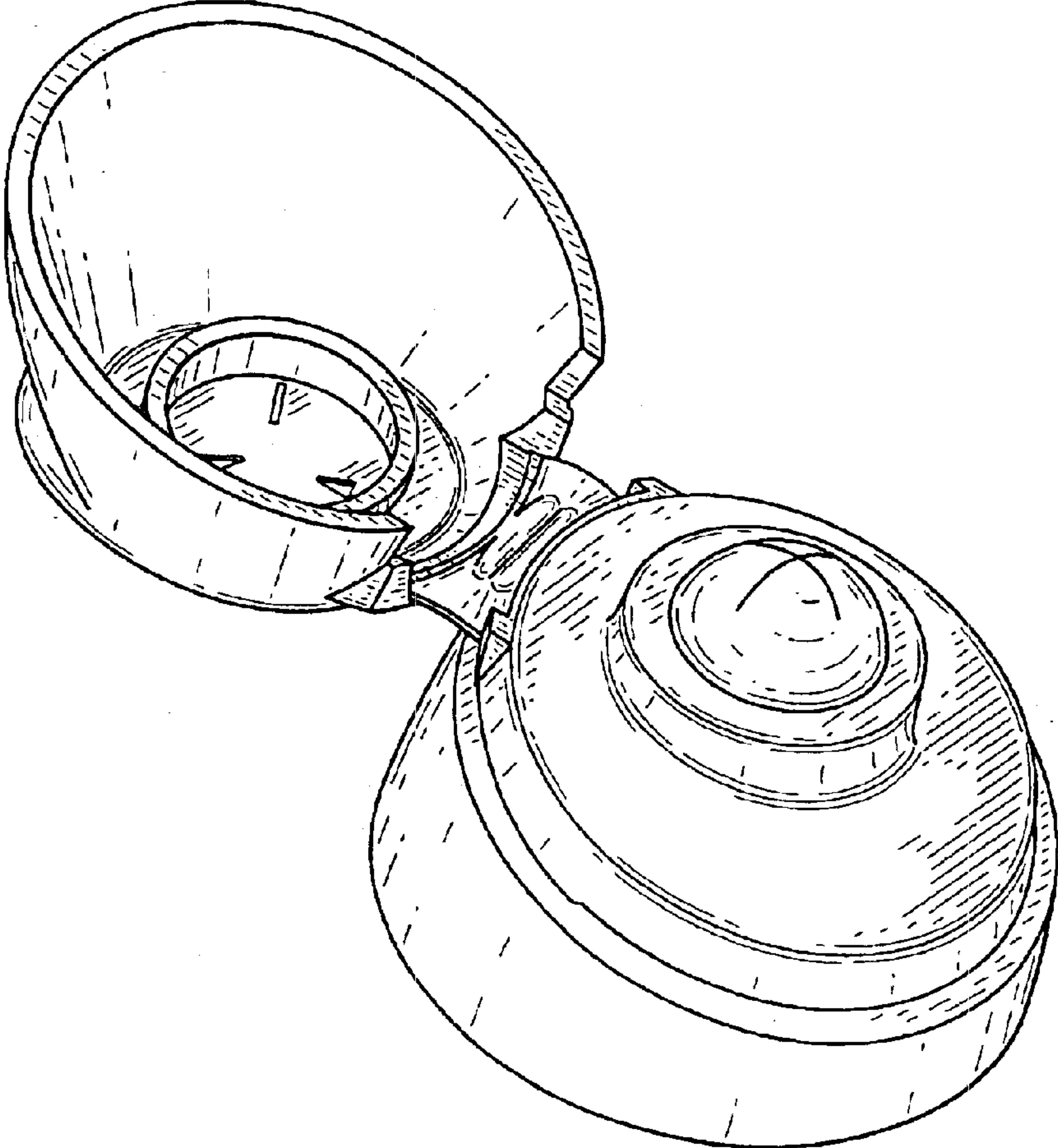

FIG. 6