

US00D492565S1

(12) **United States Design Patent**
Stirm

(10) **Patent No.:** **US D492,565 S**

(45) **Date of Patent:** **** Jul. 6, 2004**

- (54) **COMPACT HAMMER IN-LINE**
- (75) Inventor: **Michael Stirm**, Oberursel (DE)
- (73) Assignee: **Black & Decker Inc.**, Newark, DE (US)
- (**) Term: **14 Years**

D400,415 S	*	11/1998	Zurwelle	D8/68
D406,511 S		3/1999	Zurwelle	D8/68
D406,741 S		3/1999	Zurwelle	D8/68
5,984,020 A	*	11/1999	Meyer et al.	173/217
D442,452 S		5/2001	Stirm	D8/67
D447,677 S		9/2001	Stirm	D8/69
D466,779 S	*	12/2002	Shibata et al.	D8/68
D466,780 S		12/2002	Stirm	D8/69

- (21) Appl. No.: **29/165,652**
- (22) Filed: **Aug. 14, 2002**
- (30) **Foreign Application Priority Data**

Feb. 14, 2002 (GB) 3001472

- (51) **LOC (7) Cl.** **08-02**
- (52) **U.S. Cl.** **D8/68**
- (58) **Field of Search** D8/61, 62, 63, D8/64, 65, 66, 67, 68, 69, 70; 81/57.11, 429, 464, 465, 466, 469, 489; 173/13, 169, 178, 213, 217; 227/8, 114, 120, 130, 136, 142; 310/50; 408/20, 124, 125, 234, 241 R; 451/358

(56) **References Cited**

U.S. PATENT DOCUMENTS

D280,797 S	10/1985	Sakamoto et al.	D8/68
4,630,512 A	*	12/1986	Durr 81/429
D325,860 S	*	5/1992	Fushiya et al. D8/68
D328,411 S		8/1992	Cavedo D8/68
5,159,986 A		11/1992	Hoser	
D342,878 S		1/1994	Watanabe et al. D8/68
D343,105 S		1/1994	Shibata et al. D8/68
D396,621 S	*	8/1998	Zurwelle D8/68

OTHER PUBLICATIONS

Hammer drills, p. 38, DeWalt Tool catalogue, c. 1998.*

* cited by examiner

Primary Examiner—Doris V. Coles

Assistant Examiner—T. Chase Nelson

(74) *Attorney, Agent, or Firm*—Michael P. Leary; Bruce S. Shapiro; Charles E. Yocum

(57) **CLAIM**

The ornamental design for a compact hammer in-line, as shown and described.

DESCRIPTION

FIG. 1 is a front perspective view of a compact hammer in-line showing my new design.

FIG. 2 is a rear perspective view of FIG. 1.

FIG. 3 is a left side elevational view of FIG. 1.

FIG. 4 is a right side elevational view of FIG. 1.

FIG. 5 is a top plan view of FIG. 1.

FIG. 6 is a bottom plan view of FIG. 1.

FIG. 7 is a front elevational view of FIG. 1; and,

FIG. 8 is a rear elevational view of FIG. 1.

1 Claim, 7 Drawing Sheets

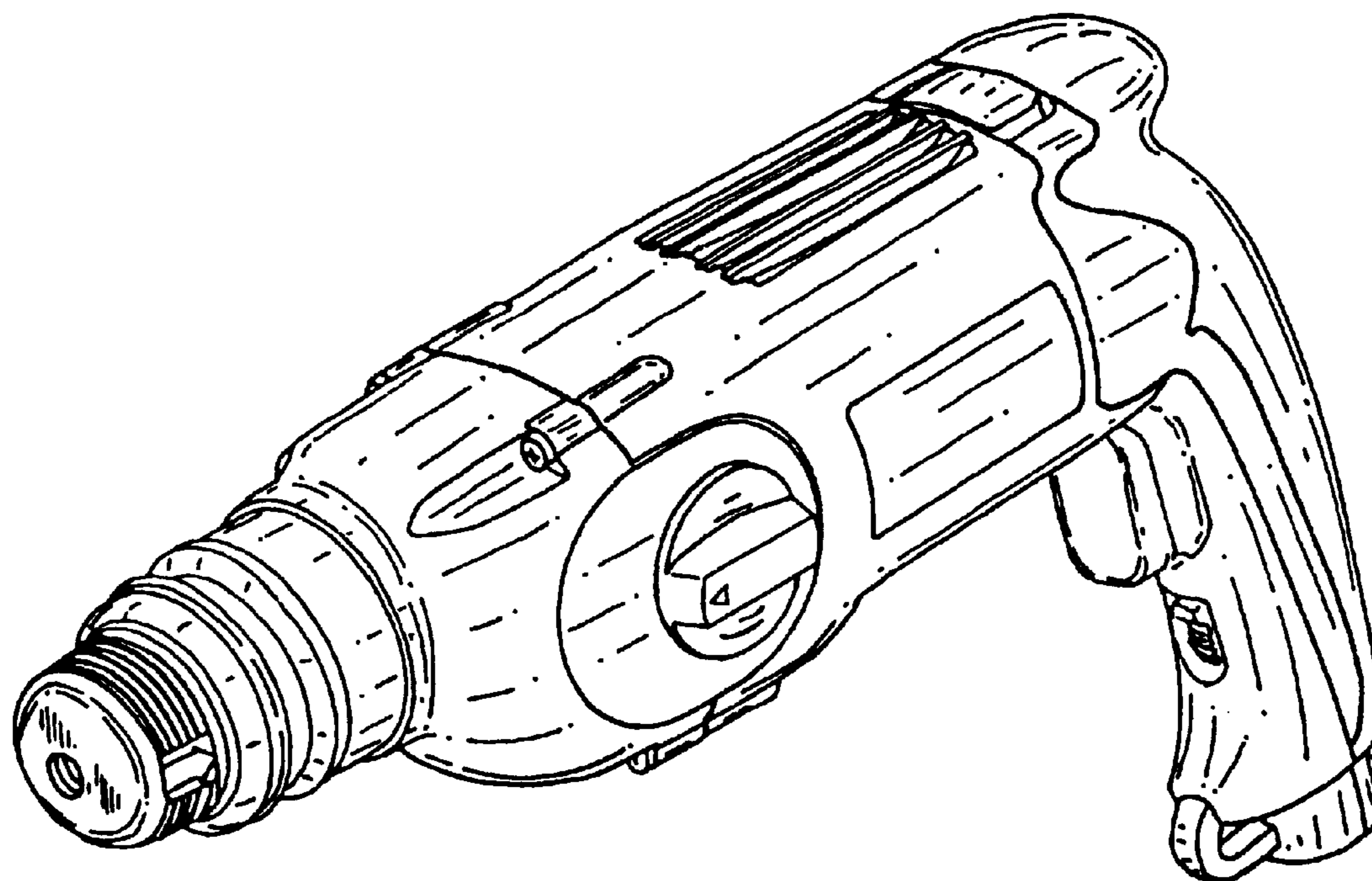

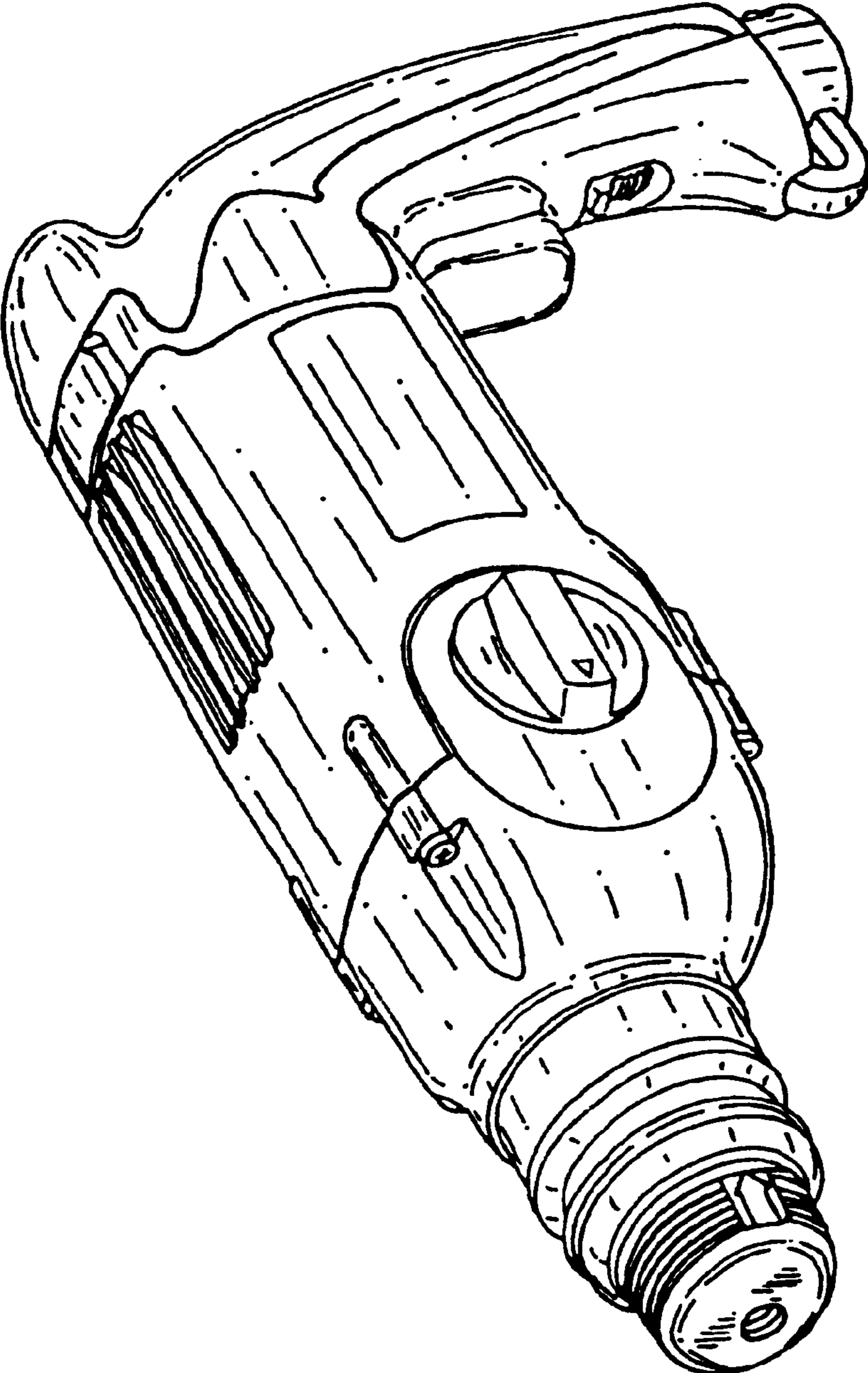

FIG. 1

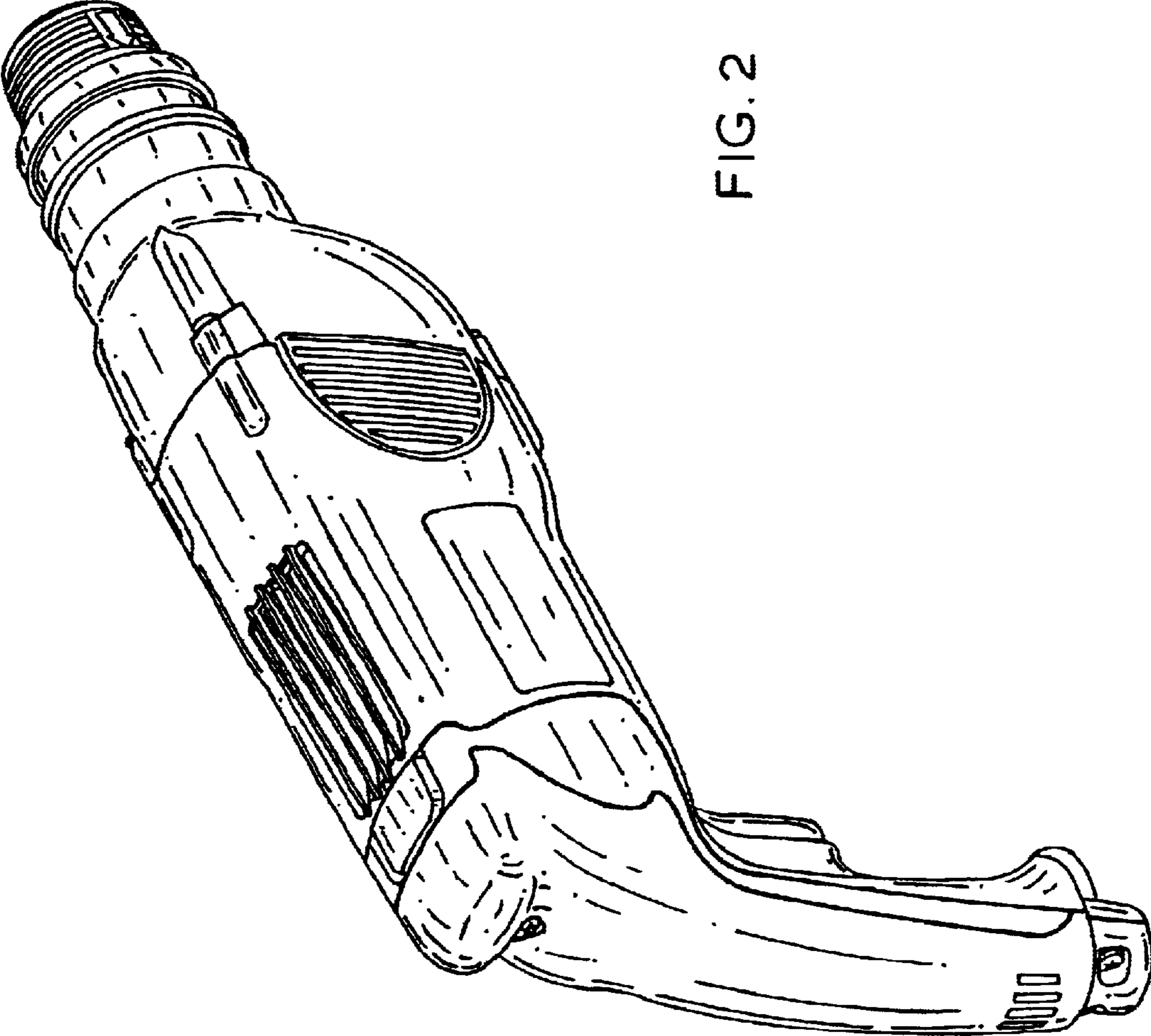

FIG. 2

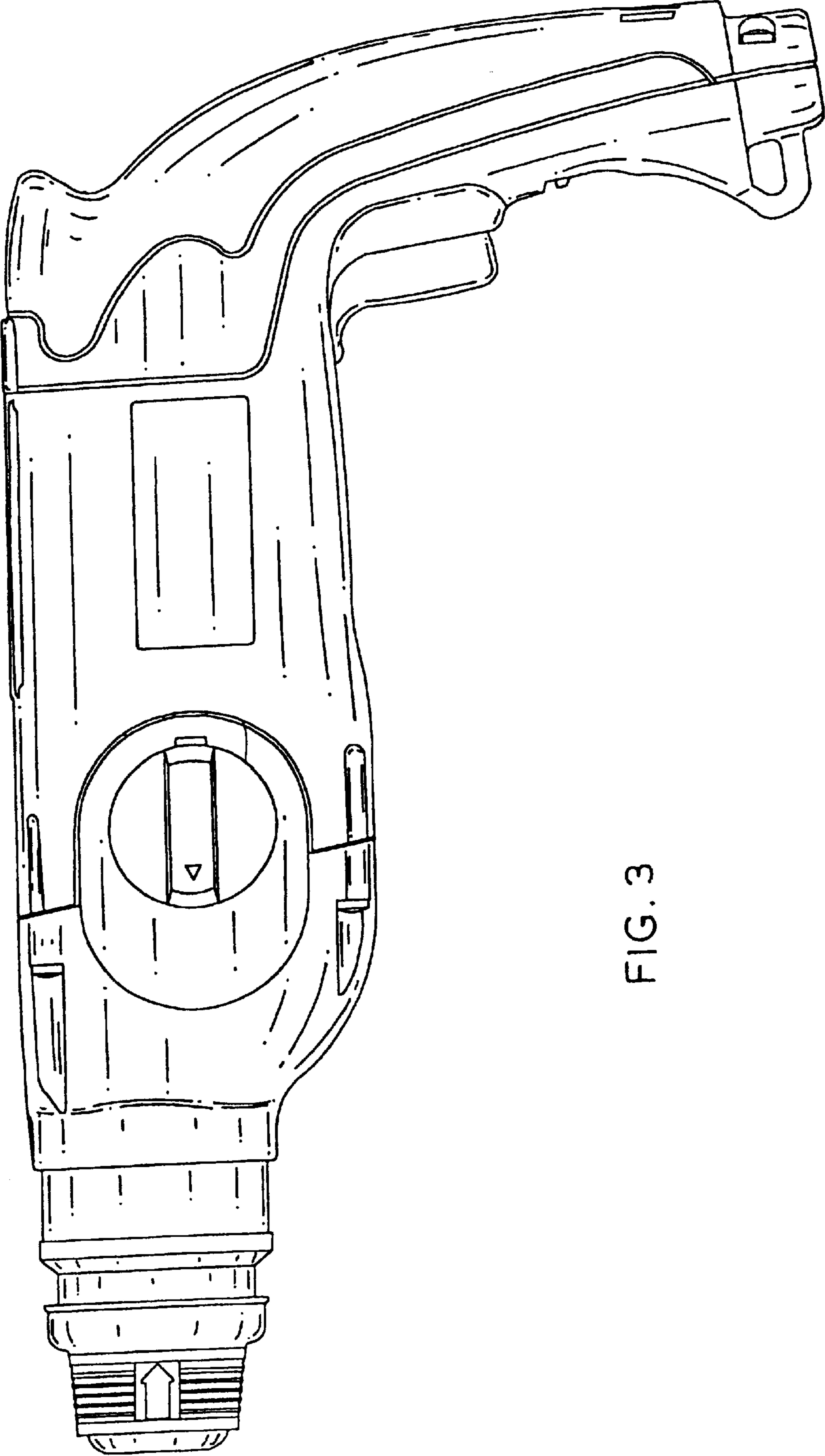

FIG. 3

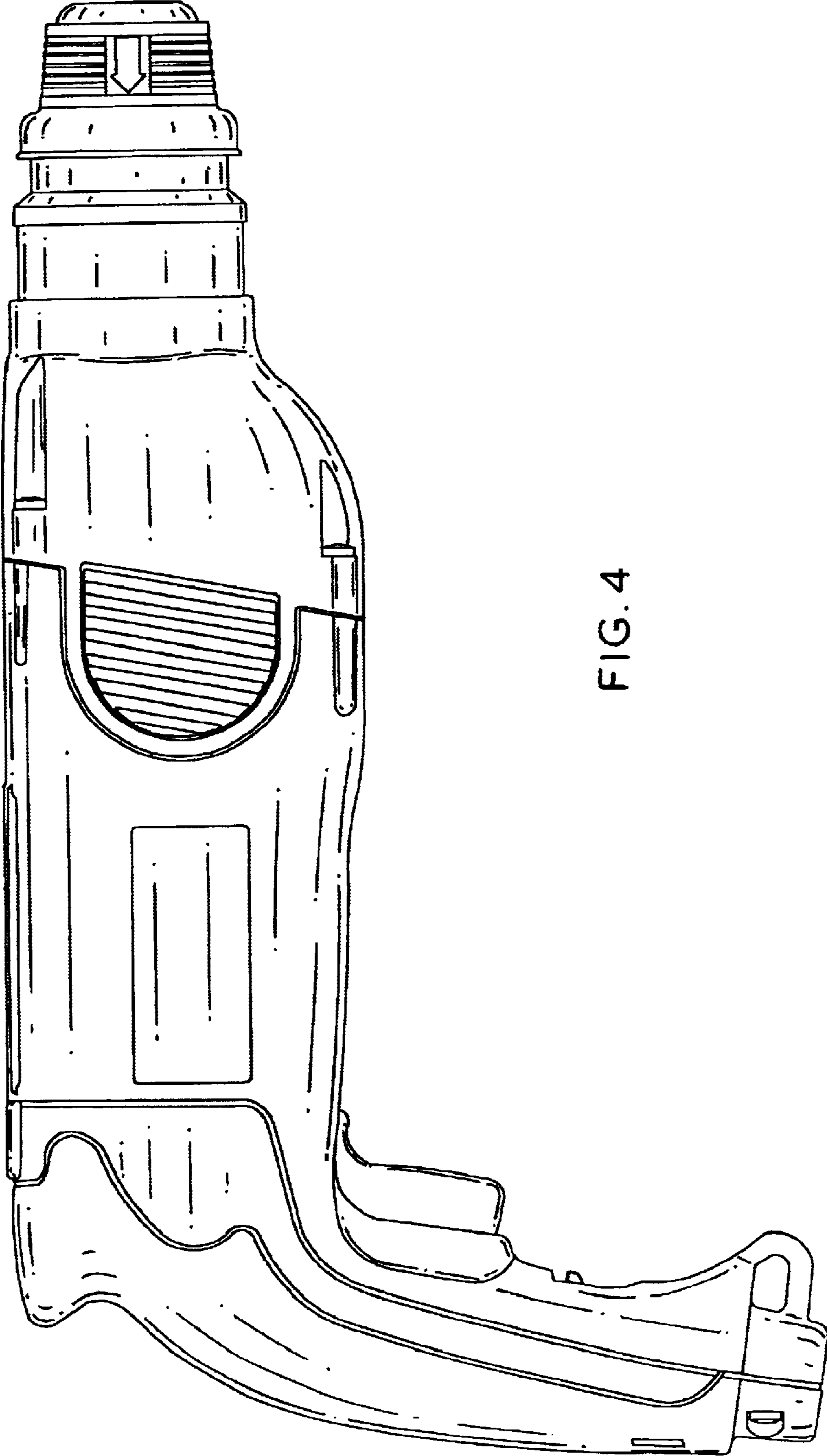

FIG. 4

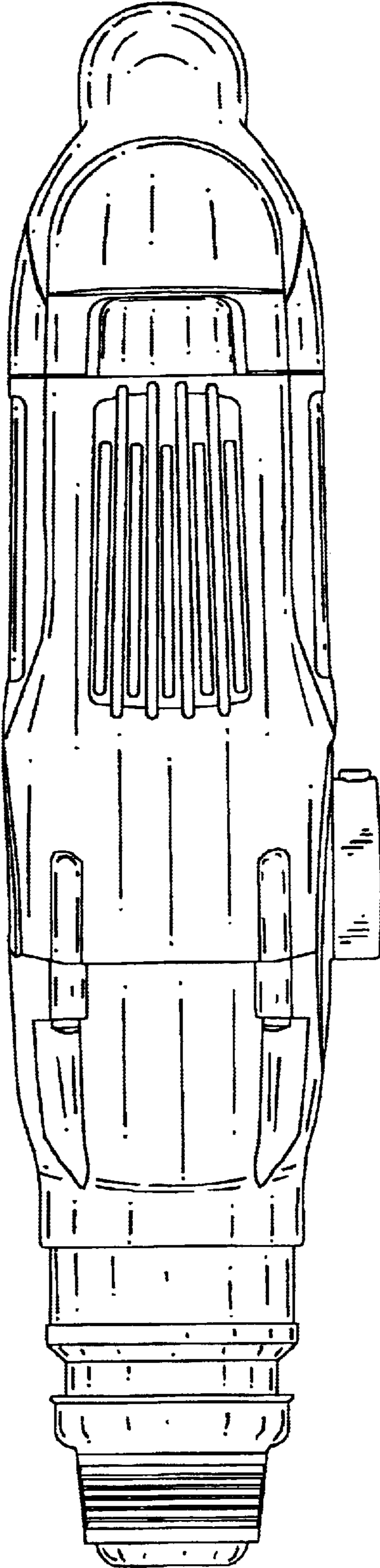

FIG. 5

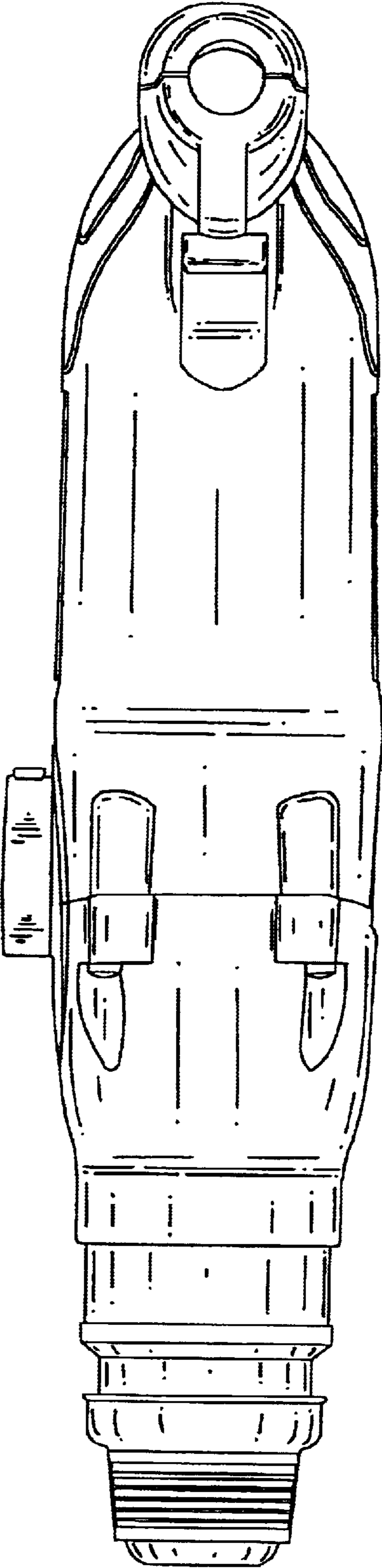

FIG. 6

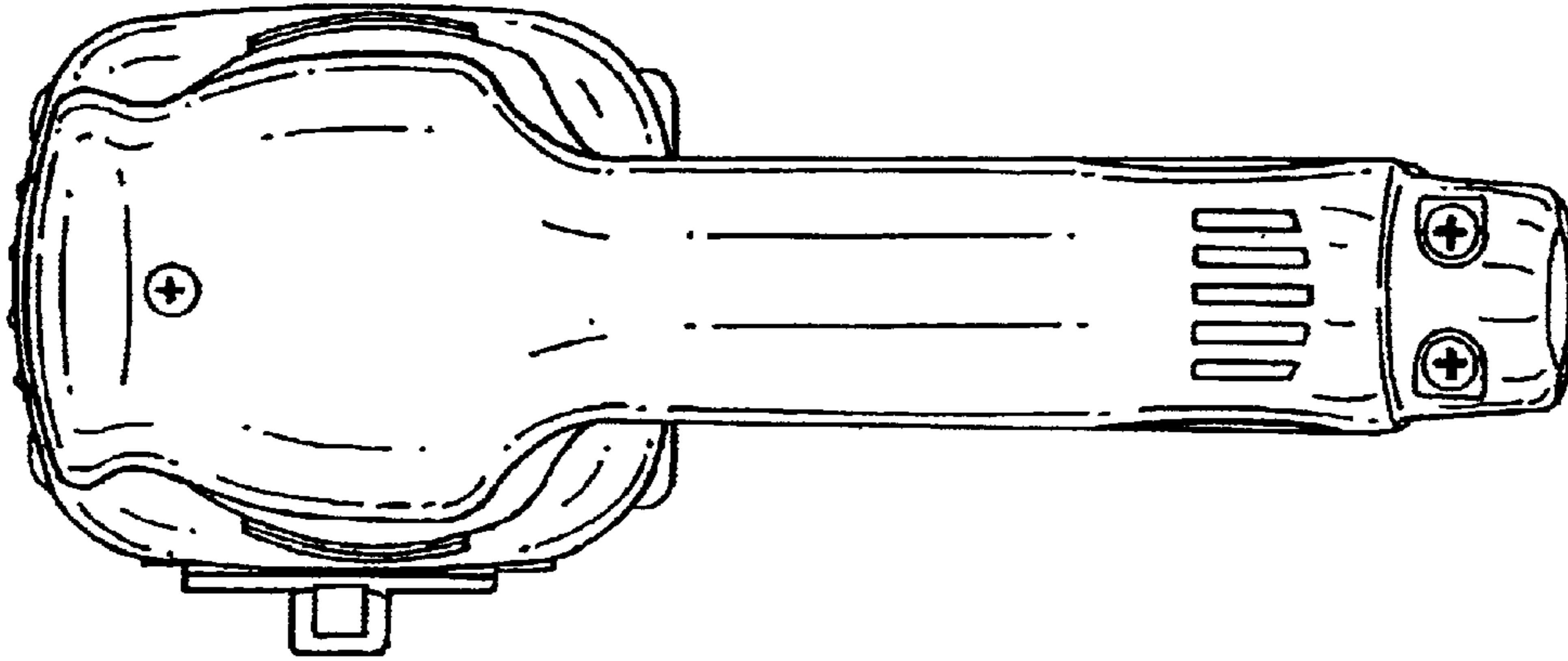

FIG. 8

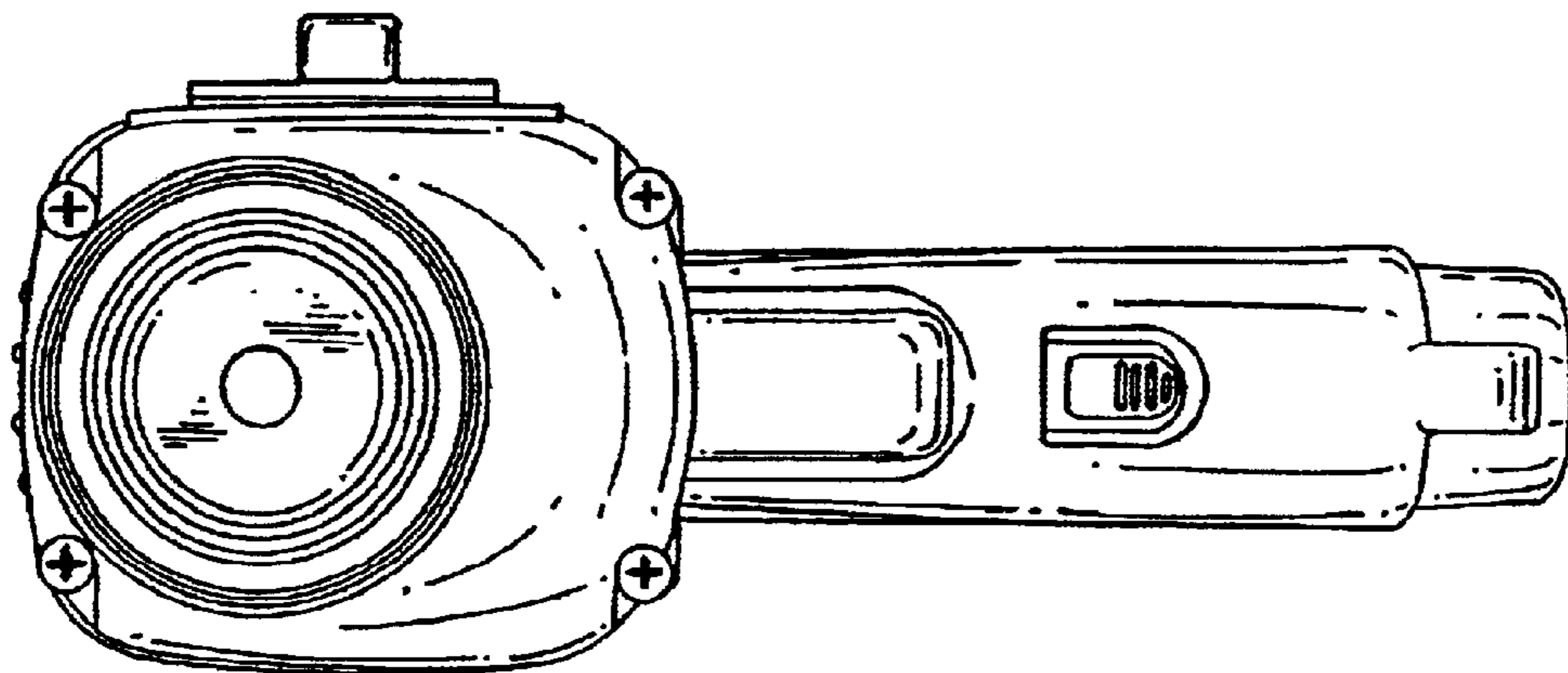

FIG. 7