

US00D492455S1

(12) **United States Design Patent**  
**Herrenbruck**

(10) **Patent No.: US D492,455 S**  
(45) **Date of Patent: \*\* Jun. 29, 2004**

(54) **TOY BALL**

(75) **Inventor: Rodney K. Herrenbruck, Chesterfield, MO (US)**

(73) **Assignee: Marketing and Creative Sales, Inc., Chesterfield, MO (US)**

(\*\*) **Term: 14 Years**

(21) **Appl. No.: 29/150,615**

(22) **Filed: Nov. 26, 2001**

**Related U.S. Application Data**

(63) Continuation-in-part of application No. 29/143,655, filed on Jun. 18, 2001, now Pat. No. Des. 454,993, which is a continuation of application No. 09/776,451, filed on Feb. 2, 2001, now Pat. No. 6,484,671.

(51) **LOC (7) Cl. .... 30-99**

(52) **U.S. Cl. .... D30/160; D21/713**

(58) **Field of Search .... D30/160; 119/702, 119/707-711; D24/211-212; 601/120-121, 118-119, 139; D21/713; D11/56, 103, 160; 273/153 R, 157 R, 153 P, 159**

(56) **References Cited**

**U.S. PATENT DOCUMENTS**

- 666,022 A 1/1901 Norris et al.
- D35,121 S \* 9/1901 Dawson et al. .... D11/103
- D74,213 S \* 1/1928 Cigol ..... D21/713
- 2,001,067 A \* 5/1935 Lane ..... 273/153 R
- D155,067 S \* 9/1949 Borrok ..... D11/160
- 3,648,403 A 3/1972 Gommel
- D241,869 S \* 10/1976 Hilprecht ..... D21/713
- 4,595,369 A 6/1986 Downs
- 5,343,828 A 9/1994 Houghton et al.
- 5,351,650 A \* 10/1994 Graves ..... 119/707
- 5,375,839 A 12/1994 Pagani
- D373,303 S \* 9/1996 Bailey ..... D8/373
- 5,575,240 A 11/1996 Udelle et al.
- 5,634,436 A 6/1997 Coombs et al.
- 5,758,604 A 6/1998 Jørgensen
- 5,794,568 A 8/1998 Udelle et al.

- 5,813,366 A 9/1998 Mauldin, Jr.
- 5,819,690 A \* 10/1998 Brown ..... 119/707
- 5,832,877 A 11/1998 Markham
- 5,865,147 A 2/1999 Rubin
- 5,947,061 A 9/1999 Markham et al.
- 5,957,082 A 9/1999 Budman et al.
- 5,965,182 A 10/1999 Lindgren
- D421,078 S \* 2/2000 Weiss, Jr. .... D21/713
- 6,073,581 A \* 6/2000 Wang ..... 119/711
- 6,098,571 A 8/2000 Axelrod et al.

(List continued on next page.)

**OTHER PUBLICATIONS**

R.C.Steele Pet Supplies Catalog; p. 72; Treats and Training Ball #LF20-5179/#LF20-5190; bottom, right corner on page.\*

R.C. Steele Online Pet Supplies, Internet online pet supply advertisement for "Wiggly Giggly" pet toy, available on-line at www.rcsteele.com/ on Nov. 18, 2000.

Product tag—Play-N-Speak™ Toy; Copyright Notice 2000.

*Primary Examiner*—Cathy Anne MacCormac

(74) *Attorney, Agent, or Firm*—Senniger, Powers, Leavitt & Roedel

(57) **CLAIM**

The ornamental design for a toy ball, as shown and described.

**DESCRIPTION**

FIG. 1 is a front elevation view of a toy ball showing my new design;

FIG. 2 is a rear elevation view thereof;

FIG. 3 is a left side elevation view thereof;

FIG. 4 is a right side elevation view thereof;

FIG. 5 is a bottom plan view thereof;

FIG. 6 is a top plan view thereof;

FIG. 7 is a perspective view thereof; and,

FIG. 8 is a fragmentary cross section view thereof taken on line 8—8 of FIG. 7.

The broken lines shown in the drawings indicate environmental structure which form no part of the claimed design.

**1 Claim, 8 Drawing Sheets**

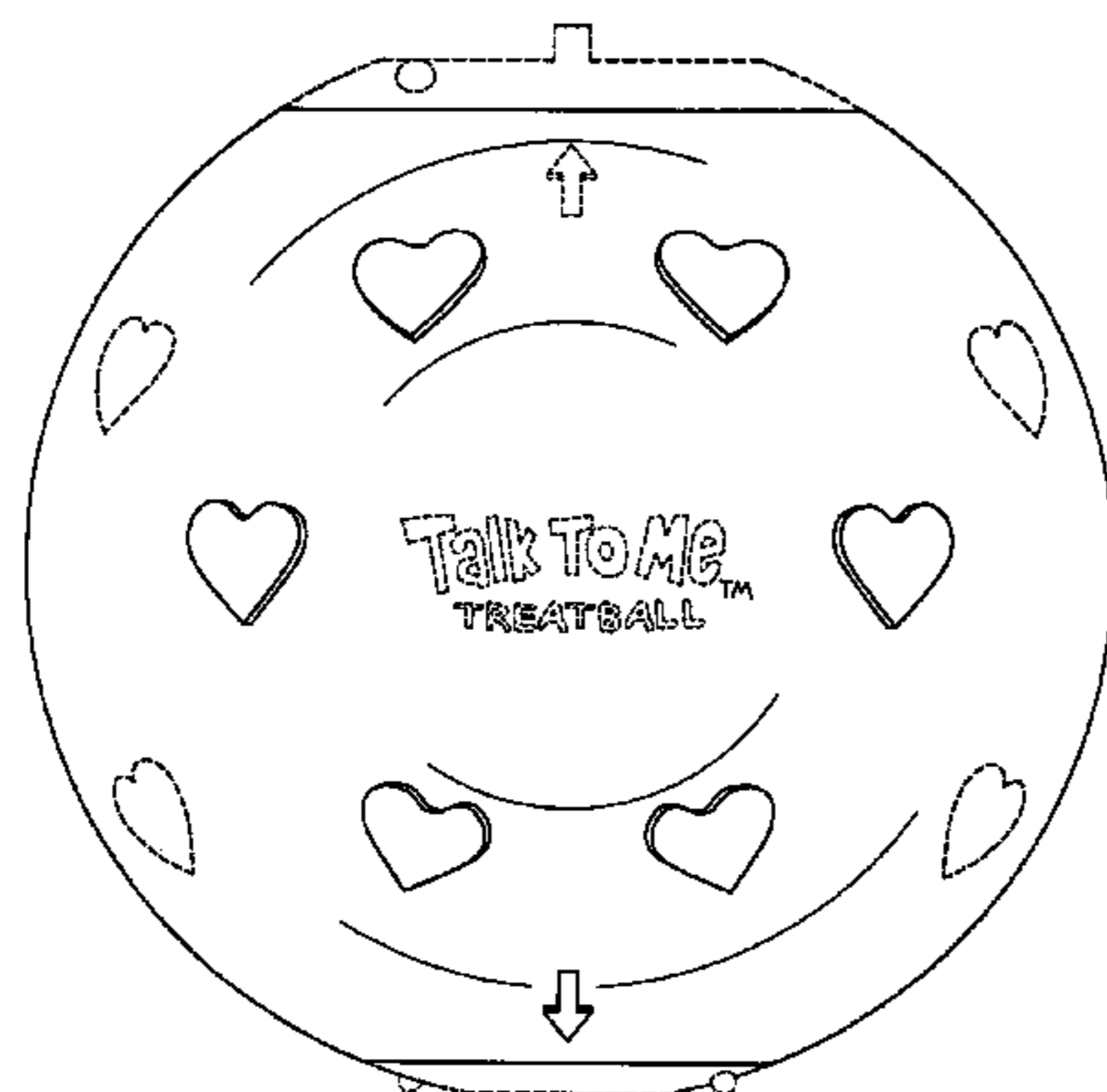

# US D492,455 S

Page 2

---

## U.S. PATENT DOCUMENTS

D433,084 S	*	10/2000	Hart	.....	D21/713	D453,240 S	*	1/2002	Simon	.....	D30/160
6,129,053 A	*	10/2000	Markham et al.	.....	119/710	6,439,166 B1	*	8/2002	Markham	.....	119/709
6,158,390 A		12/2000	Holtier et al.			2001/0027754 A1		10/2001	Tsengas		
6,237,538 B1		5/2001	Tsengas								

\* cited by examiner

FIG. 1

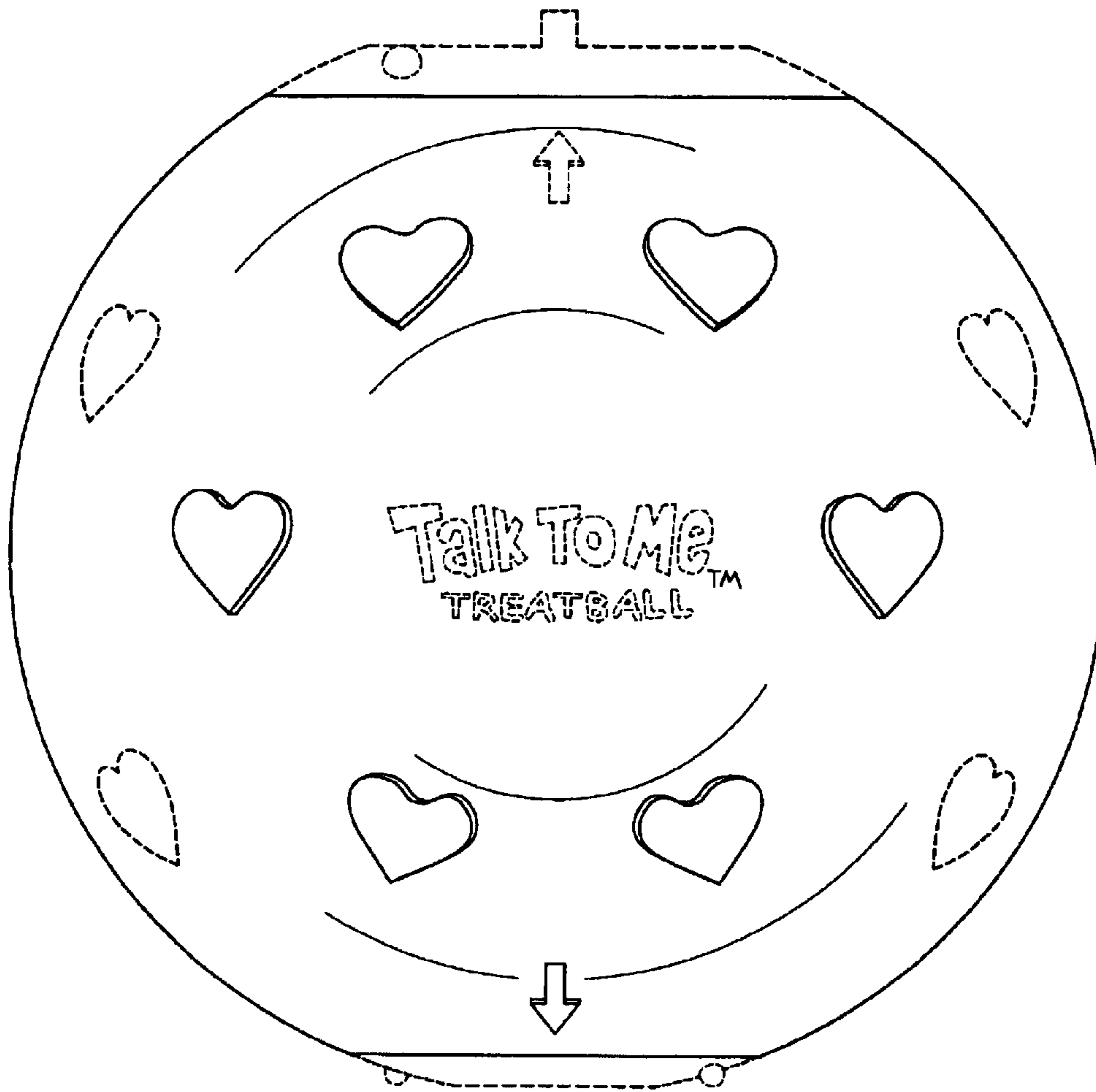

FIG. 2

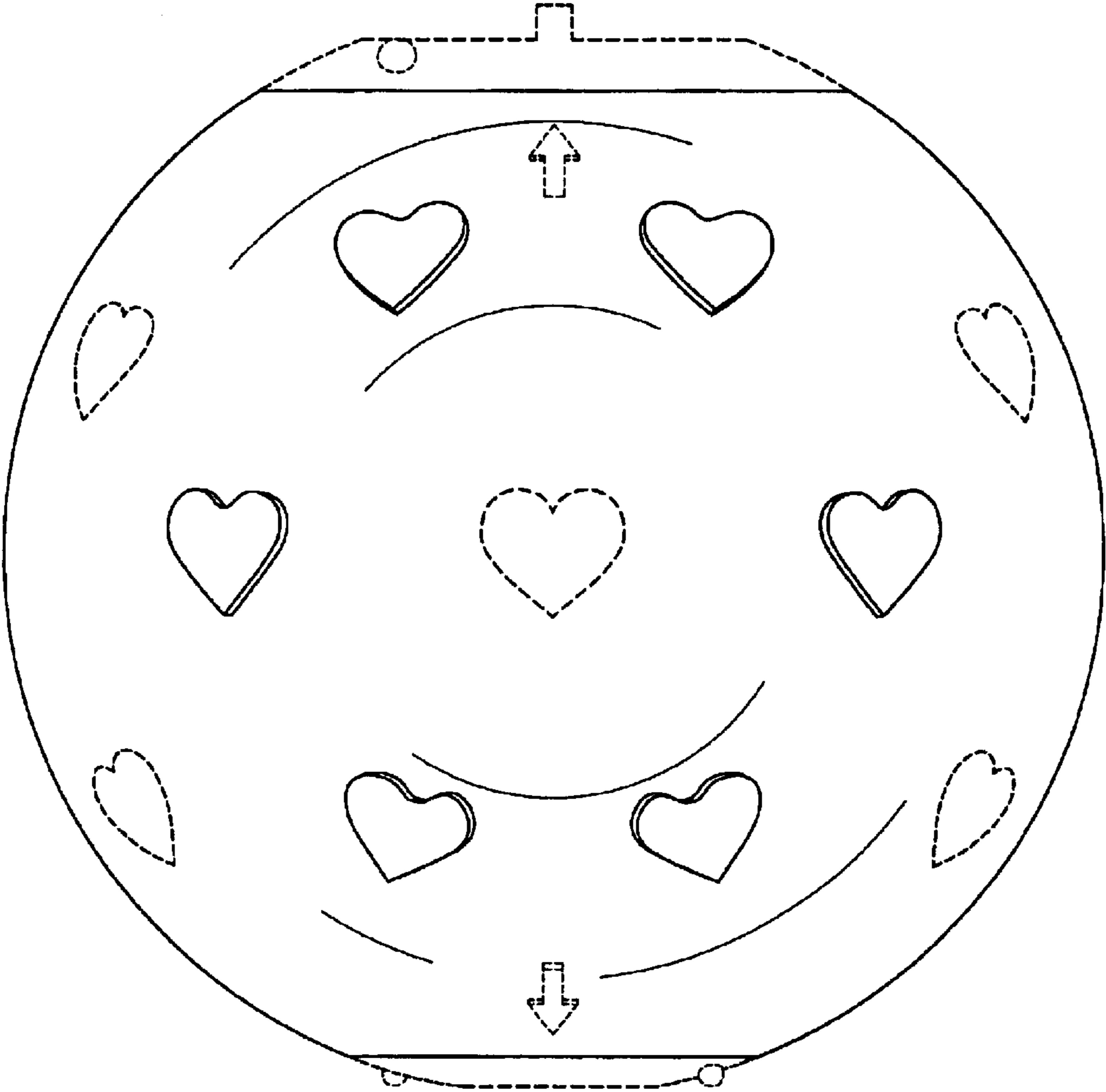

FIG. 3

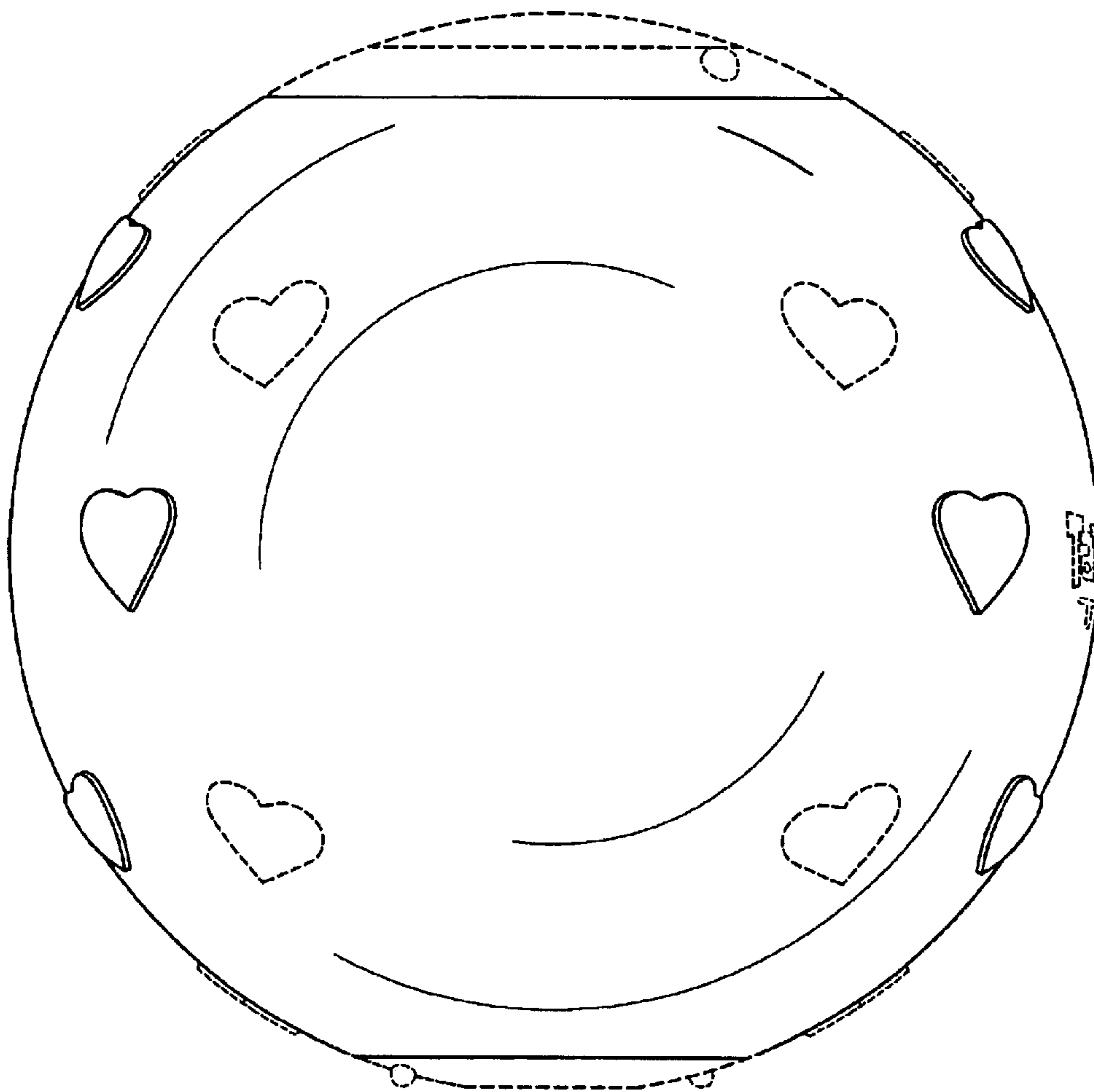

FIG. 4

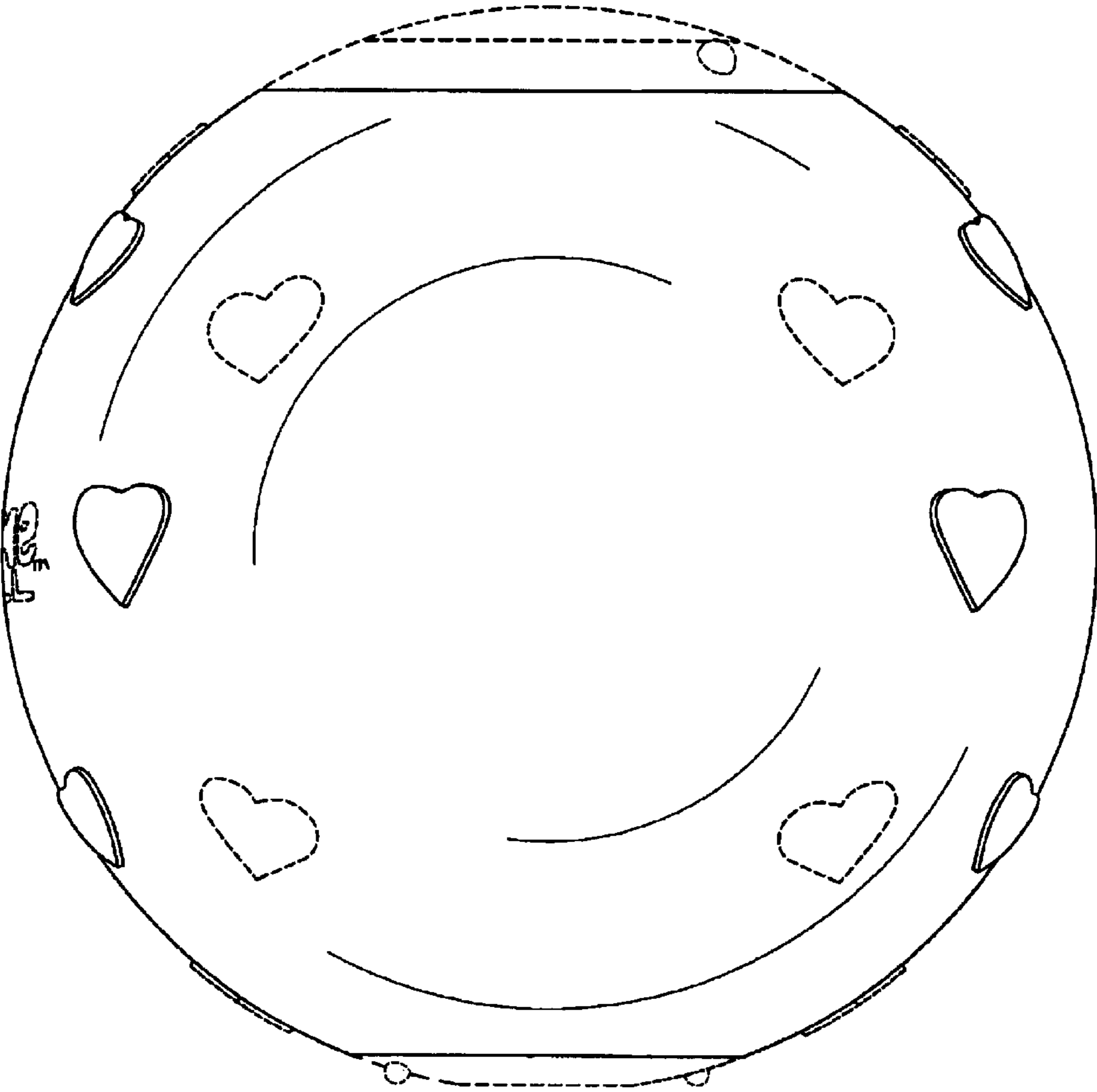

FIG. 5

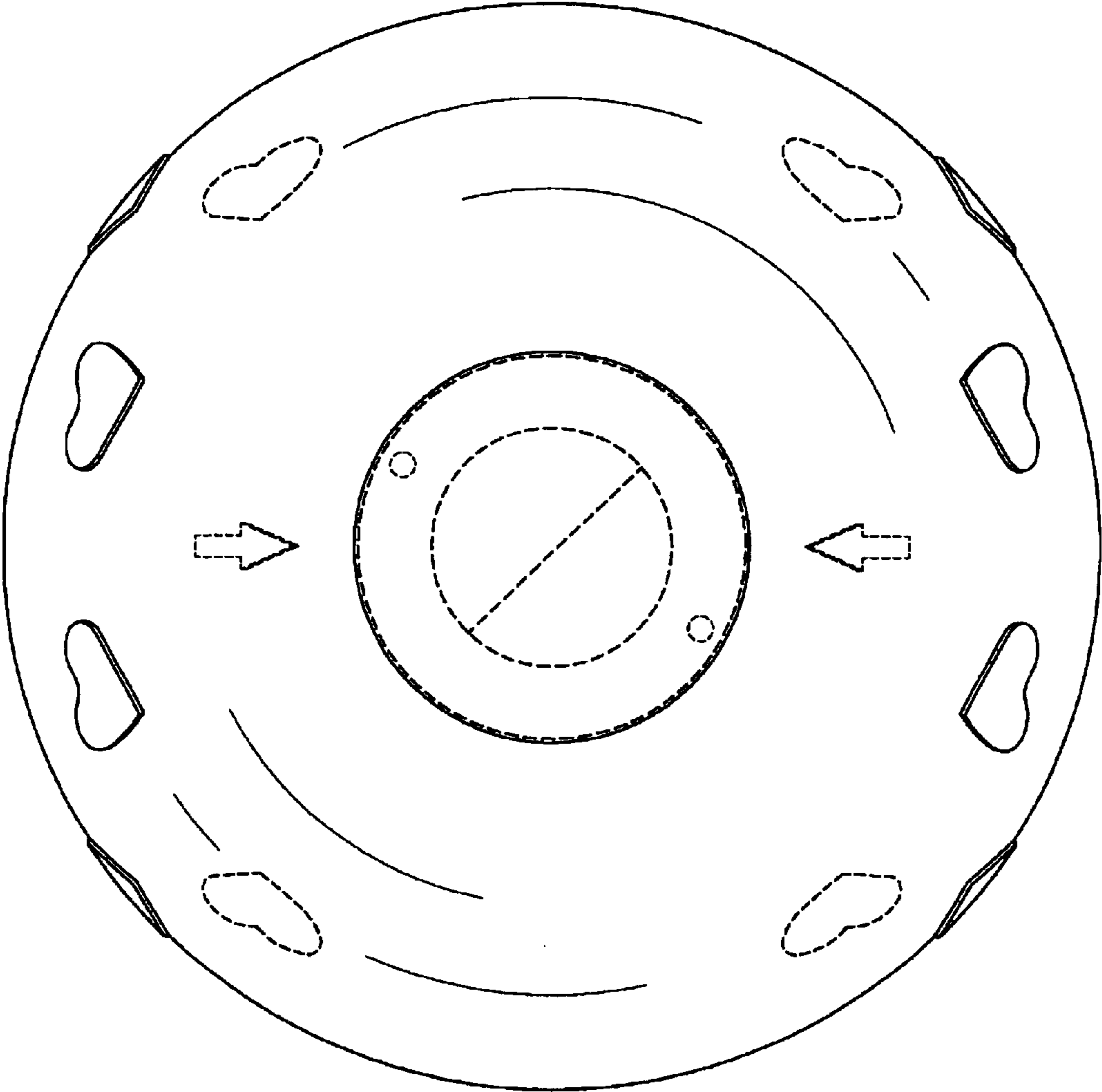

FIG. 6

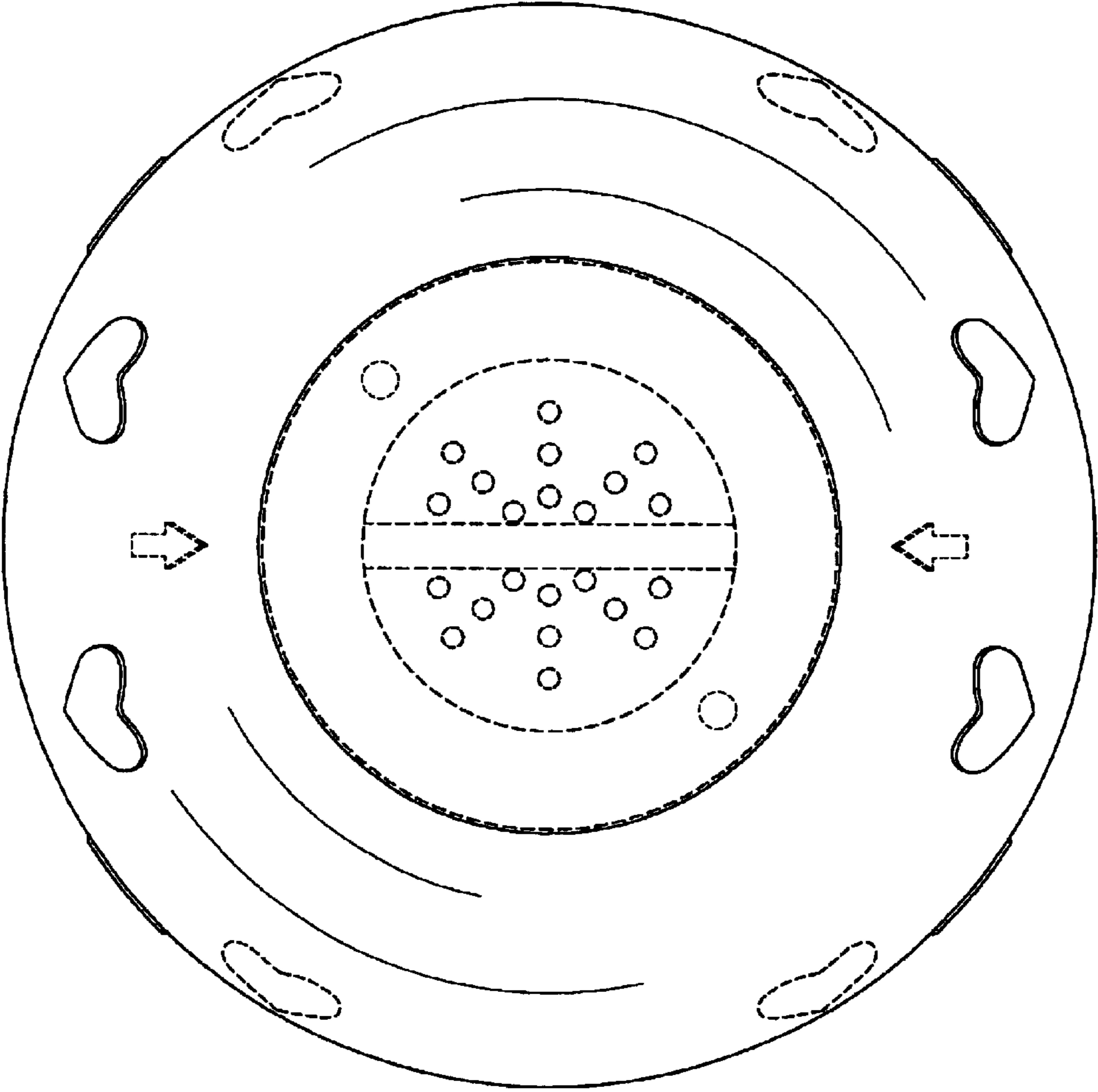



FIG. 7



FIG. 8

