

US00D492422S1

(12) **United States Design Patent**
De Lorenzo

(10) **Patent No.:** **US D492,422 S**
(45) **Date of Patent:** **** Jun. 29, 2004**

(54) **BELT POST FOR CROWD CONTROL**

(76) **Inventor:** **Ricardo Augusto De Lorenzo, Av.**
Eliseu de Almeida, Sao Paulo (BR),
1103

(**) **Term:** **14 Years**

(21) **Appl. No.:** **29/176,727**

(22) **Filed:** **Feb. 25, 2003**

(51) **LOC (7) Cl.** **25-02**

(52) **U.S. Cl.** **D25/51**

(58) **Field of Search** D25/50-51; 256/1,
256/16; 40/46-47

(56) **References Cited**

U.S. PATENT DOCUMENTS

5,050,846 A * 9/1991 Goodman et al. 256/1
D343,690 S * 1/1994 Carey D25/51

* cited by examiner

Primary Examiner—Doris Clark

(74) *Attorney, Agent, or Firm*—McCormick, Paulding &
Huber LLP

(57) **CLAIM**

The ornamental design for a belt post for crowd control, as
shown and described.

DESCRIPTION

FIG. 1 is a perspective view of my ornamental design for the
belt post for crowd control;
FIG. 2 is a frontal elevational view thereof;
FIG. 3 is a side elevational view thereof;
FIG. 4 is a top plan view thereof;
FIG. 5 is a bottom plan view thereof; and,
FIG. 6 is a cross sectional view taken along line 6—6 of FIG.
2.

1 Claim, 3 Drawing Sheets

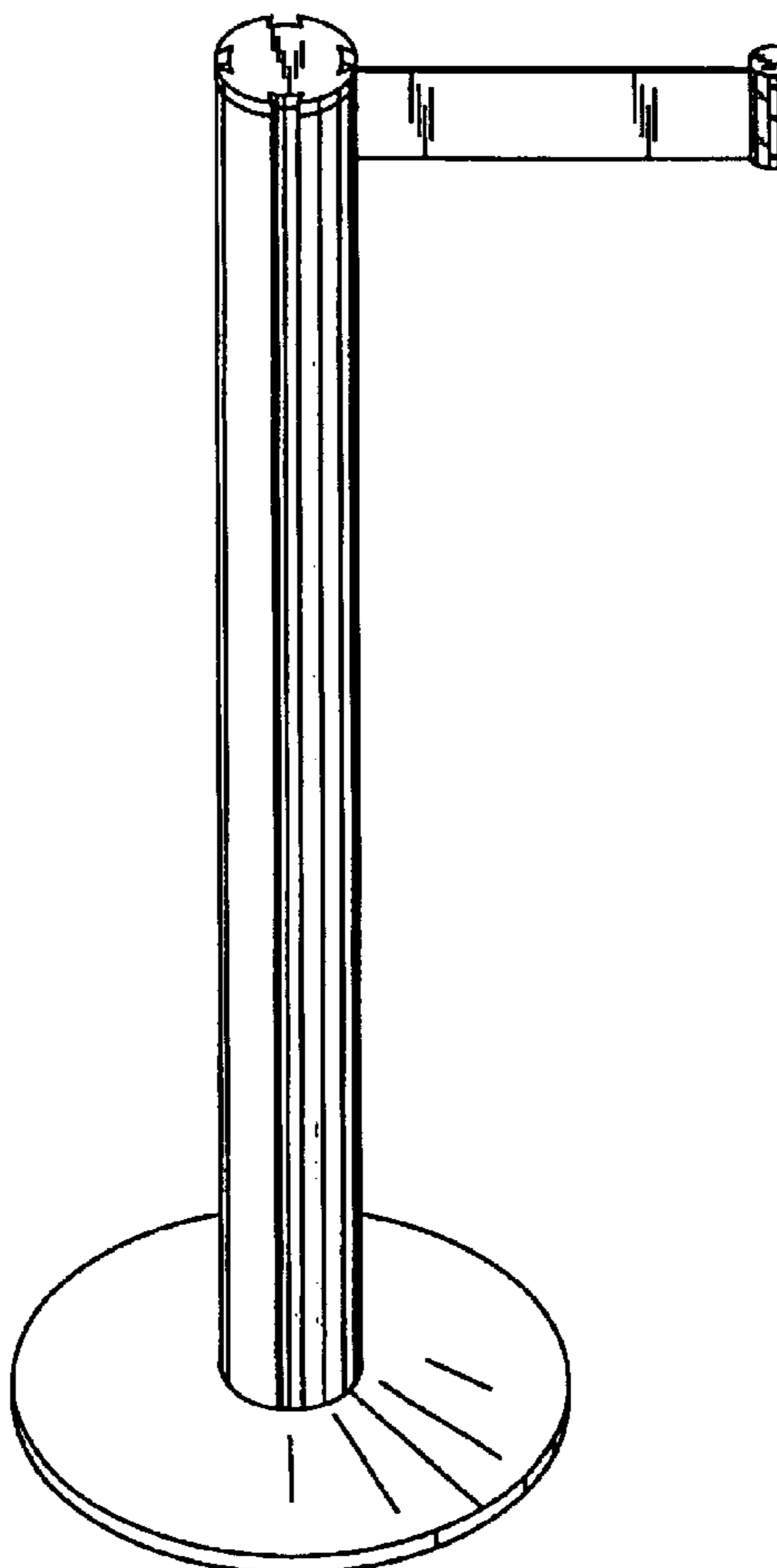

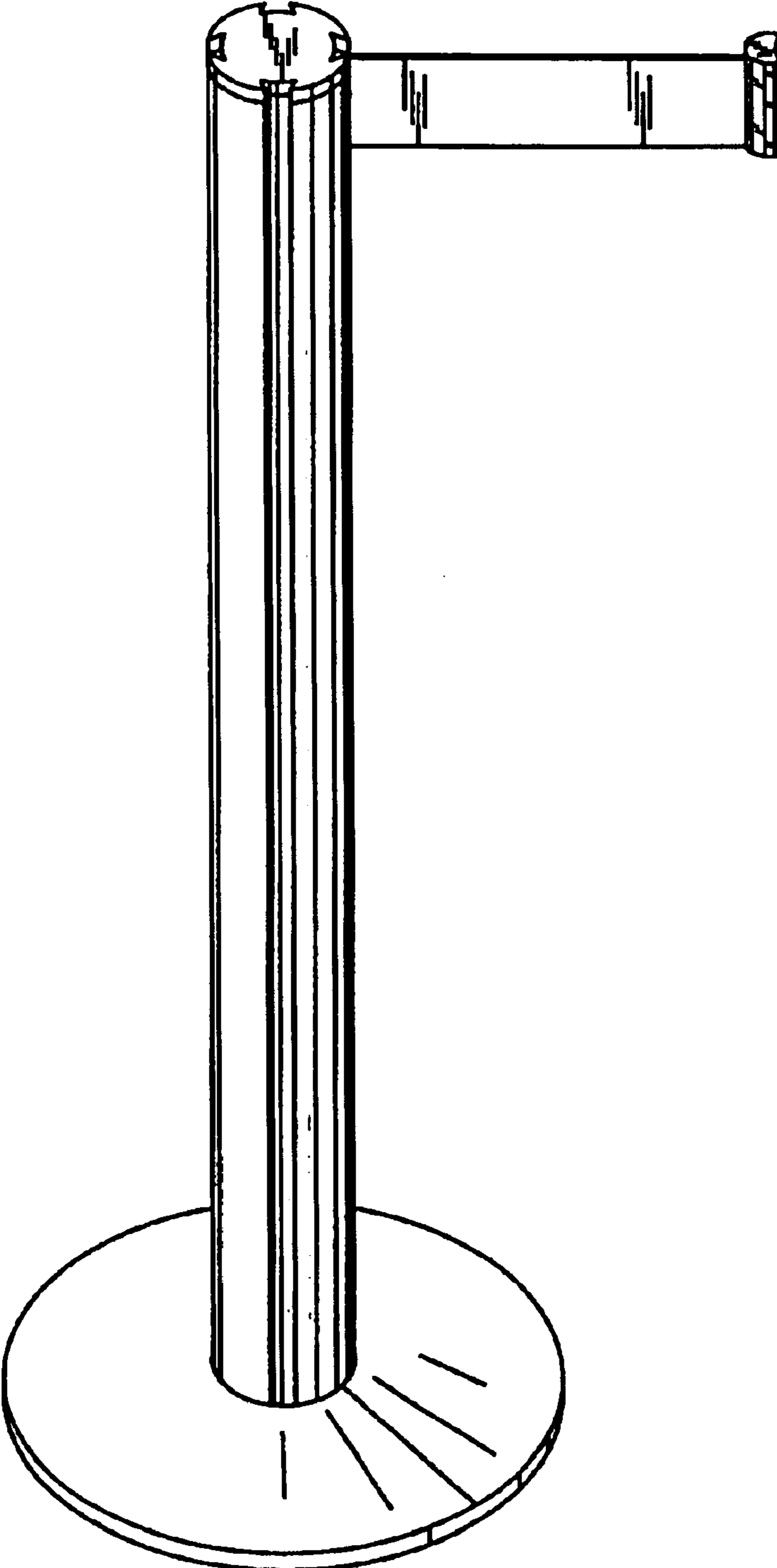

FIG. 1

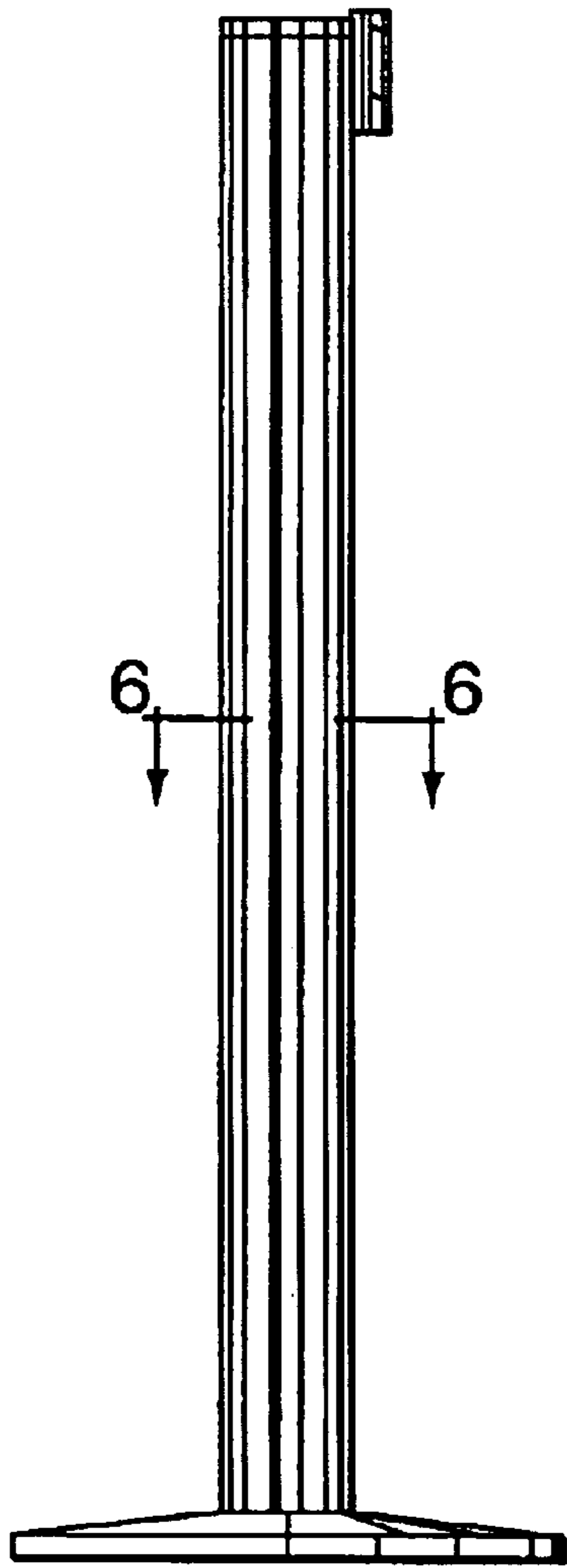

FIG. 2

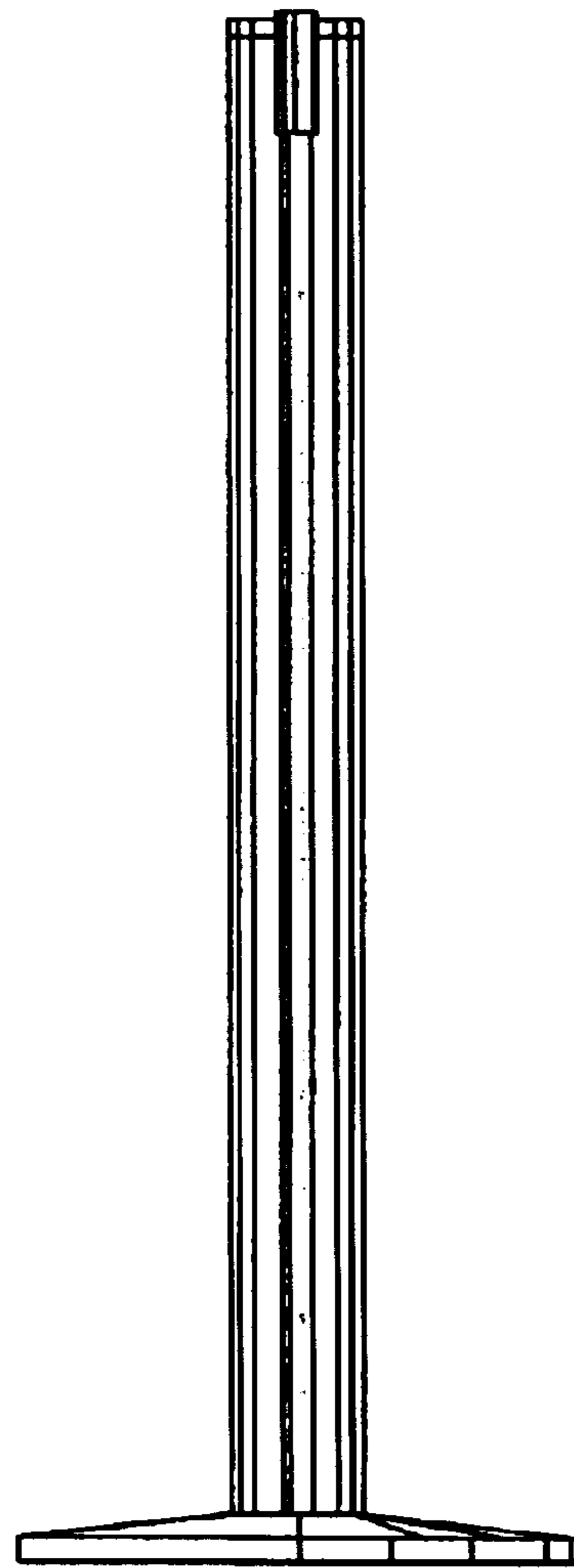

FIG. 3

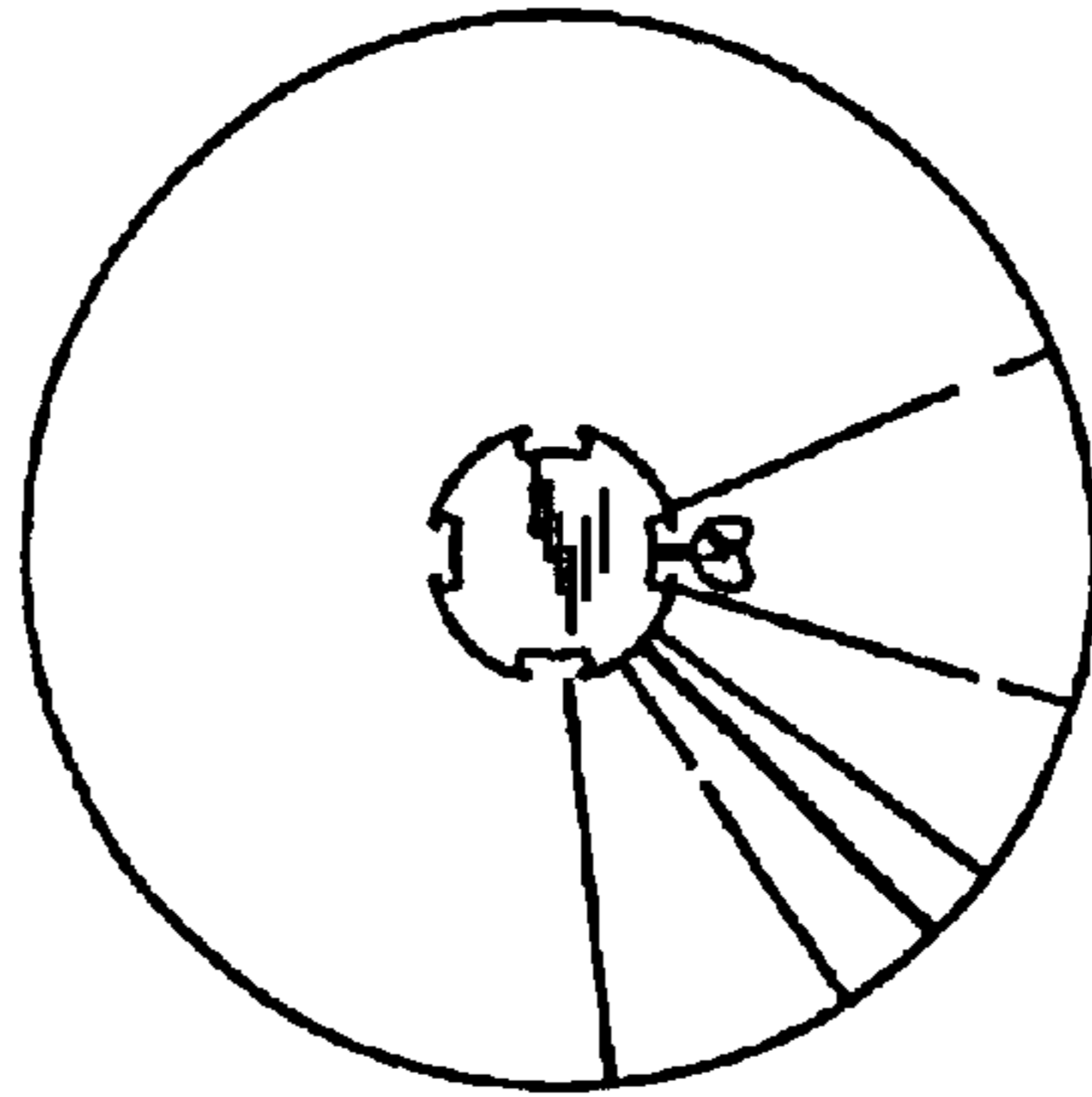

FIG. 4

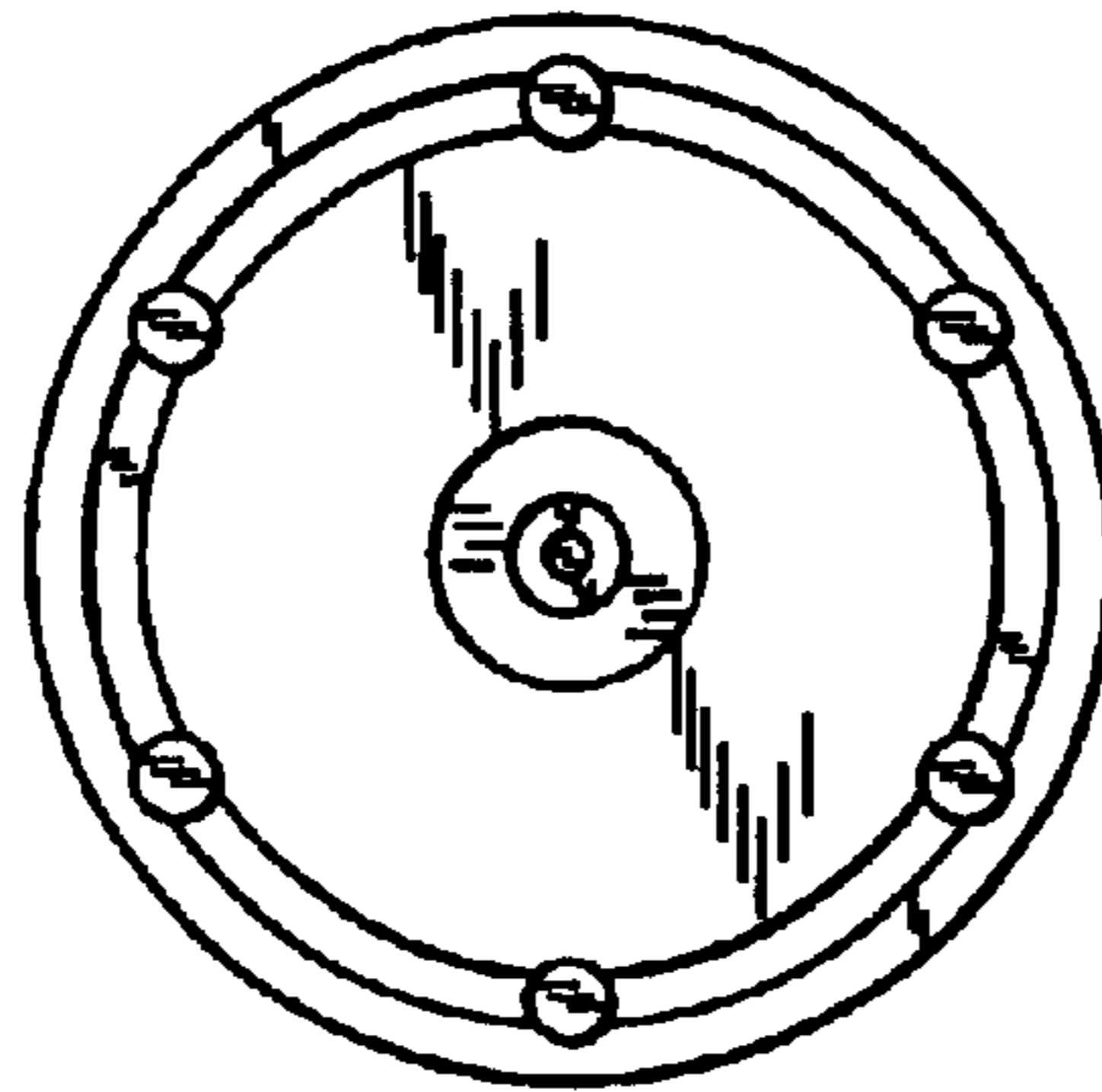

FIG. 5

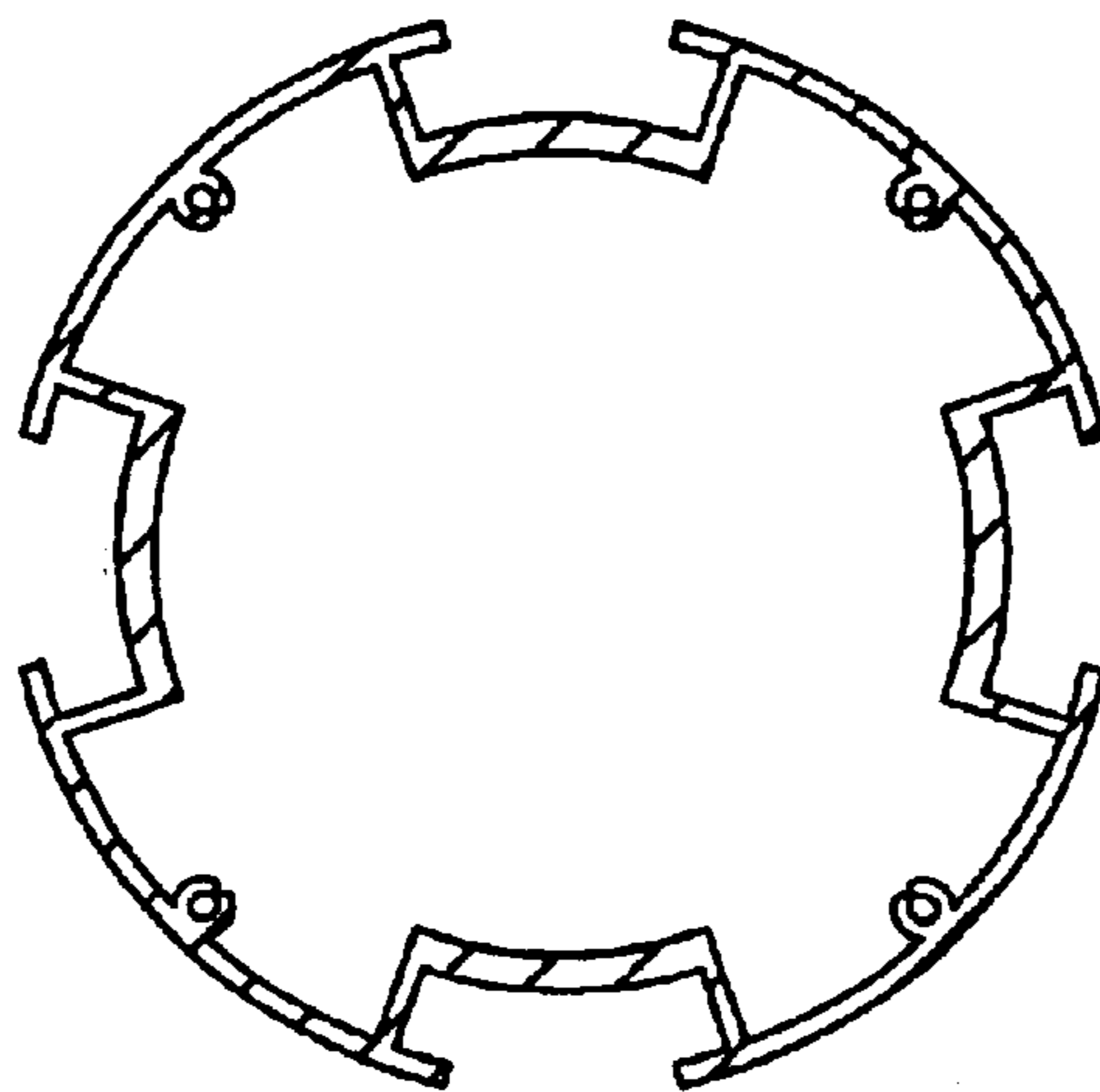

FIG. 6