

US00D492405S1

(12) **United States Design Patent**
Bainton

(10) **Patent No.:** **US D492,405 S**

(45) **Date of Patent:** **** Jun. 29, 2004**

(54) **PEN-TYPE INJECTOR**

(75) **Inventor:** **Michael Cameron Bainton,**
Warwickshire (GB)

(73) **Assignee:** **DCA Design International Limited,**
Warwick (GB)

(**) **Term:** **14 Years**

(21) **Appl. No.:** **29/180,281**

(22) **Filed:** **Apr. 22, 2003**

(30) **Foreign Application Priority Data**

Nov. 9, 2002 (GB) 3 008 497

(51) **LOC (7) Cl.** **24-02**

(52) **U.S. Cl.** **D24/114; D19/43; D24/112;**
D24/113

(58) **Field of Search** D24/114, 113,
D24/112, 146; D19/43, 51, 55, 57; 604/211,
209, 218, 207, 208, 506, 65, 185, 198,
132, 136, 135, 137, 134

(56) **References Cited**

U.S. PATENT DOCUMENTS

6,110,149 A * 8/2000 Klitgaard et al. 604/209
6,193,698 B1 * 2/2001 Kirchhofer et al. 604/211
D462,760 S * 9/2002 Ahlgrim et al. D24/114

D479,599 S * 9/2003 Bainton D24/114
D479,603 S * 9/2003 Tyce D24/114
D479,747 S * 9/2003 Bainton D24/114

* cited by examiner

Primary Examiner—Ian Simmons

(74) *Attorney, Agent, or Firm*—Oliff & Berridge, PLC

(57) **CLAIM**

The ornamental design for a pen-type injector, as shown and described.

DESCRIPTION

FIG. 1 is a perspective view of a pen-type injector;
FIG. 2 is a front view thereof;
FIG. 3 is a rear view thereof;
FIG. 4 is a right-side view thereof;
FIG. 5 is a left-side view thereof;
FIG. 6 is a top view thereof;
FIG. 7 is a bottom view thereof;
FIG. 8 is a perspective view thereof with a cap removed;
FIG. 9 is a front view thereof with a cap removed;
FIG. 10 is a rear view thereof with a cap removed;
FIG. 11 is a right-side view thereof with a cap removed;
FIG. 12 is a left-side view thereof with a cap removed;
FIG. 13 is a top view thereof with a cap removed; and,
FIG. 14 is a bottom view thereof with a cap removed.

1 Claim, 12 Drawing Sheets

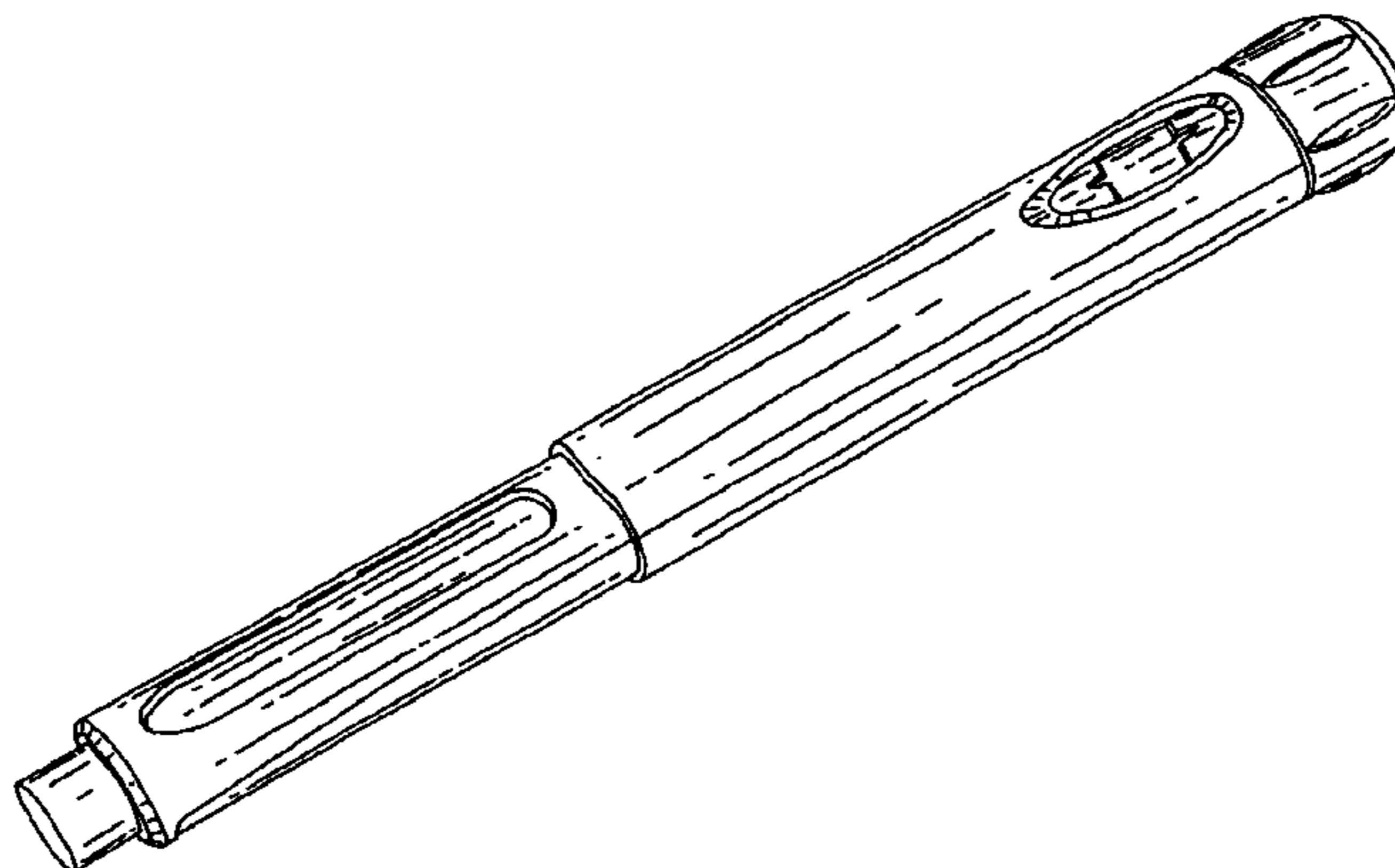
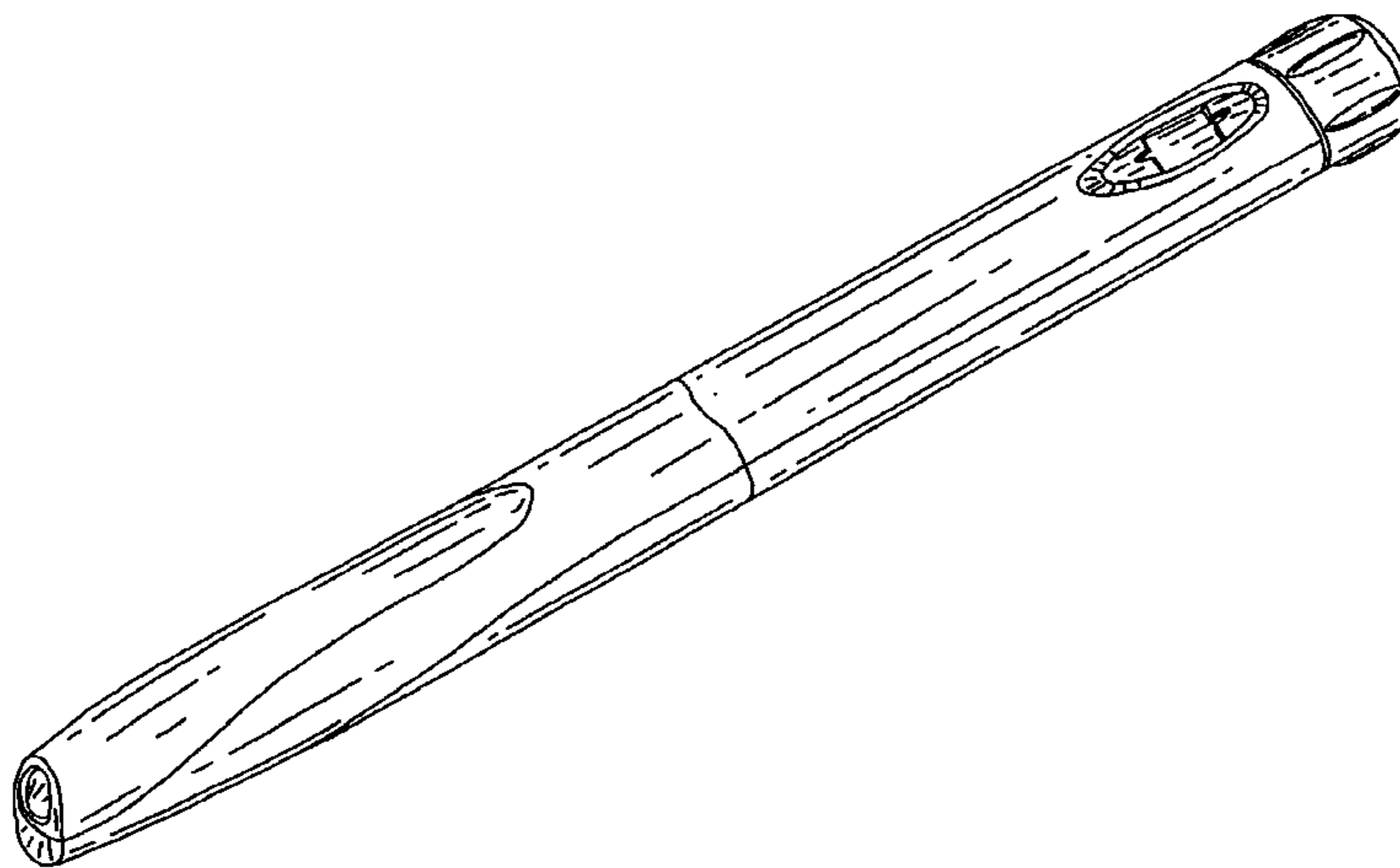

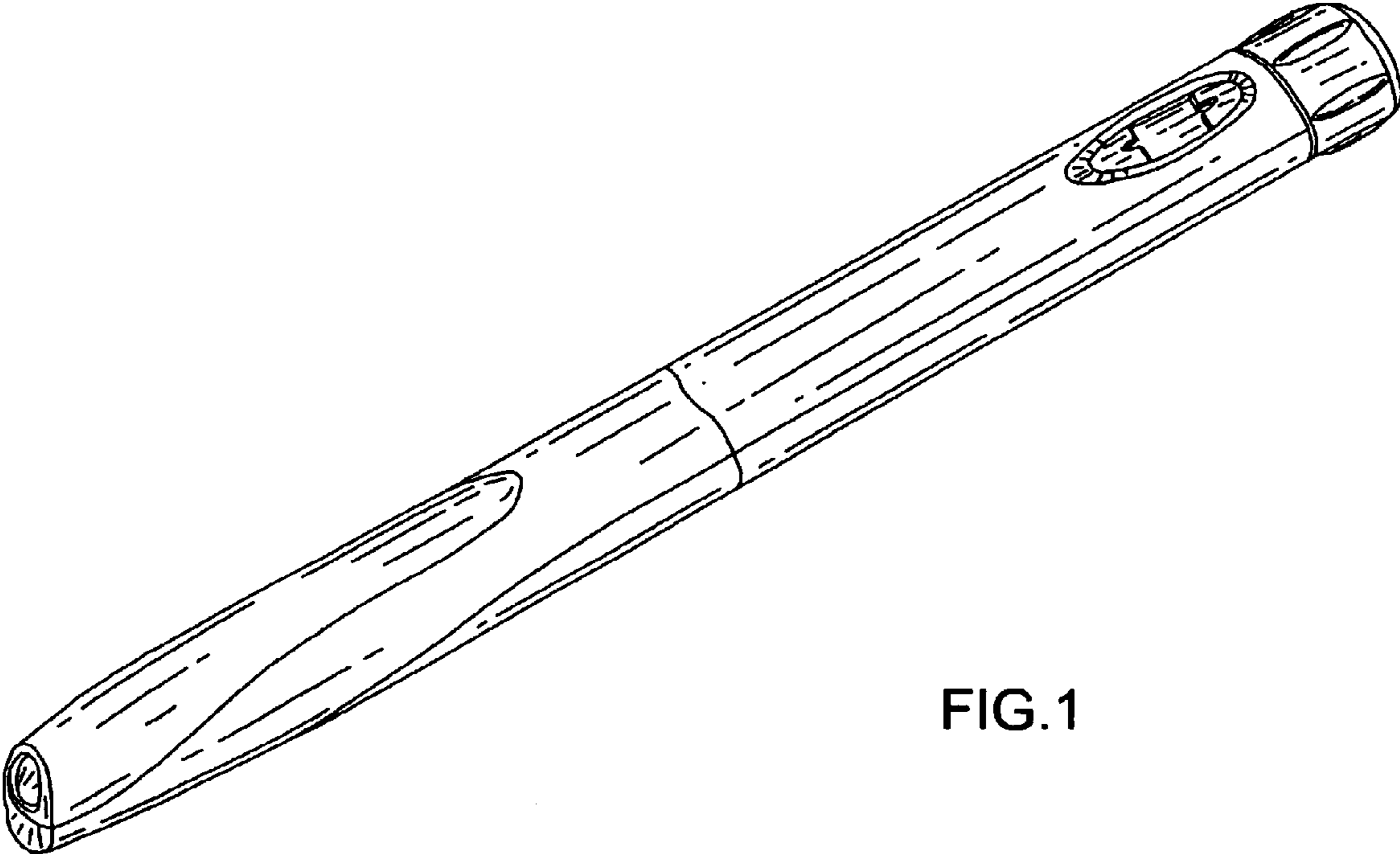

FIG. 1

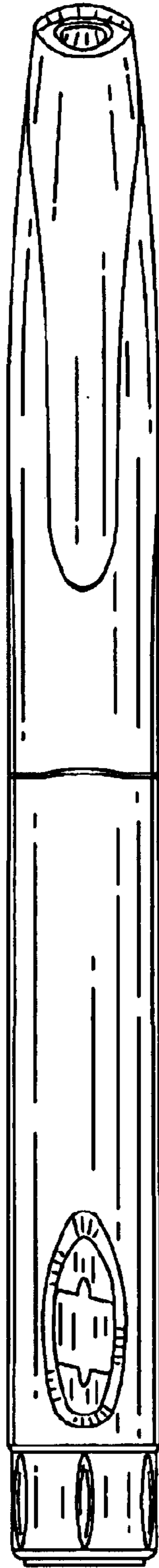

FIG.2

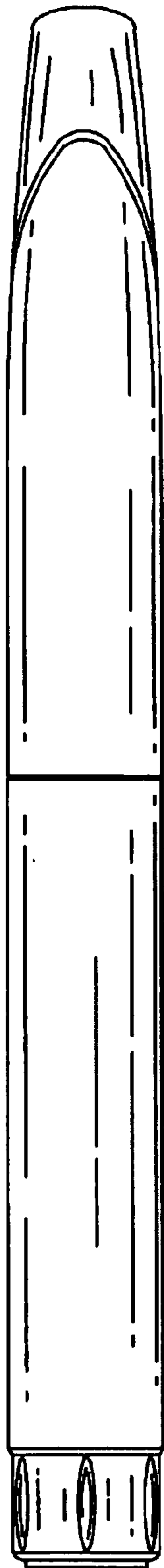

FIG.3

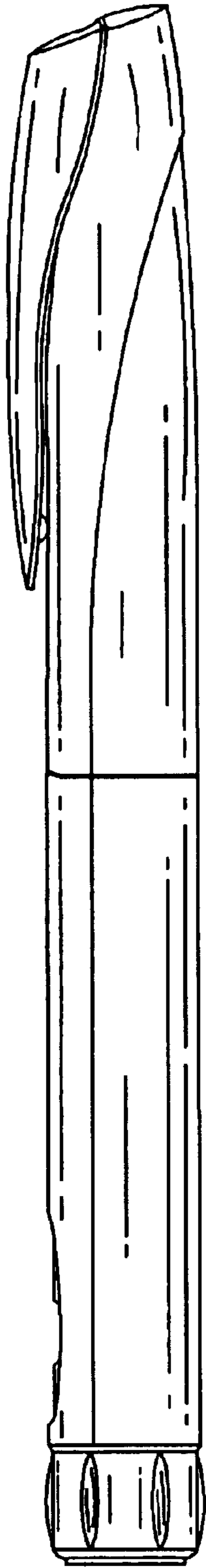

FIG.4

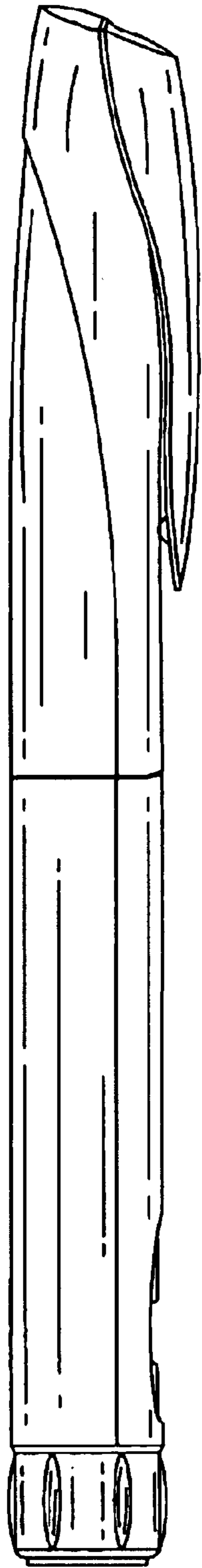

FIG.5

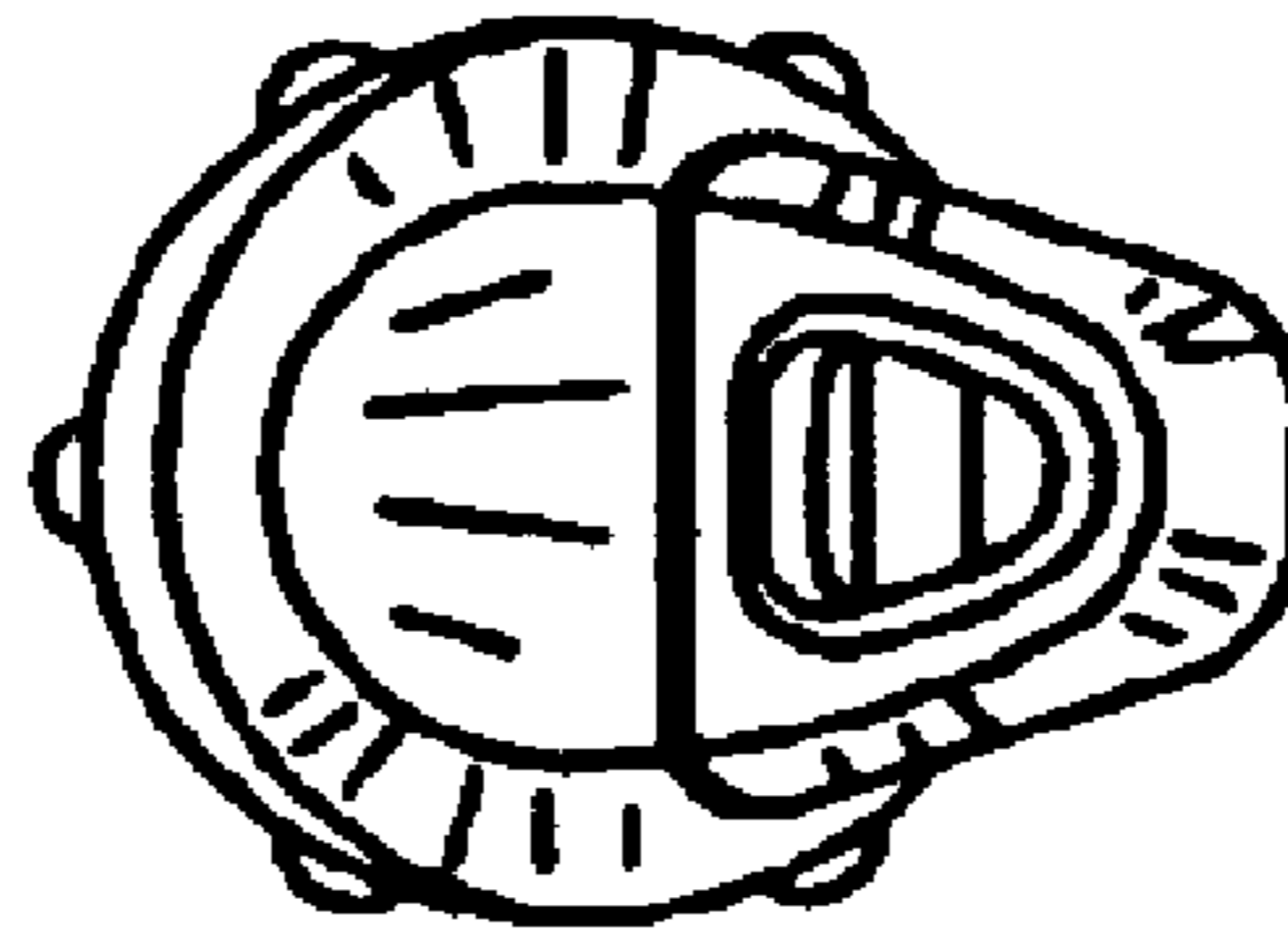

FIG. 6

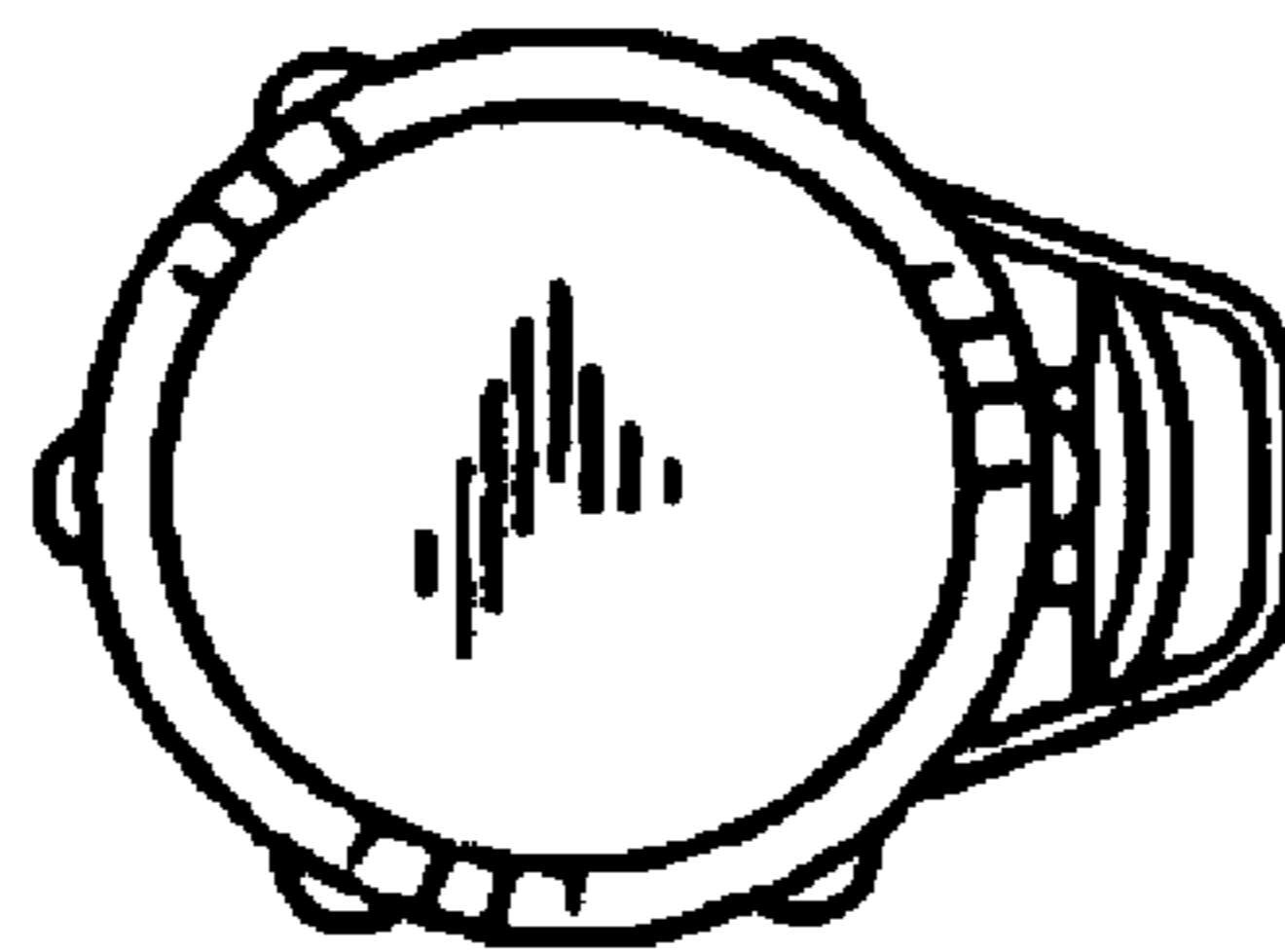

FIG. 7

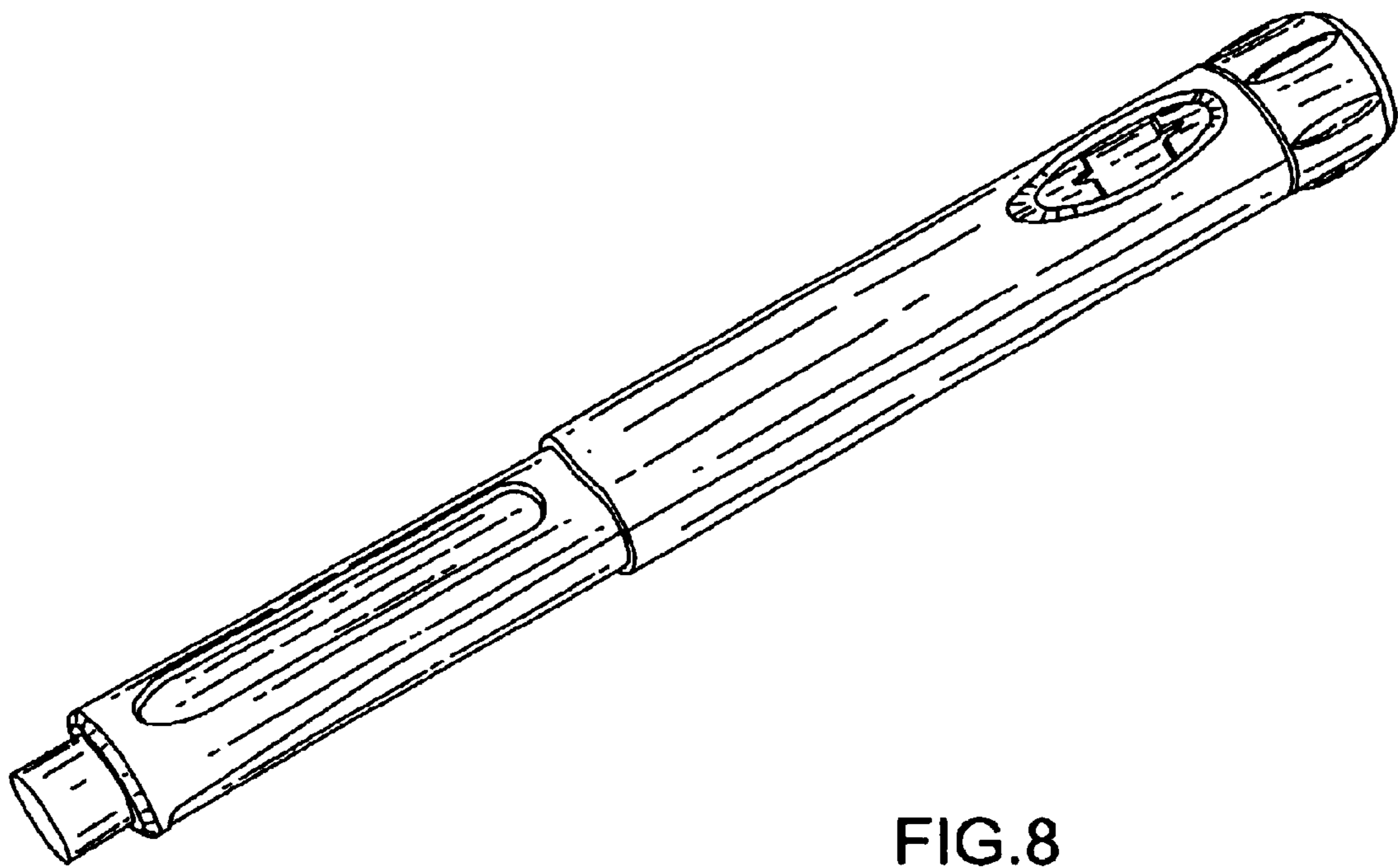

FIG.8

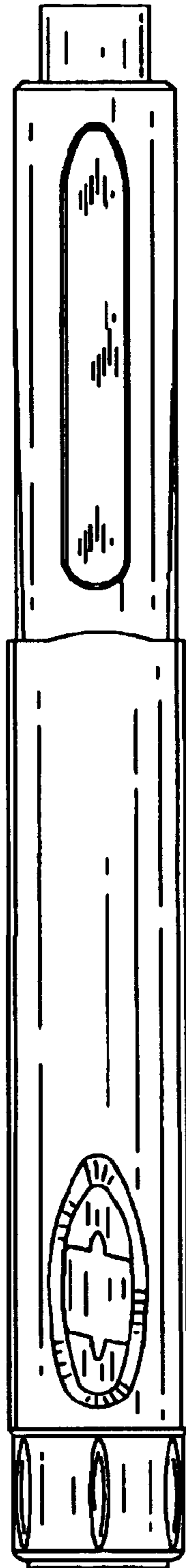

FIG. 9

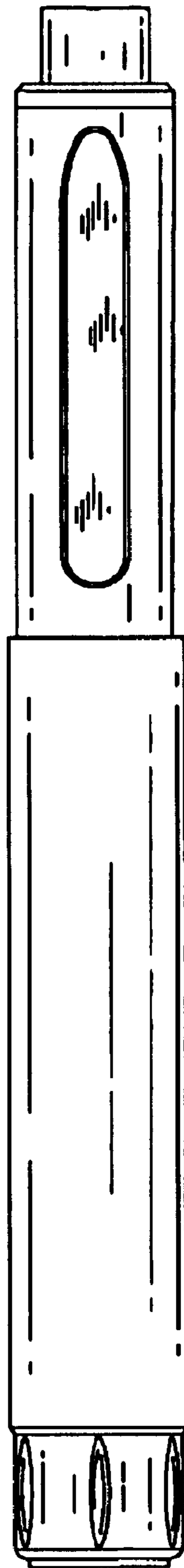

FIG.10

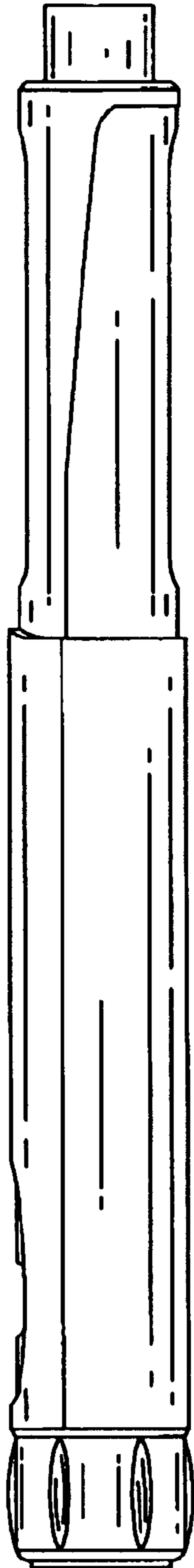

FIG. 11

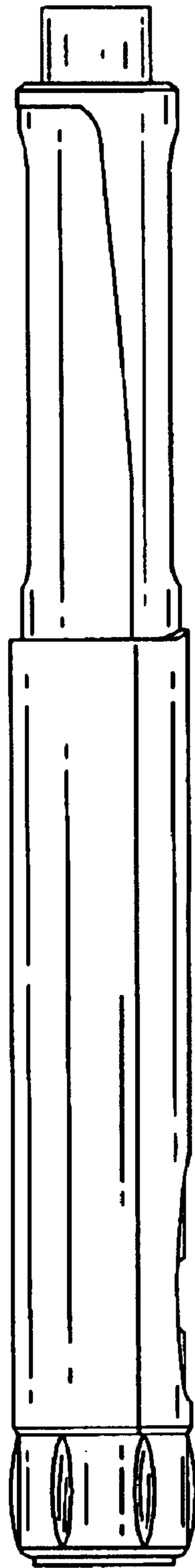

FIG.12

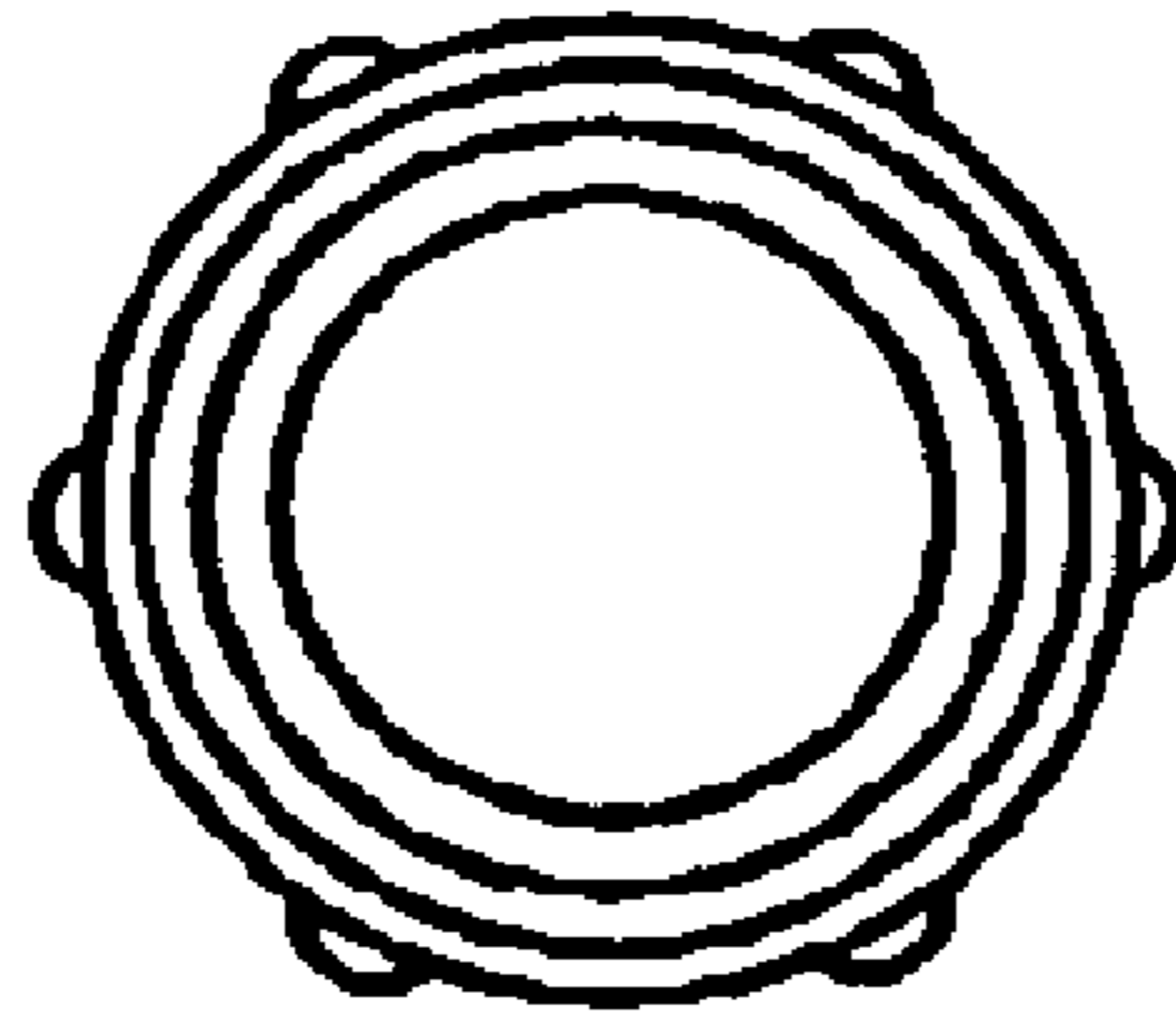

FIG. 13

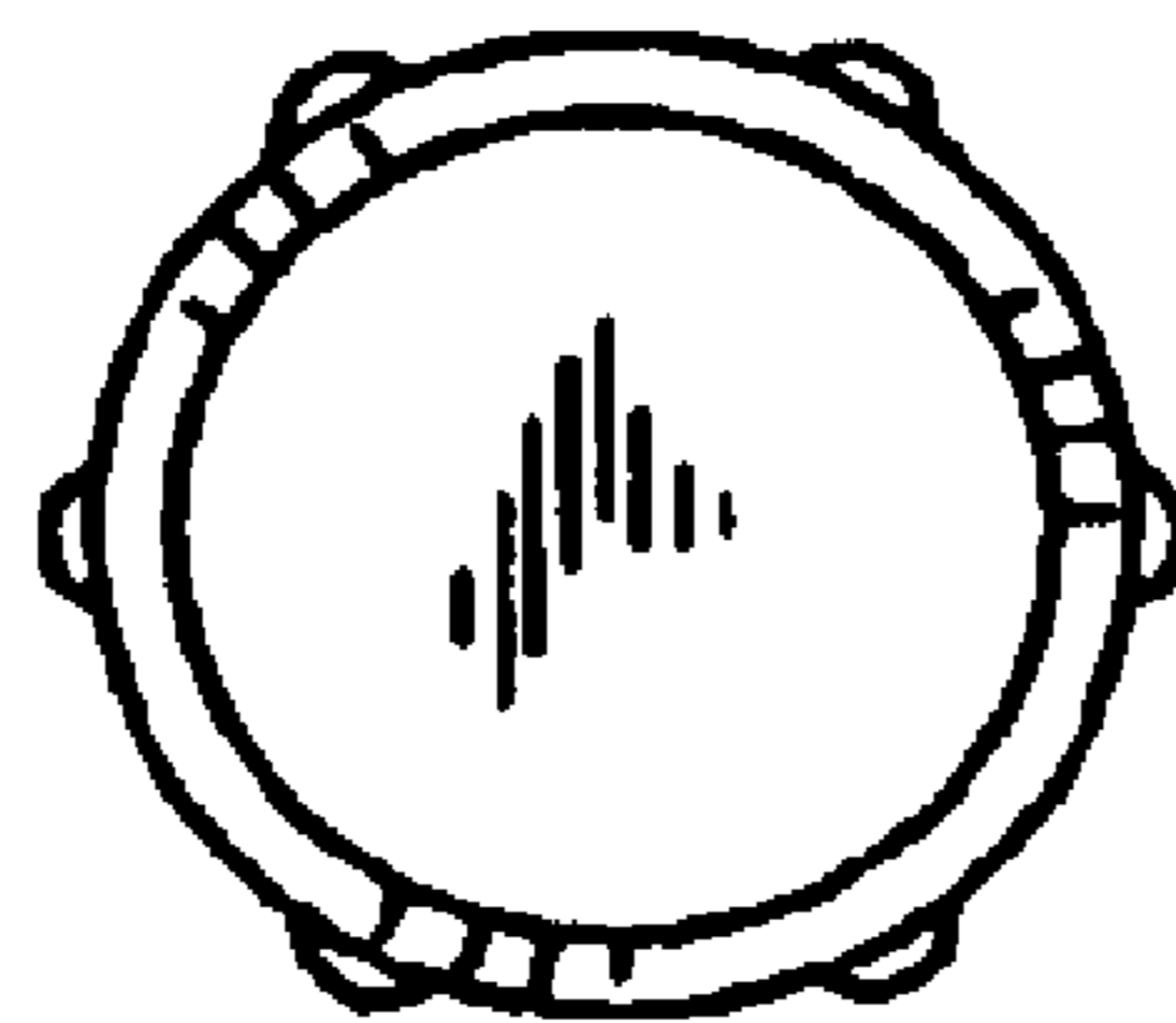

FIG. 14