

US00D492383S1

(12) **United States Design Patent**
Saraya

(10) **Patent No.:** **US D492,383 S**
(45) **Date of Patent:** **** Jun. 29, 2004**

(54) **REEL SEAT FOR FISHING ROD**

FOREIGN PATENT DOCUMENTS

(75) Inventor: **Kenji Saraya**, Higashikurume (JP)

JP 965398 10/1996
JP 1119417 8/2001

(73) Assignee: **Daiwa Seiko, Inc.**, Tokyo (JP)

* cited by examiner

(**) Term: **14 Years**

Primary Examiner—Catherine R. Oliver

(21) Appl. No.: **29/186,017**

(74) *Attorney, Agent, or Firm*—Sughrue Mion, PLLC

(22) Filed: **Jul. 9, 2003**

(57) **CLAIM**

(30) **Foreign Application Priority Data**

The ornamental design for a reel seat for fishing rod, as shown and described.

Jan. 10, 2003 (JP) 2003-000485

DESCRIPTION

(51) **LOC (7) Cl.** **22-05**

(52) **U.S. Cl.** **D22/142**

(58) **Field of Search** D22/142, 137-140;
43/20, 22, 18.1, 23

FIG. 1 is a perspective view of the top, front and left end of a reel seat for fishing rod showing my new design;

FIG. 2 is a perspective view of the bottom, rear and right end view thereof;

FIG. 3 is a front elevational view thereof;

FIG. 4 is a rear elevational view thereof;

FIG. 5 is a top plan view thereof;

FIG. 6 is a bottom plan view thereof;

FIG. 7 is a left end elevational view thereof;

FIG. 8 is a right end elevational view thereof;

FIG. 9 is a sectional view taken on line 9-9 in FIG. 3; and,

FIG. 10 is a sectional view taken on line 10-10 in FIG. 7.

The broken line showing of environment in the drawings is for illustrative purposes only and forms no part of the claimed design.

(56) **References Cited**

U.S. PATENT DOCUMENTS

D316,738 S	5/1991	Oyama	D22/142
D329,909 S	9/1992	Oyama	D22/142
D381,736 S	* 7/1997	Grice	D22/142
D382,934 S	* 8/1997	Grice	D22/142
D391,621 S	3/1998	Oyama et al.	D22/142
D393,043 S	* 3/1998	Grice	D22/142
D403,044 S	12/1998	Tayama et al.	D22/142
D418,194 S	* 12/1999	Oyama et al.	D22/142
D425,170 S	5/2000	Ohmura	D22/142
D460,517 S	* 7/2002	Lu	D22/142

1 Claim, 3 Drawing Sheets

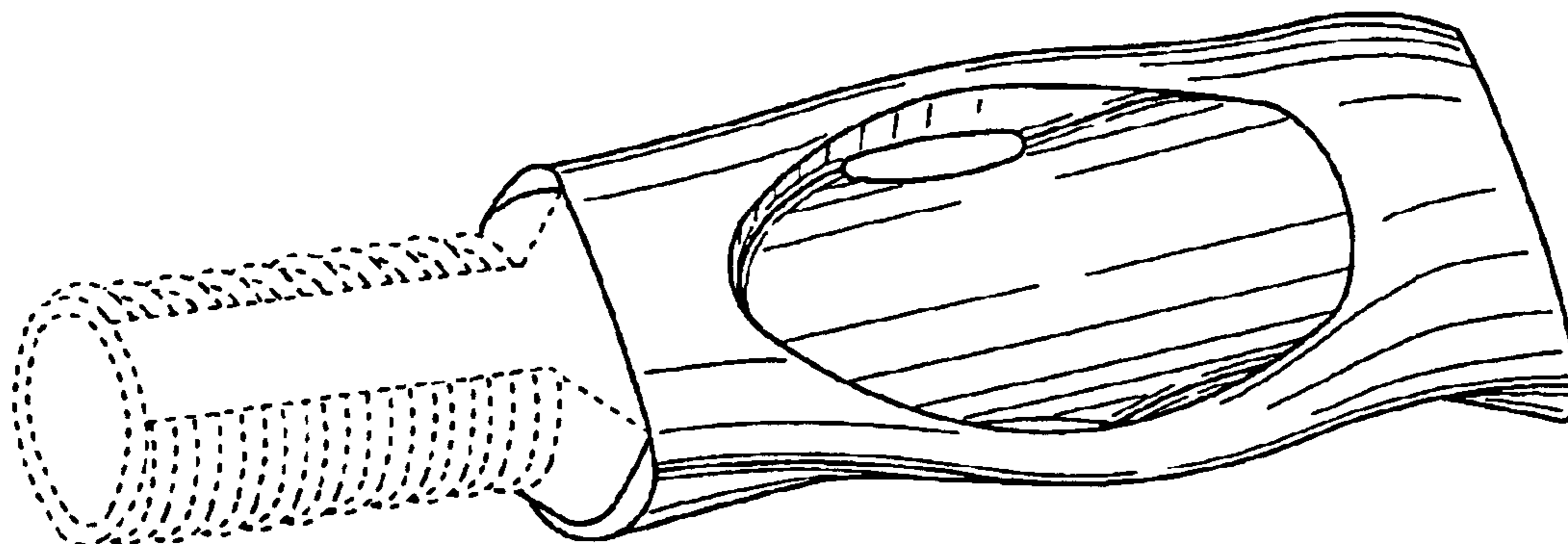

FIG. 1

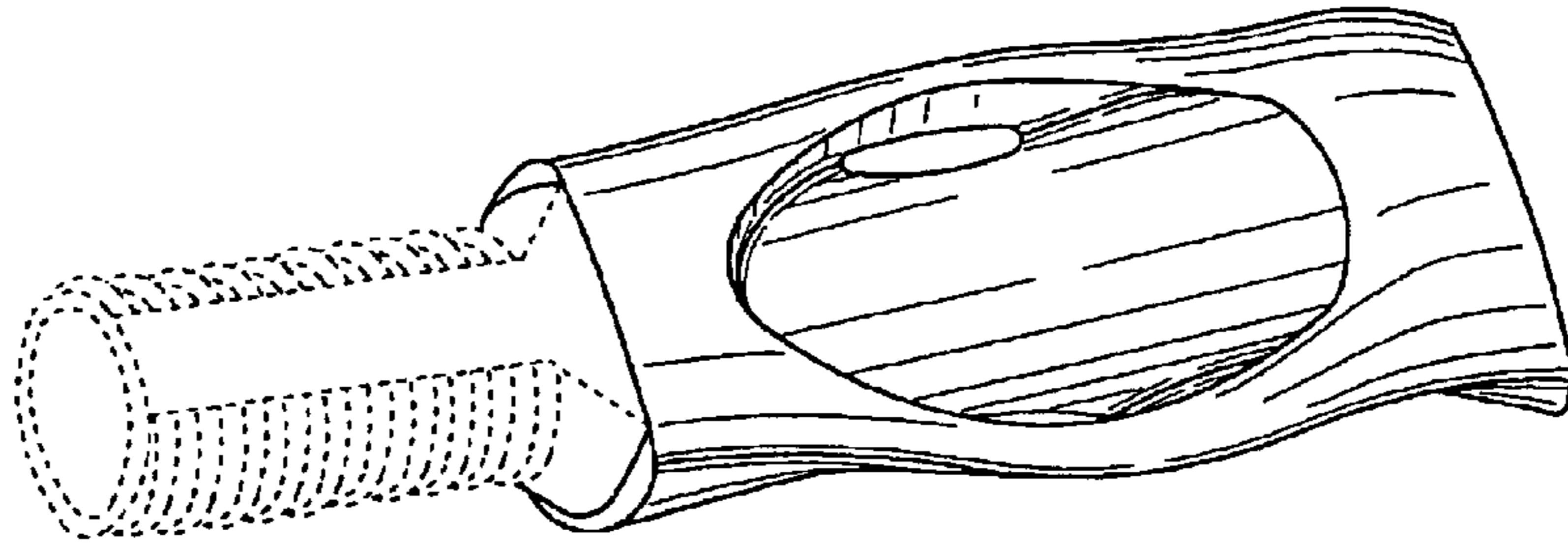

FIG. 2

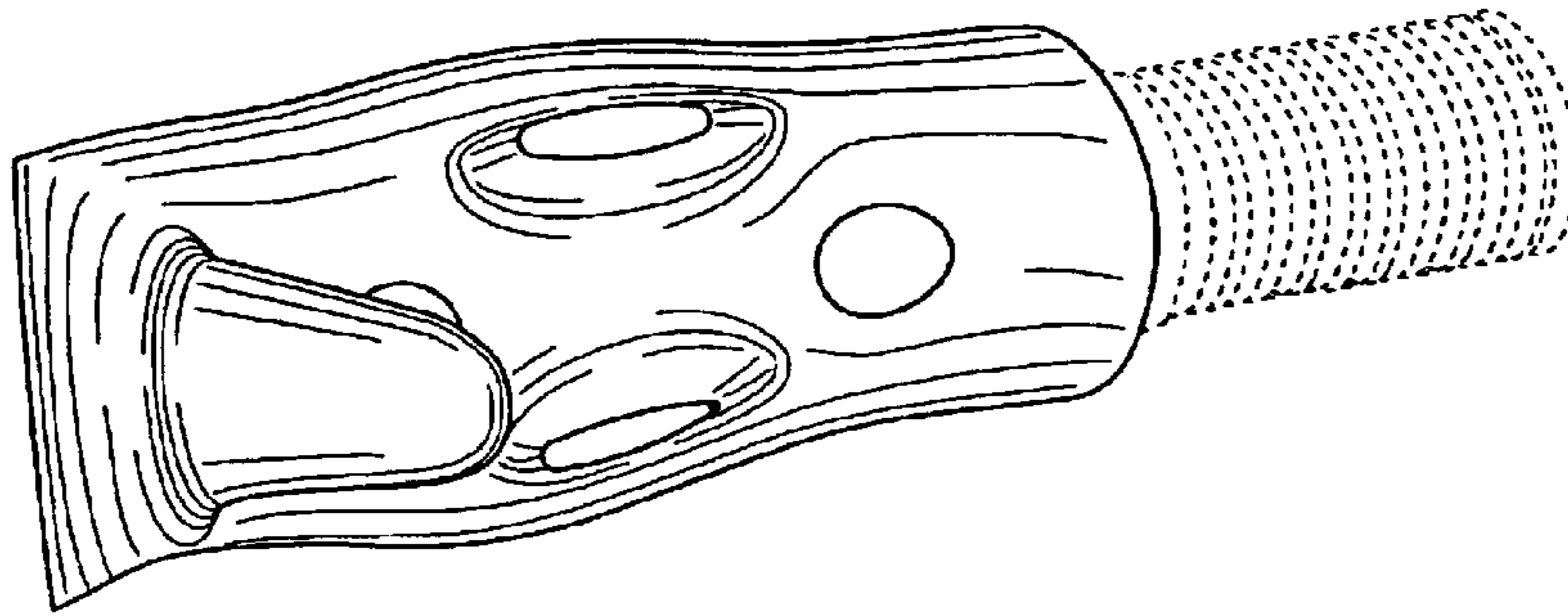

FIG. 3

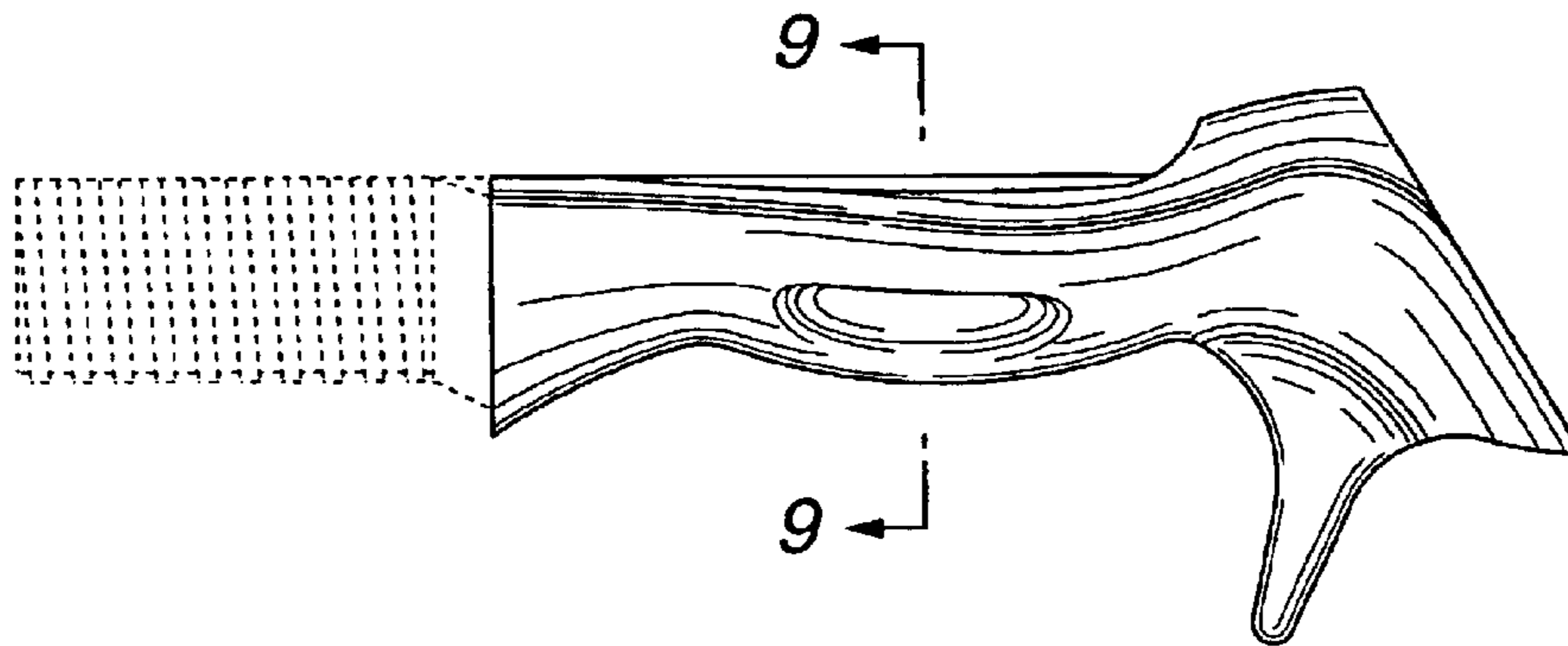

FIG. 4

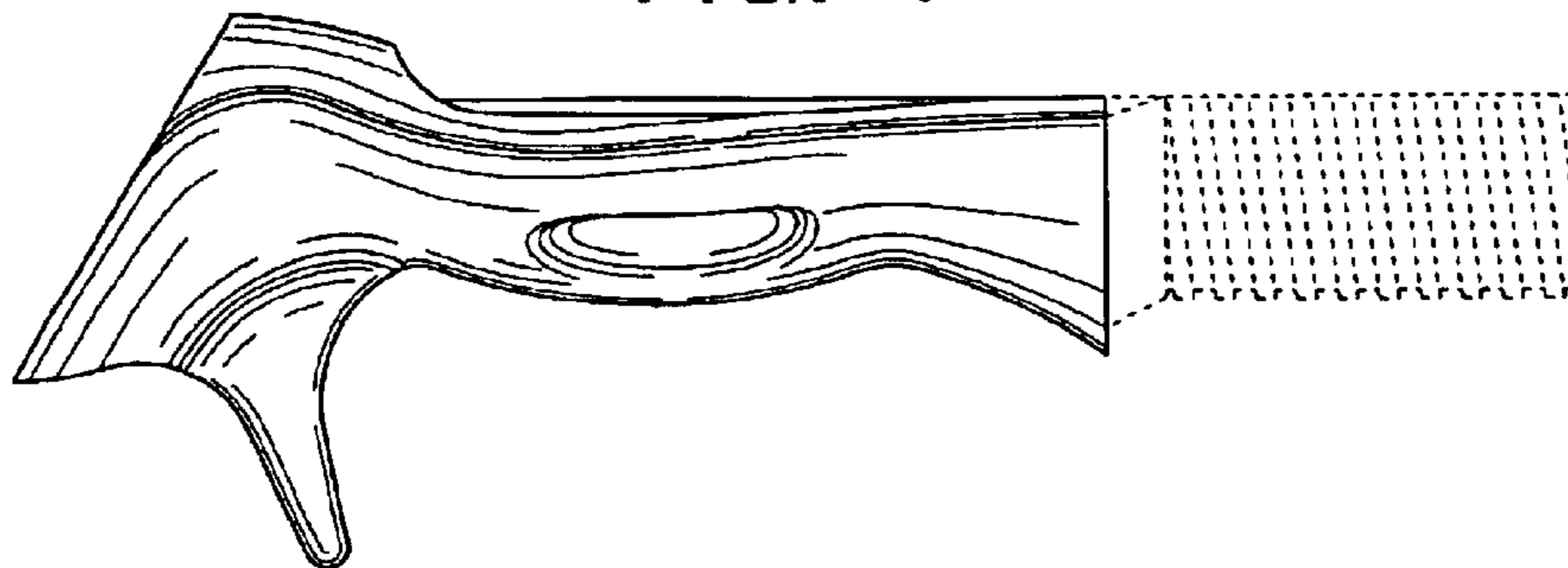

FIG. 5

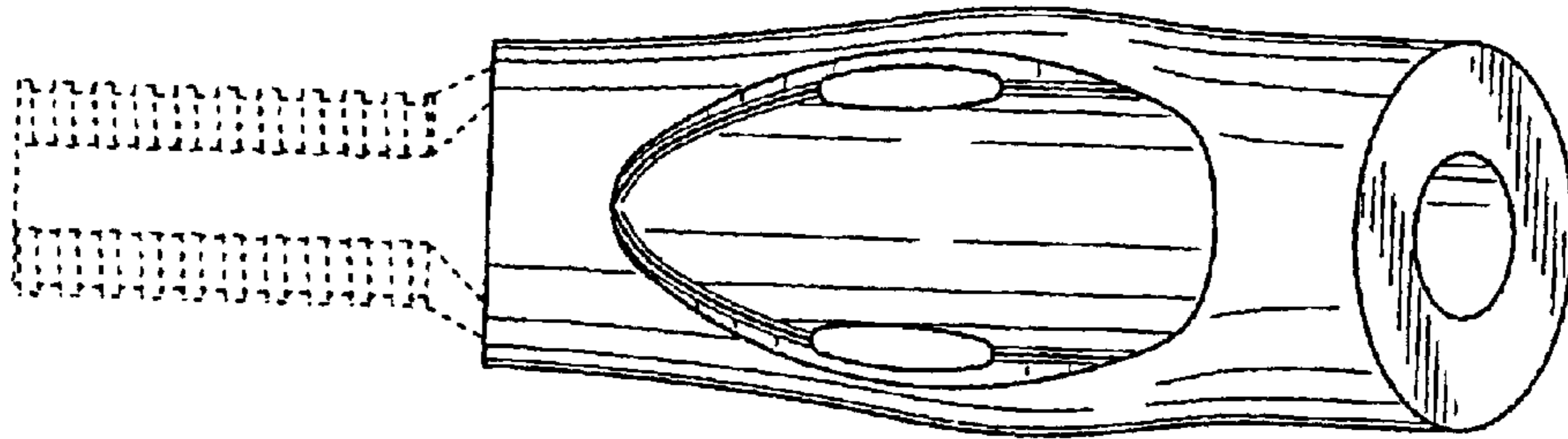

FIG. 6

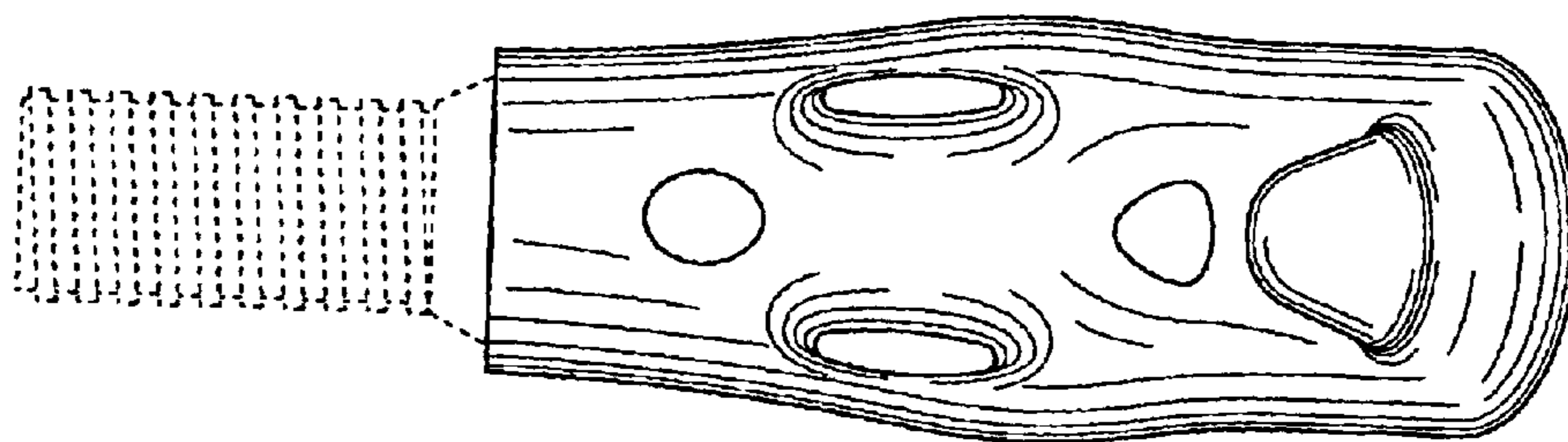

FIG. 7

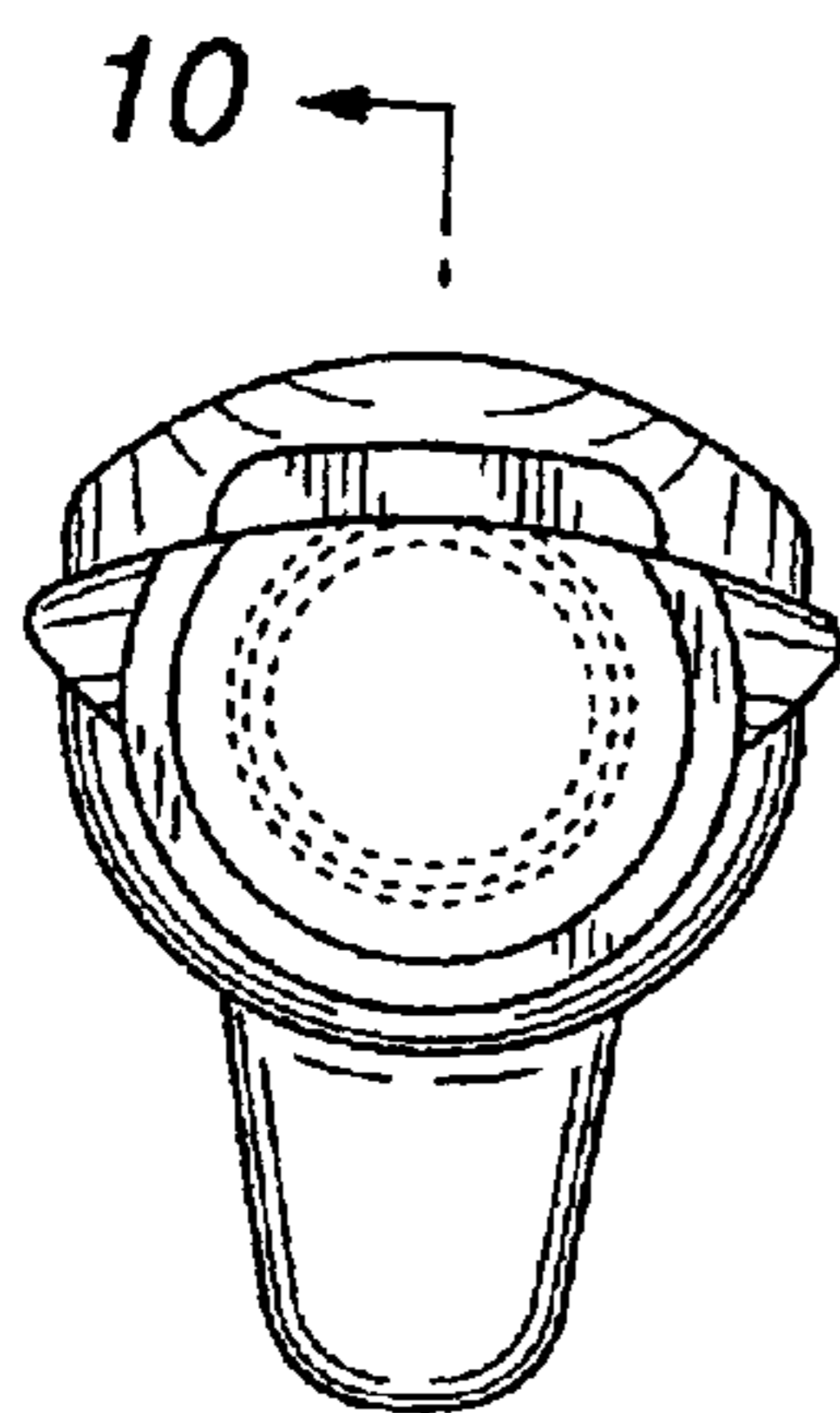
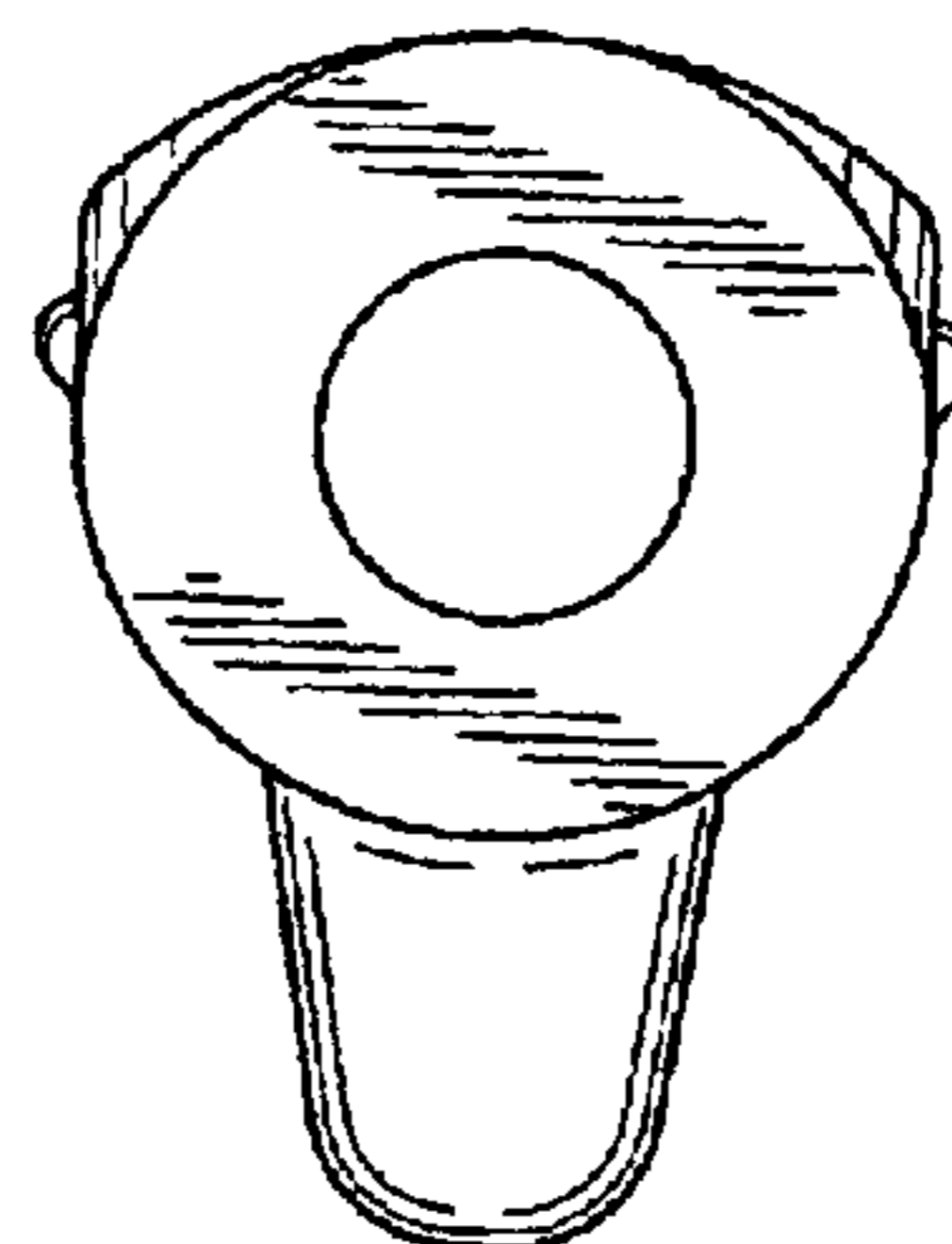

FIG. 8



10

FIG. 9

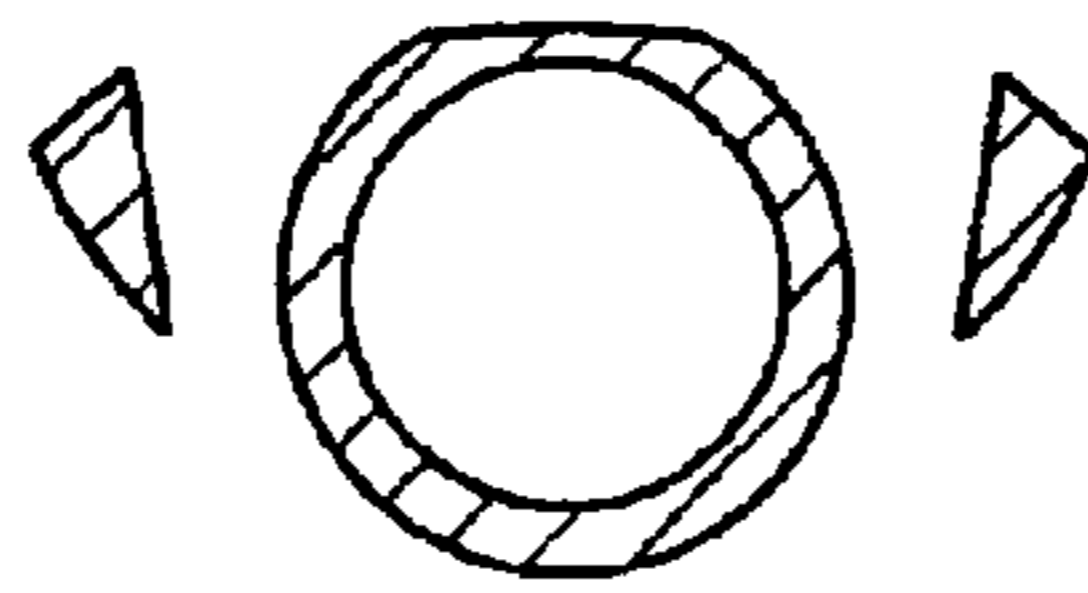

FIG. 10

