

US00D492268S1

(12) **United States Design Patent**
Mathews Reynolds et al.

(10) **Patent No.: US D492,268 S**
(45) **Date of Patent: ** Jun. 29, 2004**

(54) **FRONT BEZEL FOR CONSUMER ELECTRONIC PRODUCT**

D443,254 S * 6/2001 Jensen et al. D14/125
D469,066 S * 1/2003 Takahashi D14/125

(75) Inventors: **Carol Ann Mathews Reynolds**,
Levittown, PA (US); **Keith E. Sibley**,
Willow Grove, PA (US); **Francis John
Dunn**, Perkasio, PA (US); **Timothy
Kenneth Newman**, Harleysville, PA
(US); **Paul Ocepek**, Norfolk, MA (US);
William J. Storti, Haverford, PA (US)

* cited by examiner

Primary Examiner—Raphael Barkai
(74) *Attorney, Agent, or Firm*—Volpe and Koenig, P.C.

(73) Assignee: **General Instrument Corporation**,
Horsham, PA (US)

(57) **CLAIM**

The ornamental design for a front bezel for consumer electronic product, as shown and described.

(**) Term: **14 Years**

DESCRIPTION

(21) Appl. No.: **29/179,236**

FIG. 1 is a perspective view, from the front and above, of a front bezel for a consumer electronic product showing our new design;

(22) Filed: **Apr. 7, 2003**

FIG. 2 is a front view thereof;

Related U.S. Application Data

FIG. 3 is a top view thereof;

(63) Continuation of application No. 29/166,917, filed on Sep. 5, 2002, now Pat. No. Des. 481,019.

FIG. 4 is a bottom view thereof;

(51) **LOC (7) Cl.** **14-03**

FIG. 5 is a left side view thereof;

(52) **U.S. Cl.** **D14/125**

FIG. 6 is the right side view thereof; and,

(58) **Field of Search** D14/299, 356,
D14/361–363, 365, 496, 125–126, 135–136,
239; 348/10, 460, 706; 361/690–696; 312/208.1,
223.2, 7.1; 455/6.1, 6.2

FIG. 7 is a perspective view, from the front and above, of a second embodiment of our new design which differs from the first embodiment only in that a portion of the second embodiment is stippled to indicate that the stippled portion contrasts with the other portions of the bezel.

(56) **References Cited**

The broken lines shown in FIGS. 1–7 represent environmental subject matter and form no part of the claimed design. The rear view is omitted and forms no part of the claimed design.

U.S. PATENT DOCUMENTS

D418,518 S * 1/2000 Storti et al. D14/257

1 Claim, 5 Drawing Sheets

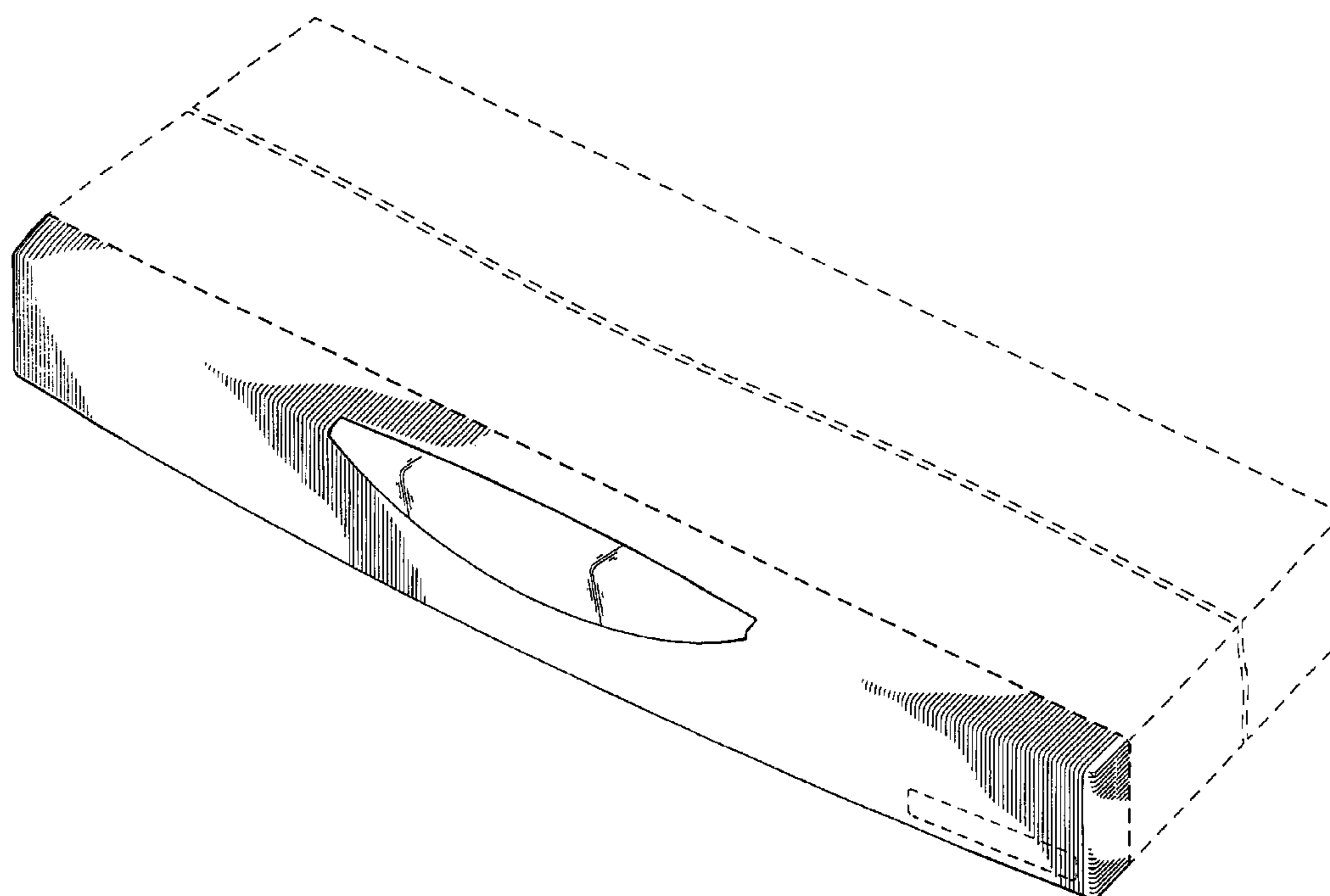

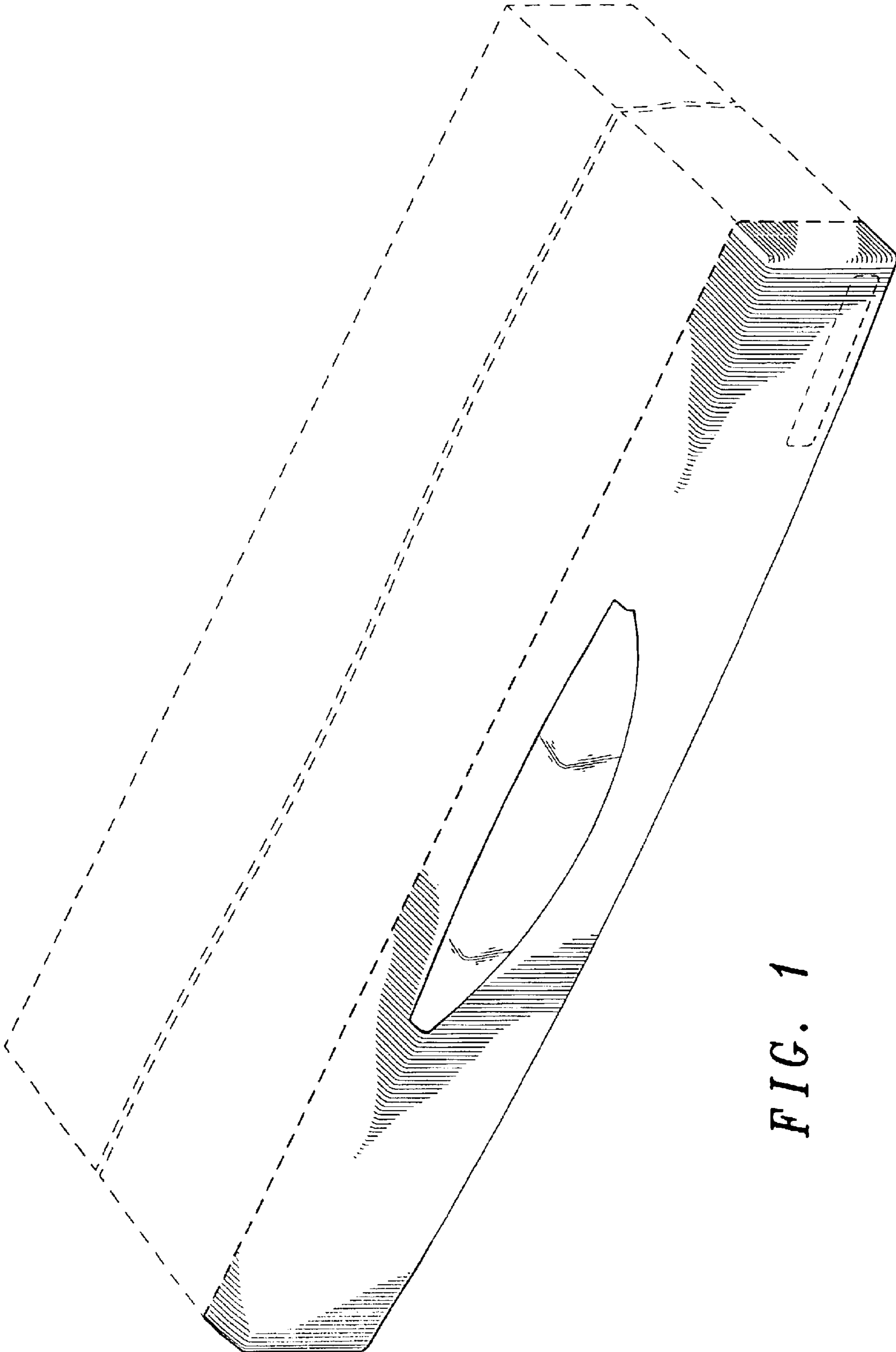

FIG. 1

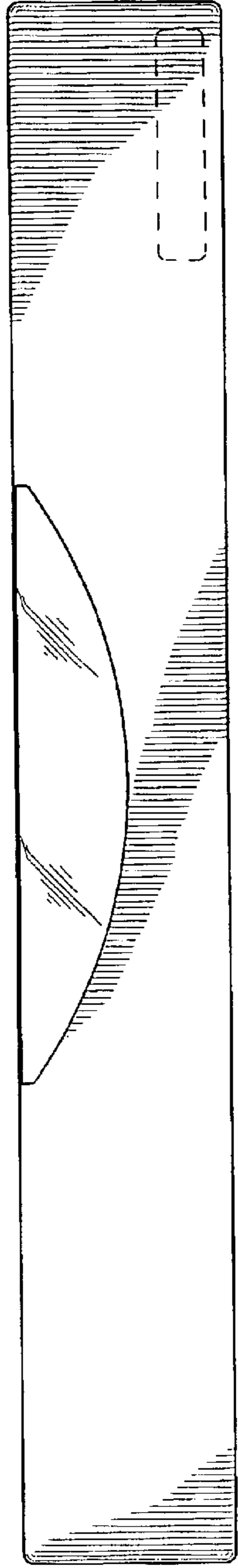
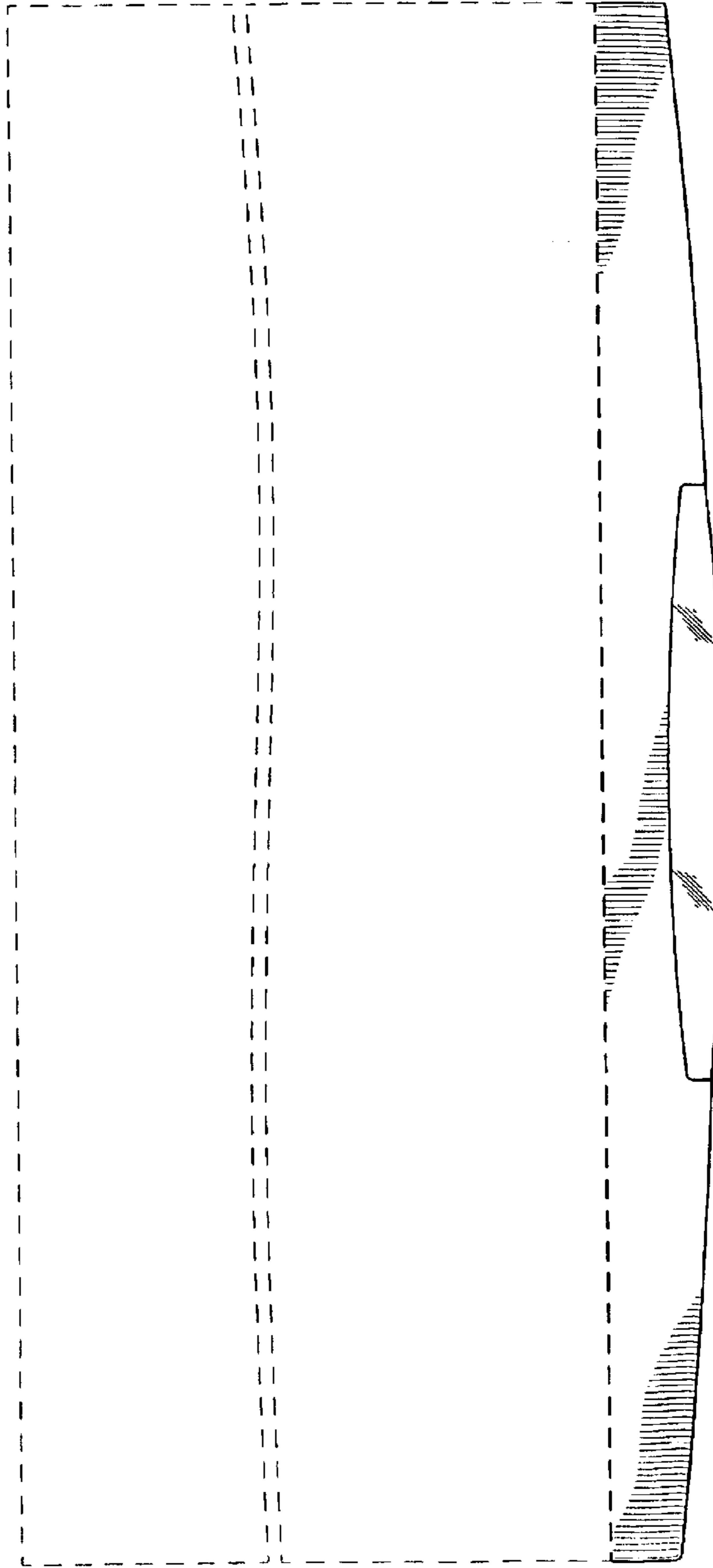

FIG. 2

FIG. 3



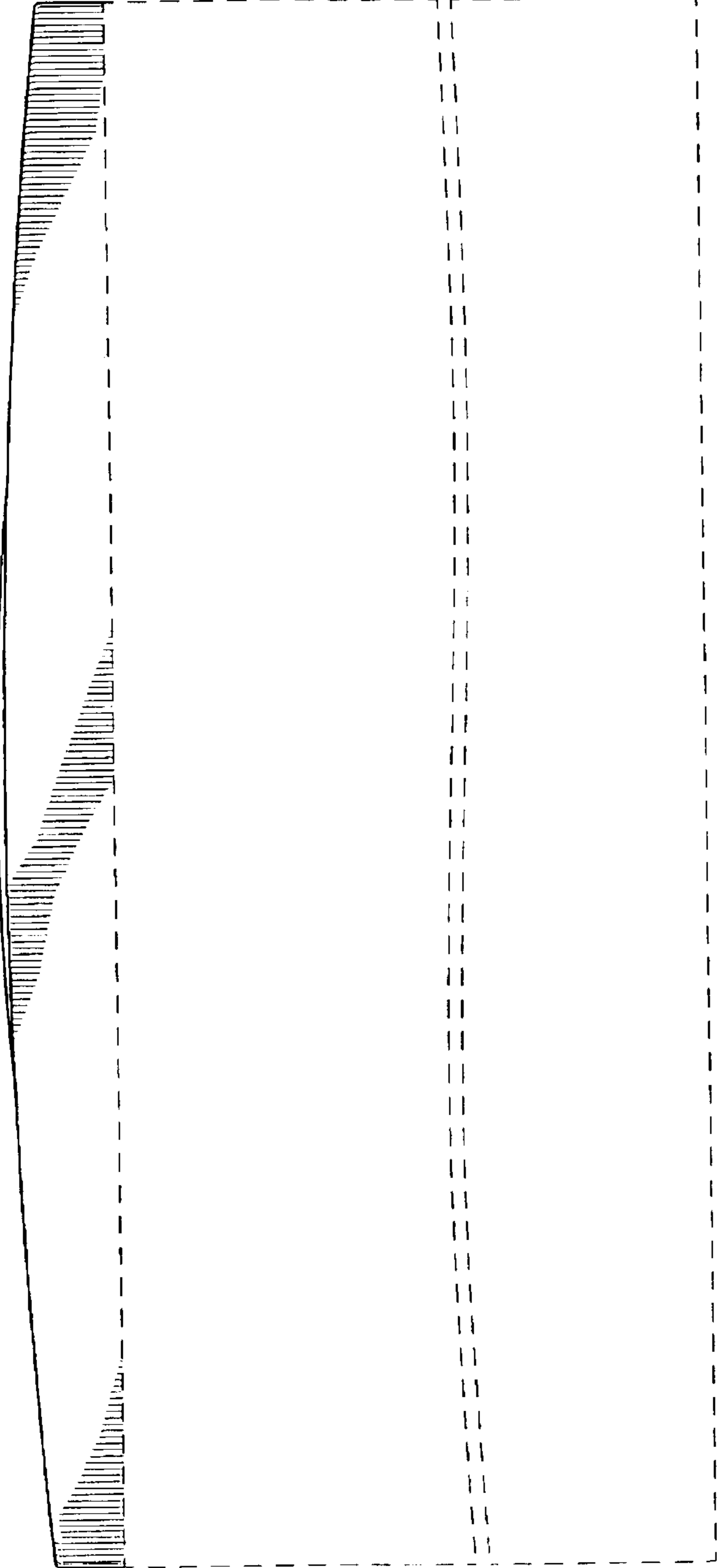

FIG. 4

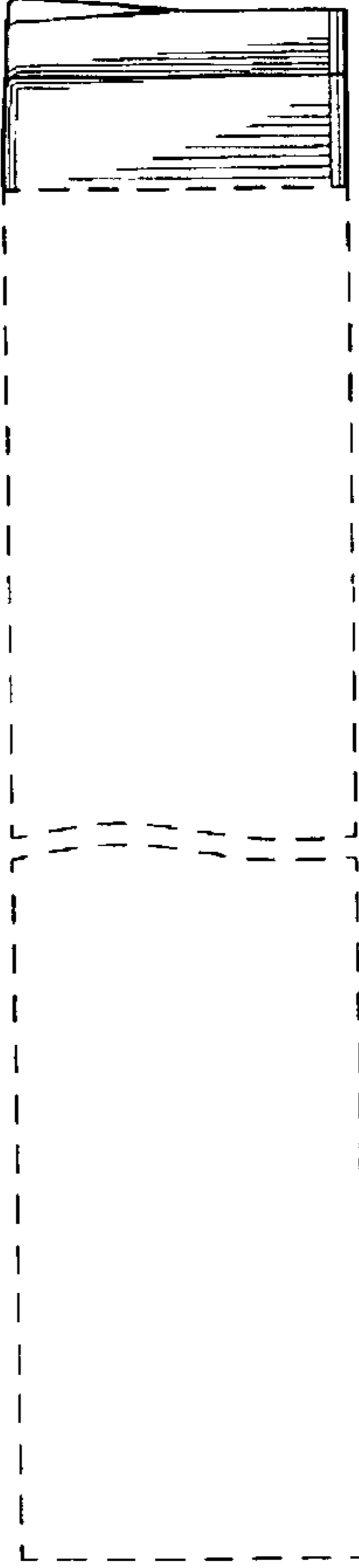

FIG. 5

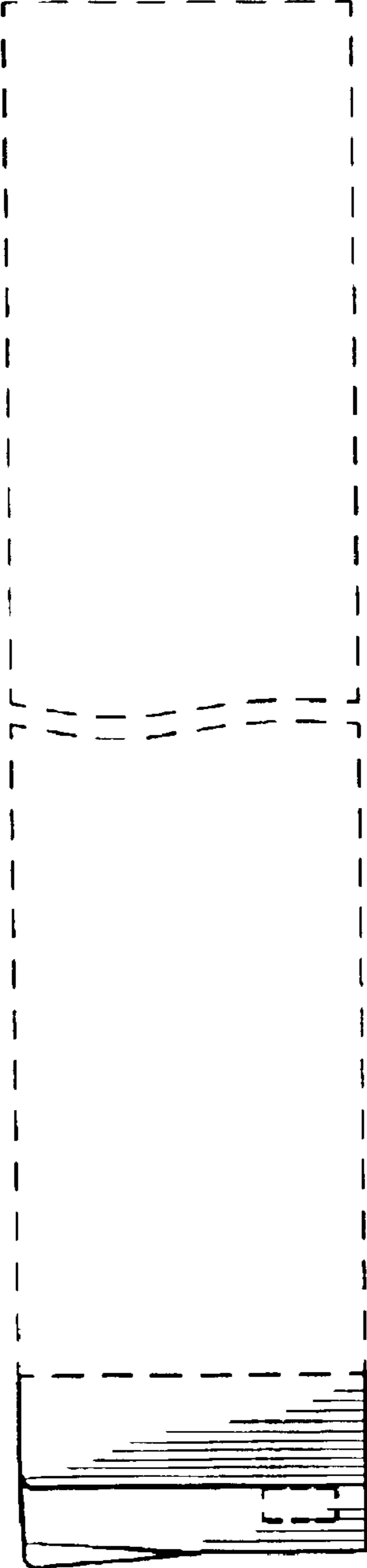

FIG. 6

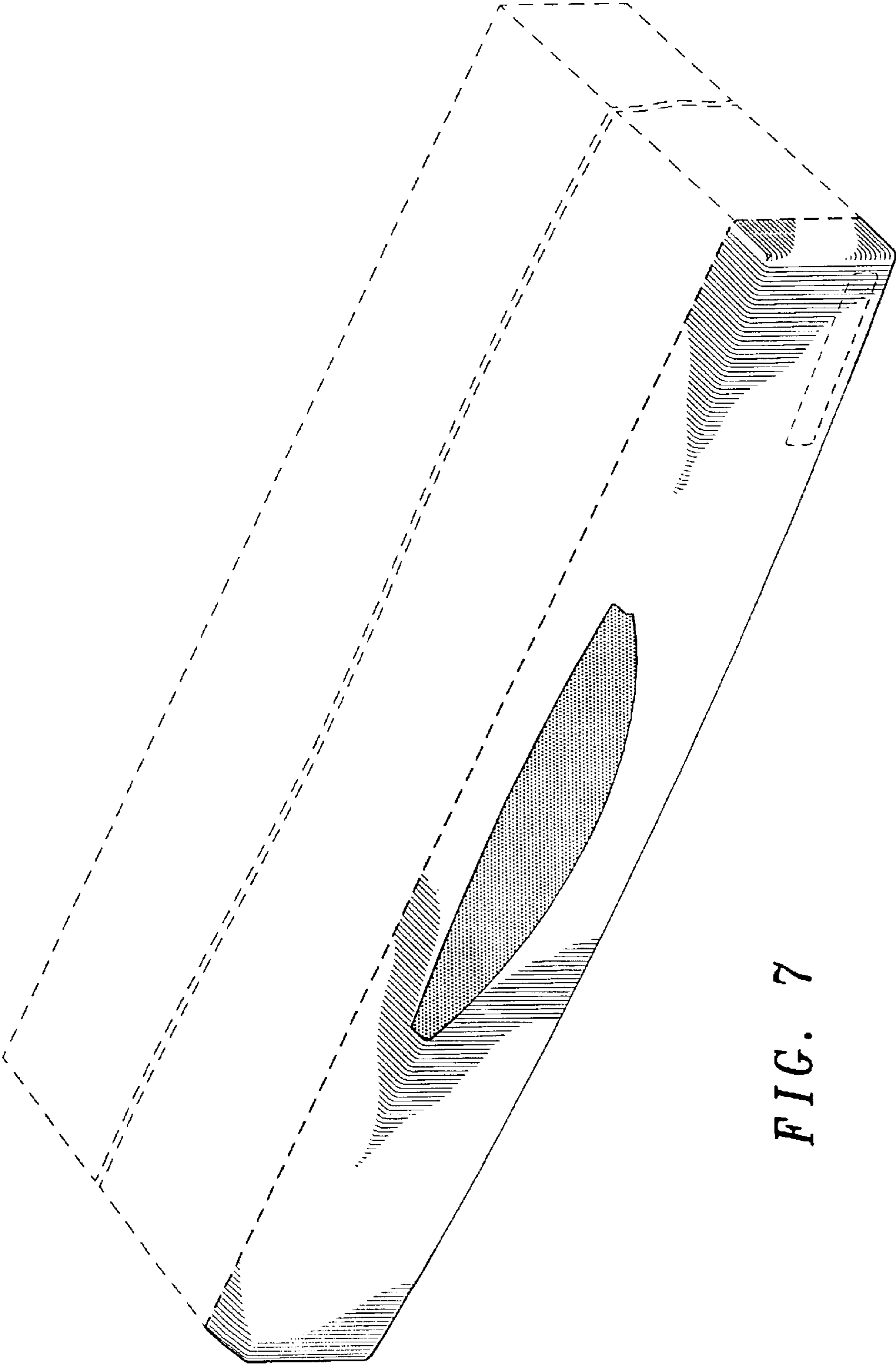

FIG. 7