

US00D492183S1

(12) **United States Design Patent** (10) **Patent No.:** **US D492,183 S**
Becker (45) **Date of Patent:** **** Jun. 29, 2004**

(54) **WALL OR FLOOR MOUNTED LOCKING DEVICE**

(75) Inventor: **Thomas Becker**, Hünfelden (DE)

(73) Assignee: **Abus August Bremicker Sohne KG** (DE)

(**) Term: **14 Years**

(21) Appl. No.: **29/171,437**

(22) Filed: **Nov. 22, 2002**

(51) **LOC (7) Cl.** **08-07**

(52) **U.S. Cl.** **D8/331; D8/336**

(58) **Field of Search** **D8/330, 331, 336, D8/339, 343, 349, 301; 70/14, 58, 62, 77, 141, 164, 202, 203, 205, 431, 466; 42/57, 58, 70, 74, 95, 909, 114**

(56) **References Cited**

U.S. PATENT DOCUMENTS

3,955,842	A	*	5/1976	Edwards	292/307	R
4,840,256	A	*	6/1989	Webb	188/112	R
D303,619	S	*	9/1989	Russell et al.	D8/313	
D402,602	S	*	12/1998	Niswanger	D12/162	
D404,636	S	*	1/1999	Pepper	D8/331	
D413,056	S	*	8/1999	Sokurenko et al.	D8/331	
D425,395	S	*	5/2000	Ji	D8/331	
D454,478	S	*	3/2002	Willems	D8/331	
D457,801	S	*	5/2002	Zamberg	D8/331	
D465,400	S	*	11/2002	Moore et al.	D8/331	

FOREIGN PATENT DOCUMENTS

DE	726759	10/1942
DE	1181 889	3/1961
DE	42 38 181 A1	11/1992
DE	IPC 07	2/2003
NL	9301879	11/1993

OTHER PUBLICATIONS

Kryptonite Action Sports Security Products 2002–2003 Brochure.

* cited by examiner

Primary Examiner—Prabhakar Deshmukh
(74) *Attorney, Agent, or Firm*—Greenberg Traurig LLP; Eugene C. Rzucidlo

(57) **CLAIM**

The ornamental design for a wall or floor mounted locking device, as shown and described.

DESCRIPTION

FIG. 1 is a perspective view of a locking device shown with a hoop in a deployed position of use.

FIG. 2 is a front view of the locking device shown with the hoop in a deployed position of use.

FIG. 3 is a rear view of the locking device shown with the hoop in a deployed position of use.

FIG. 4 is a side view from the right of the locking device shown with the hoop in a deployed position of use.

FIG. 5 is a side view from the left of the locking device shown with the hoop in a deployed position of use.

FIG. 6 is a top view of the locking device shown with the hoop in a deployed position of use.

FIG. 7 is a bottom view of the locking device shown with the hoop in a deployed position of use.

FIG. 8 is a perspective view of a locking device shown with a hoop in a recessed rest position.

FIG. 9 is a front view of the locking device shown with the hoop in a recessed rest position.

FIG. 10 is a rear view of the locking device shown with the hoop in a recessed rest position.

FIG. 11 is a side view from the right of the locking device shown with the hoop in a recessed rest position.

FIG. 12 is a side view from the left of the locking device shown with the hoop in a recessed rest position.

FIG. 13 is a top view of the locking device shown with the hoop in a recessed rest position; and,

FIG. 14 is a bottom view of the locking device shown with the hoop in a recessed rest position.

1 Claim, 8 Drawing Sheets

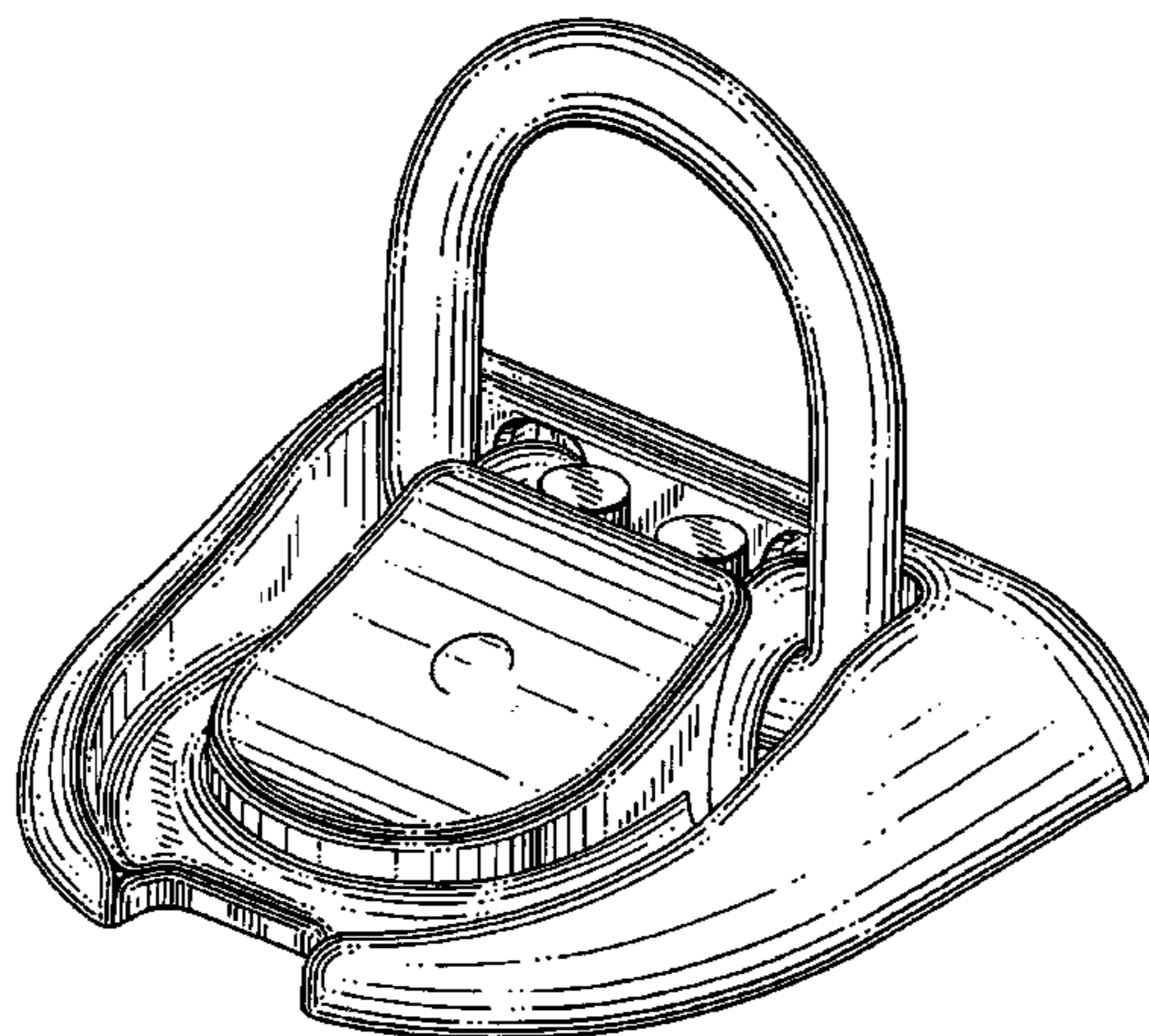

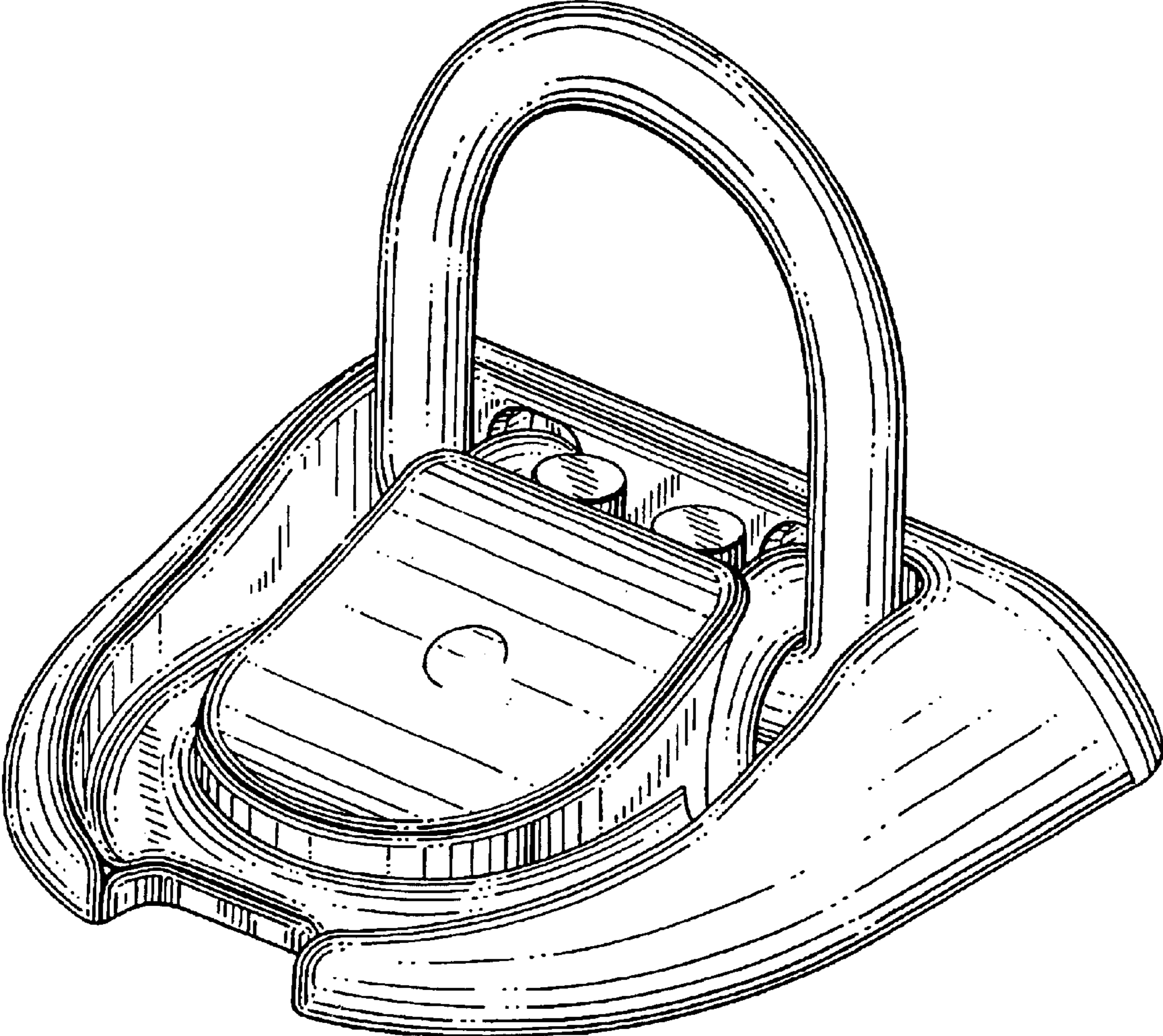

FIG. 1

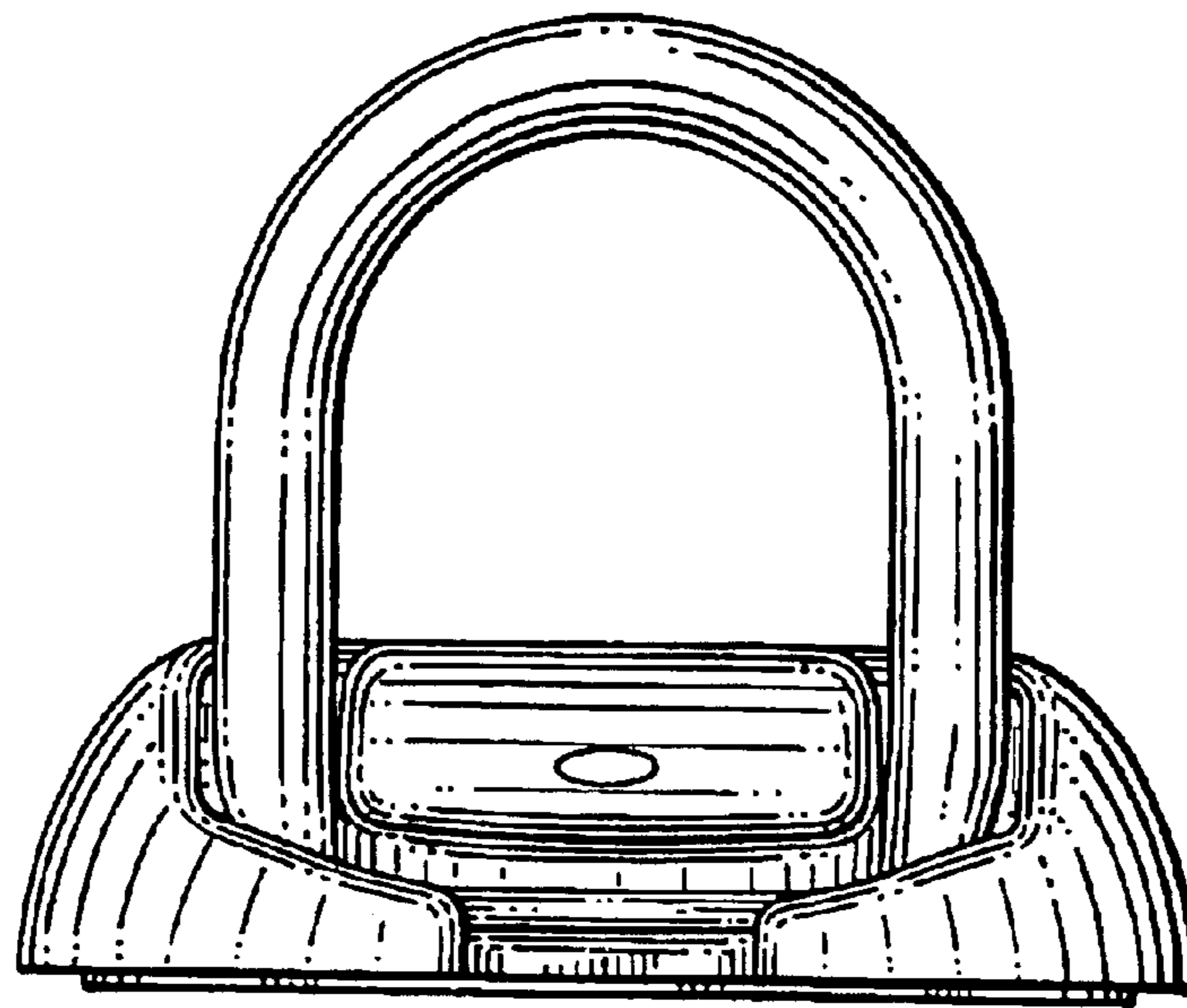

FIG. 2

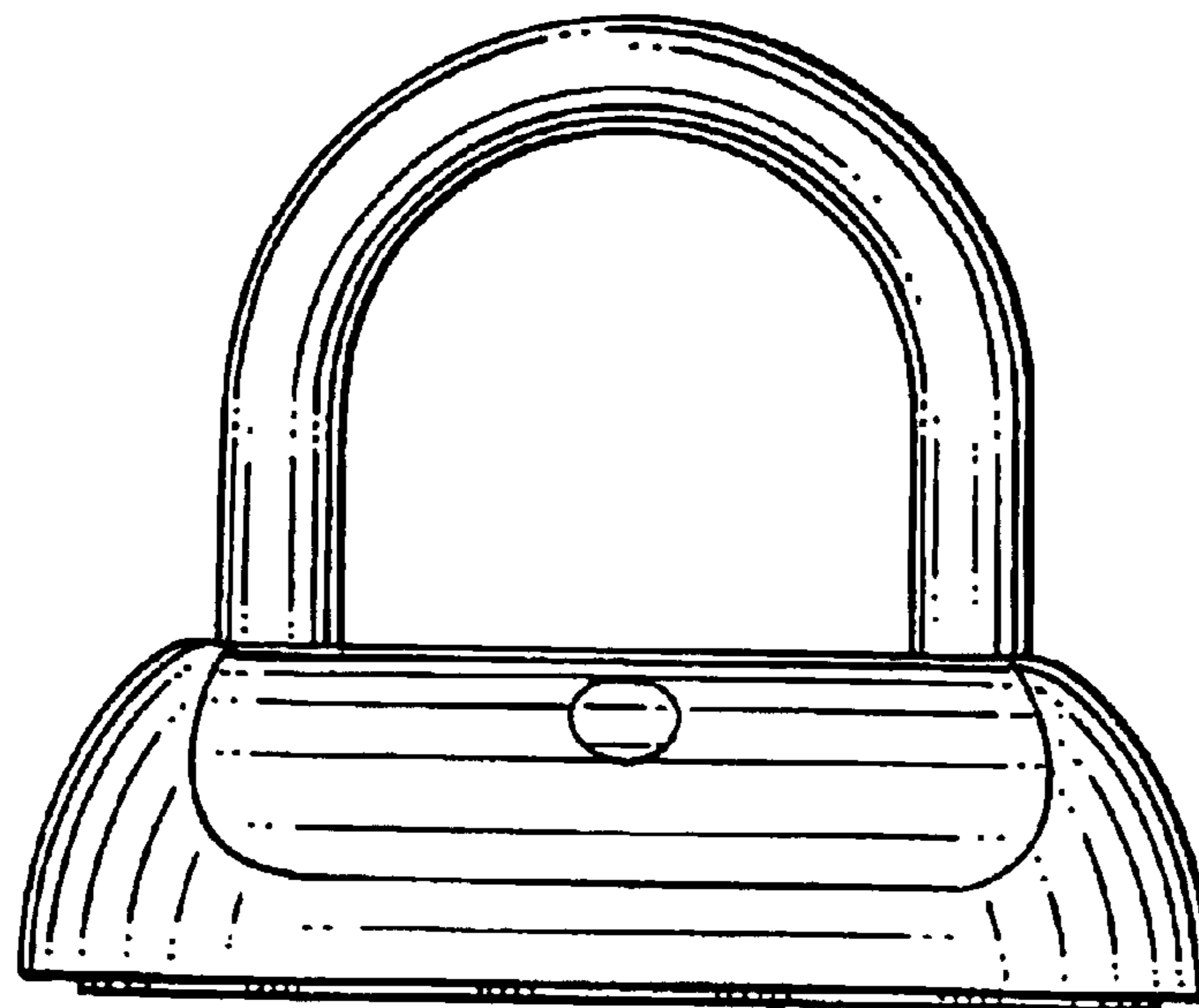

FIG. 3

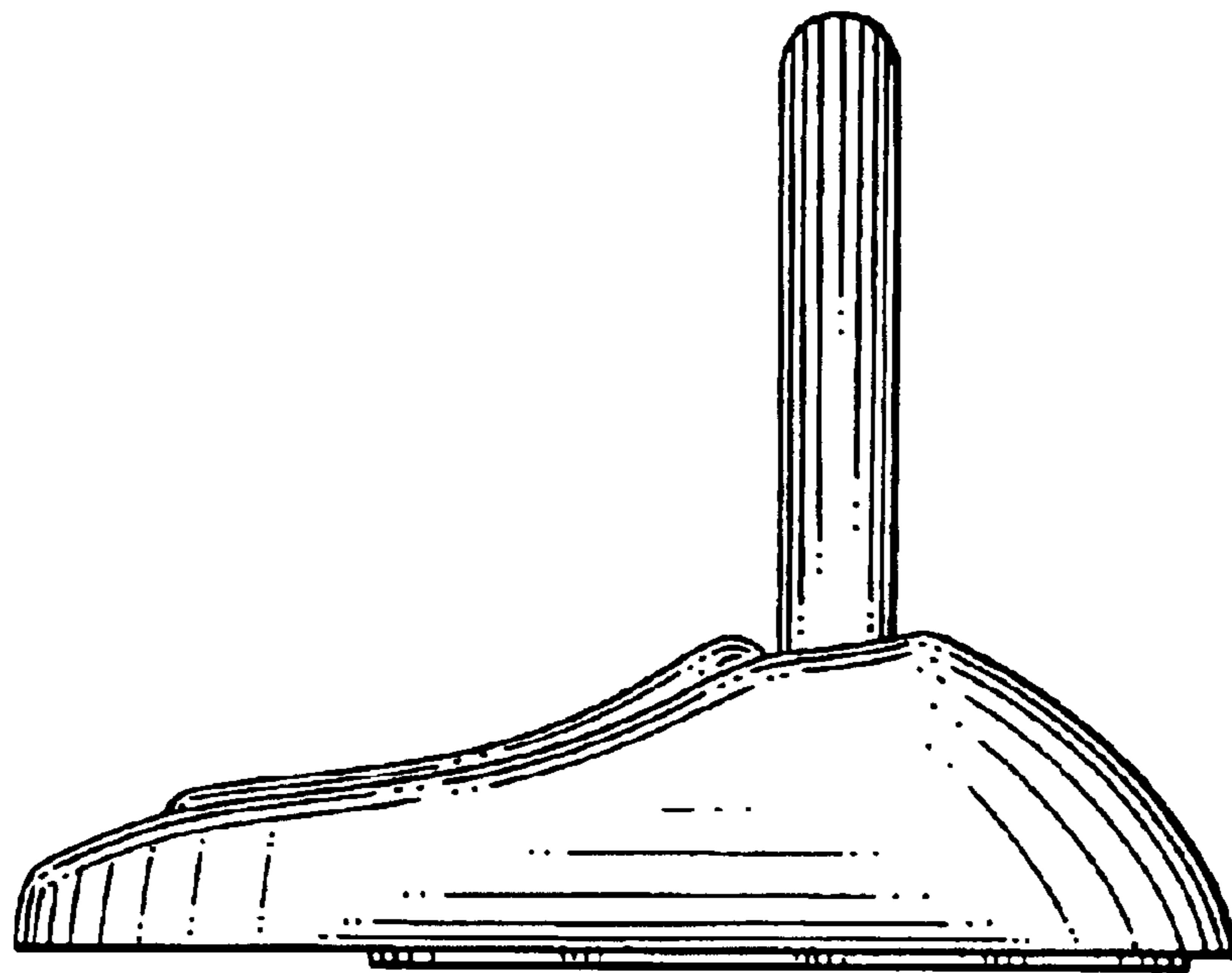

FIG. 4

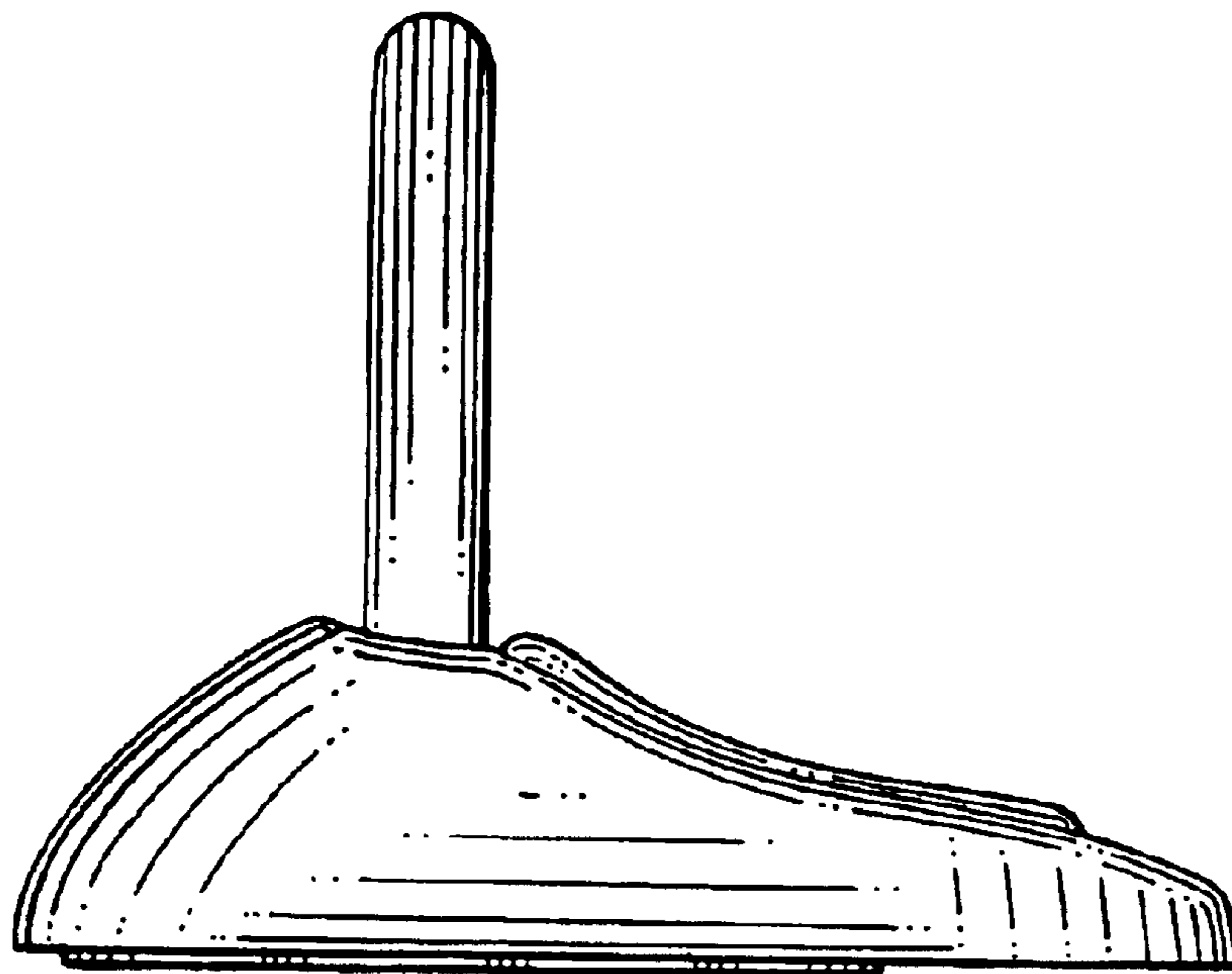

FIG. 5

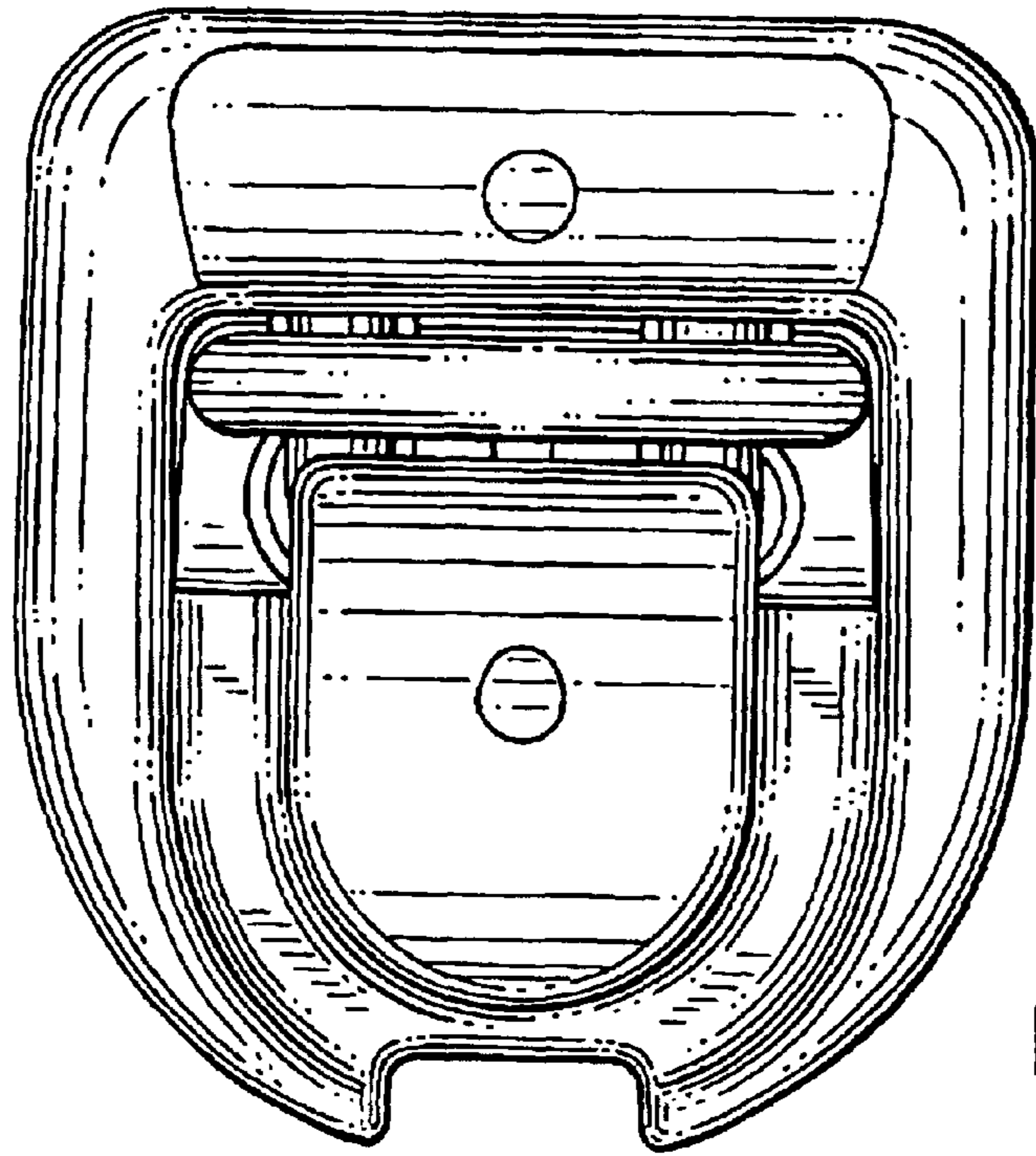

FIG. 6

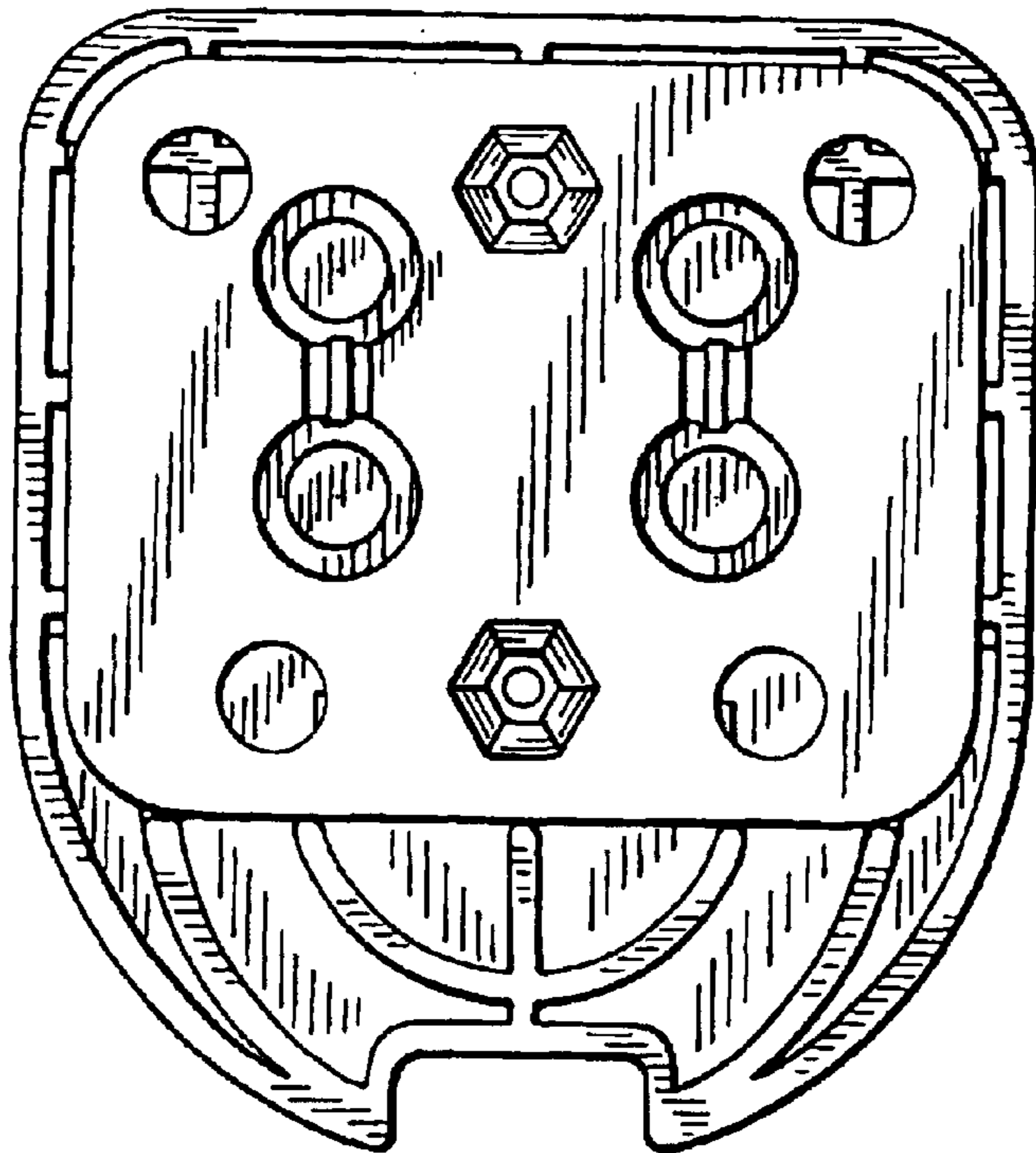

FIG. 7

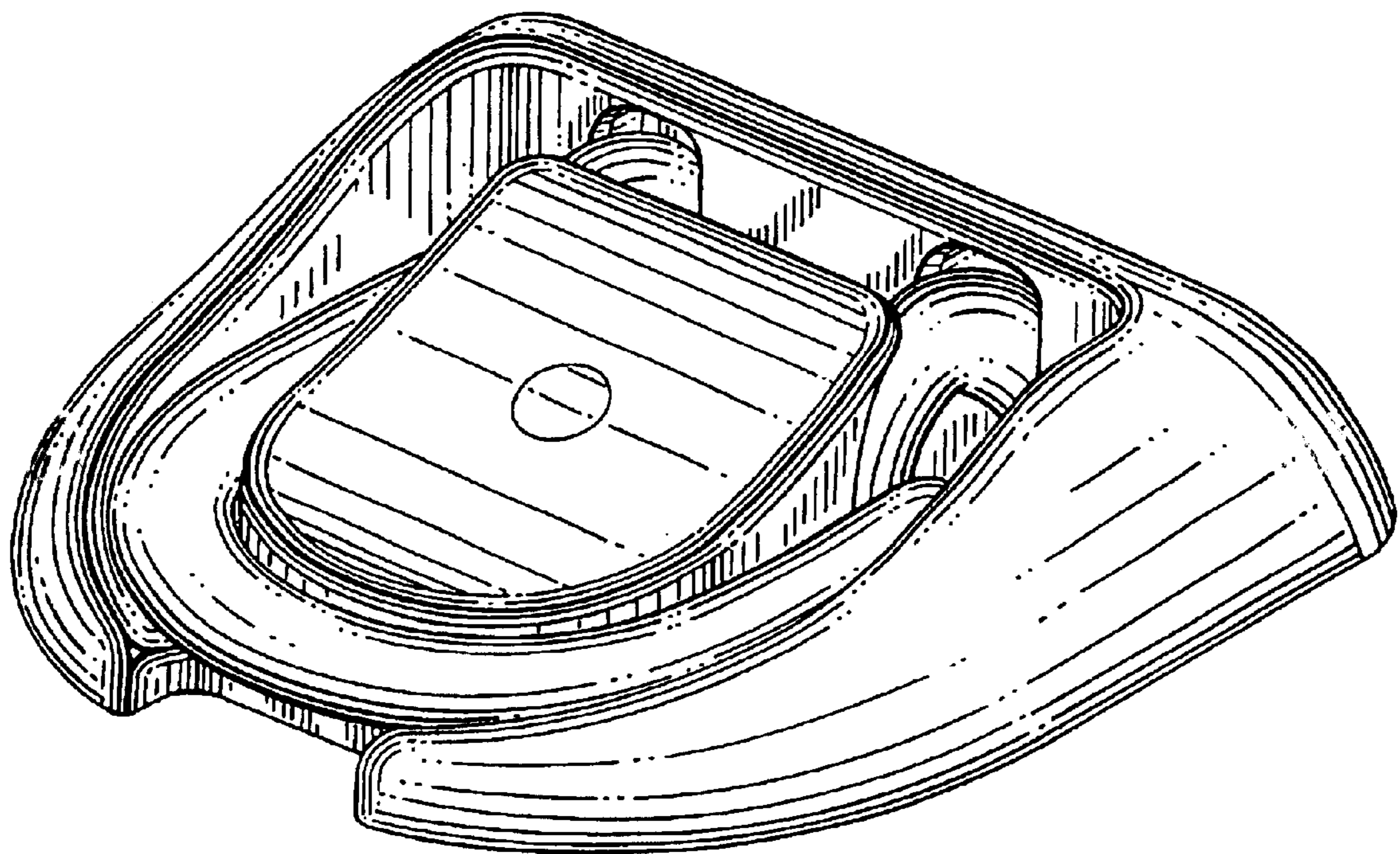

FIG. 8

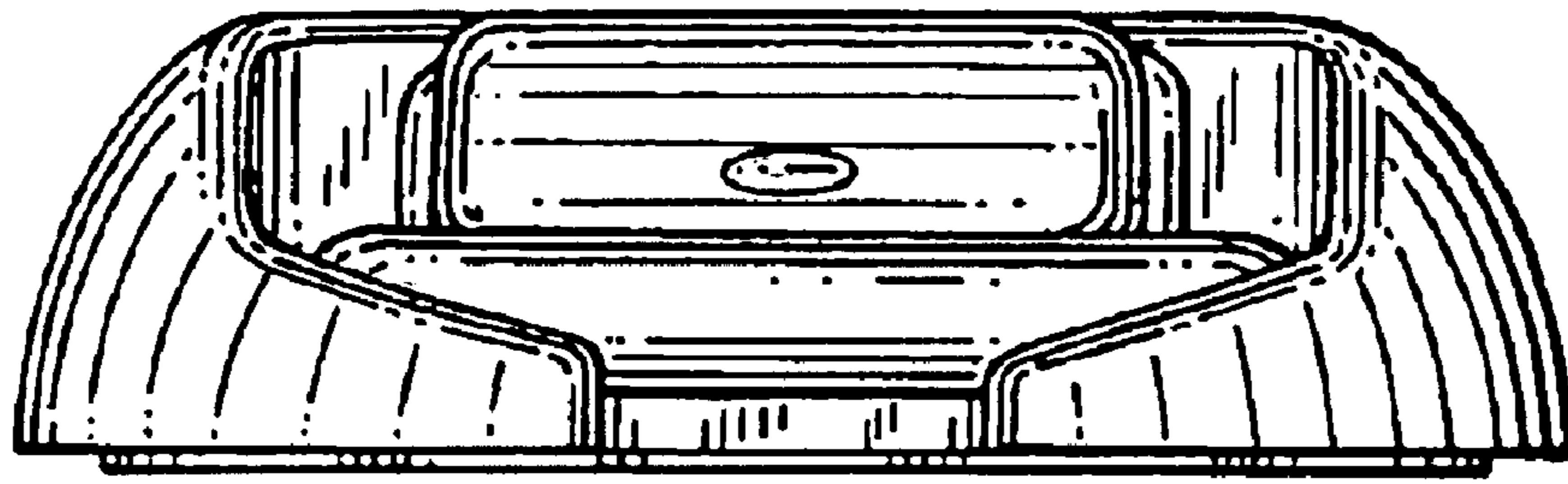

FIG. 9

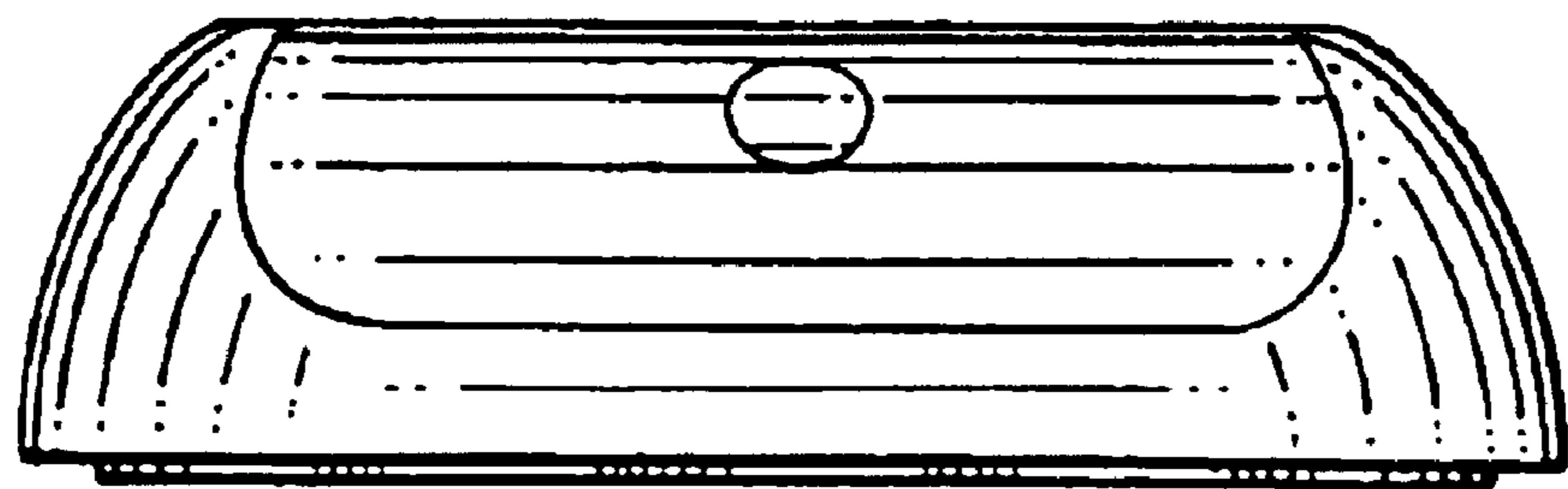

FIG. 10

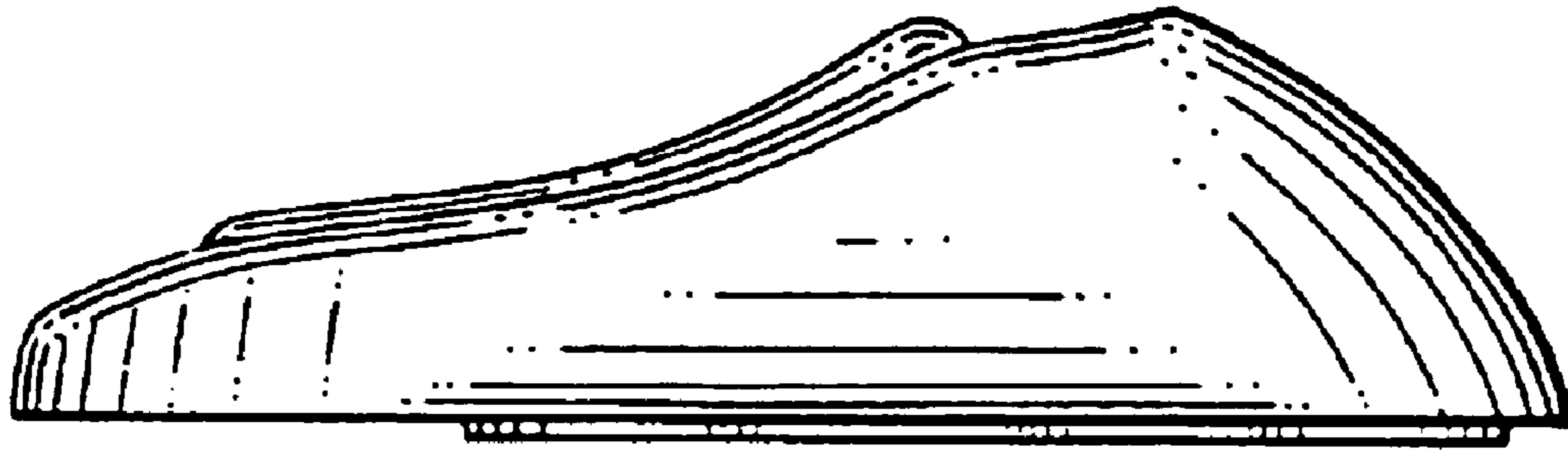

FIG. II

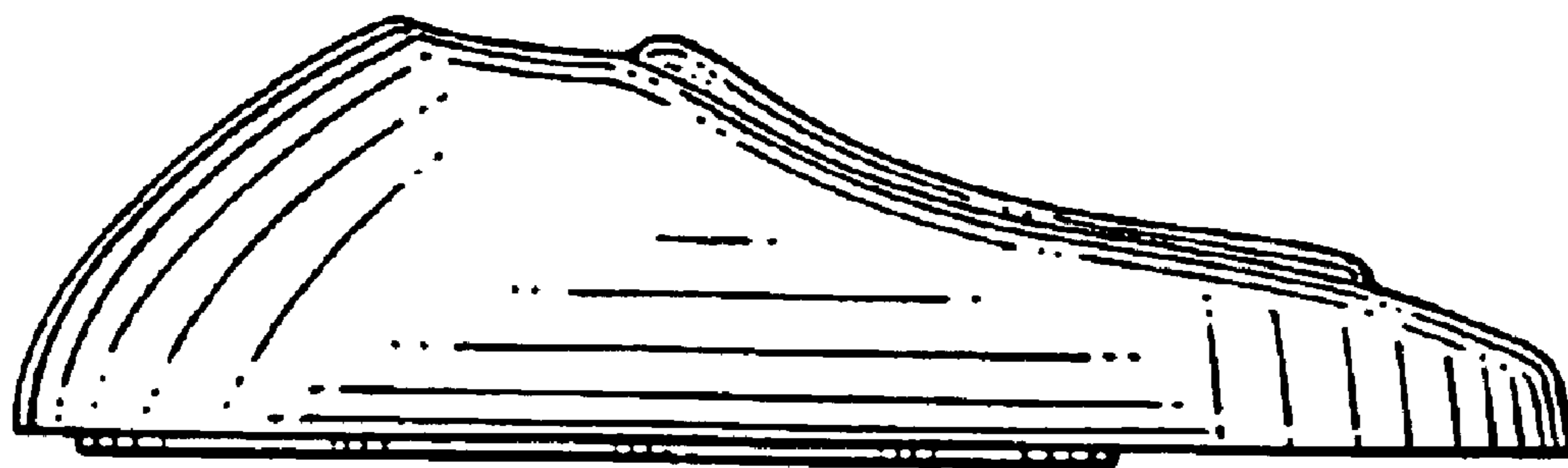

FIG. 12

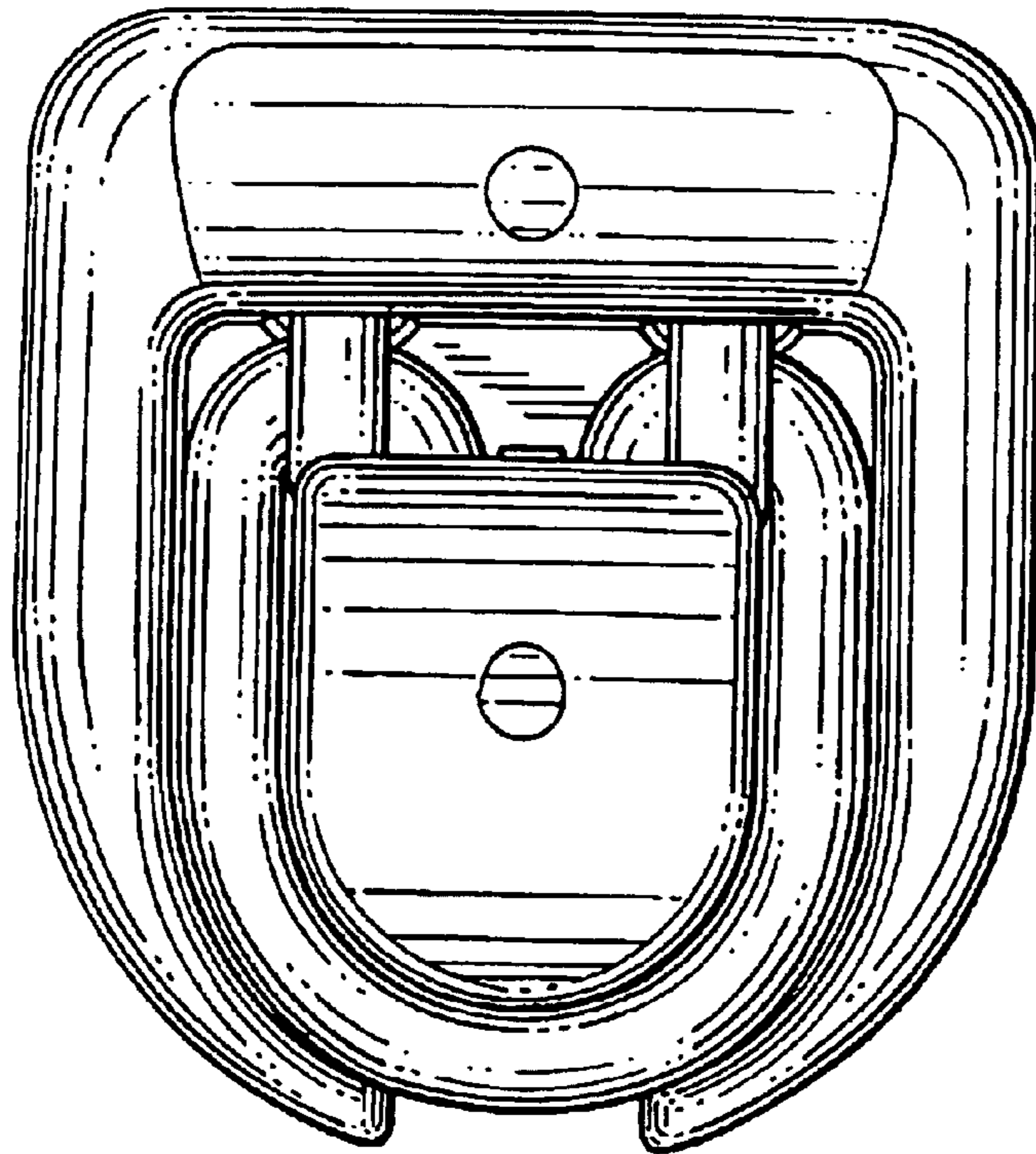

FIG. 13

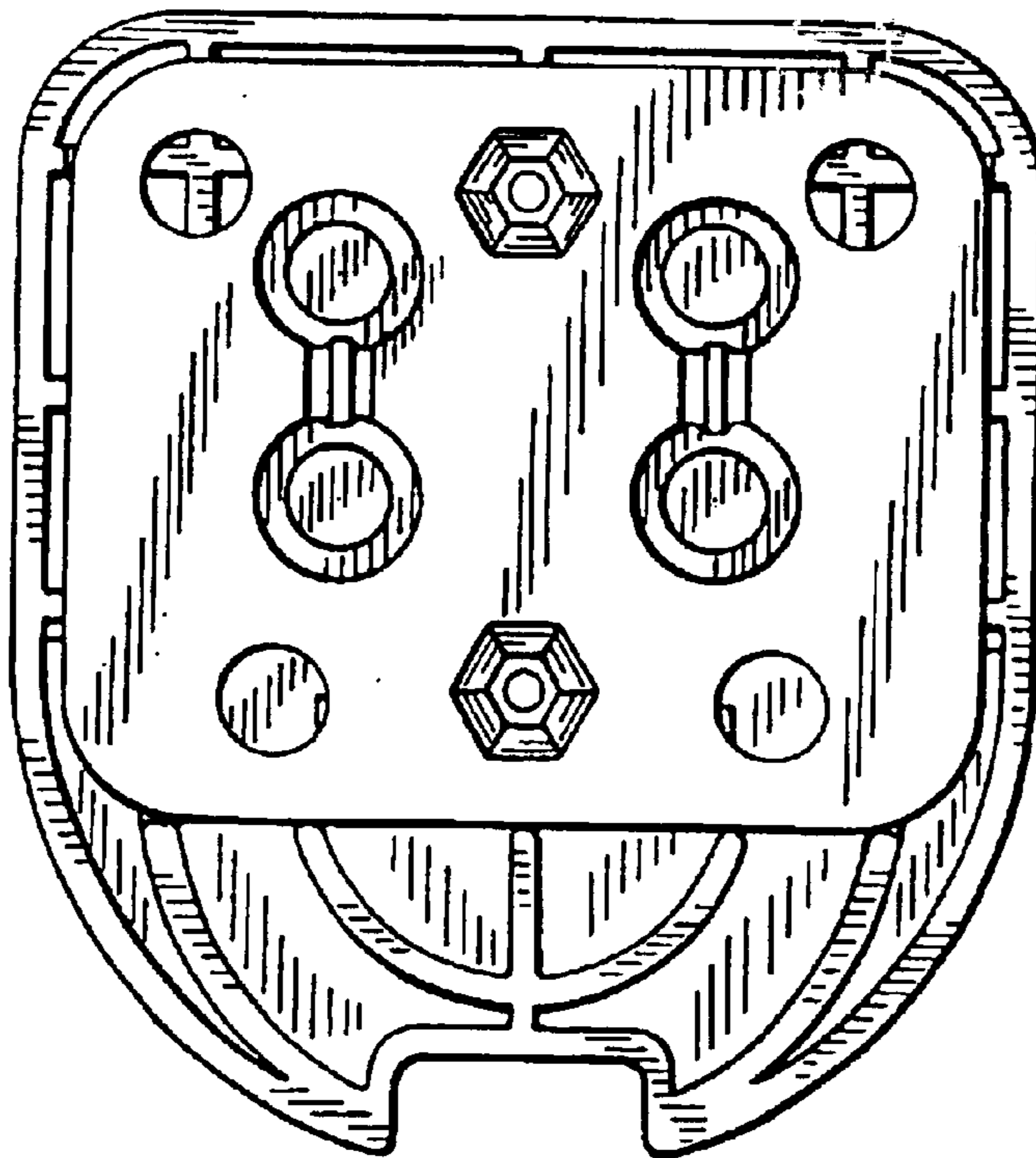

FIG. 14