

US00D492139S1

(12) **United States Design Patent**
McDiarmid

(10) **Patent No.:** **US D492,139 S**
(45) **Date of Patent:** **** Jun. 29, 2004**

(54) **STAND HAVING SHELVES**

(75) **Inventor:** **Ronald D. McDiarmid**, City of Industry, CA (US)

(73) **Assignee:** **Gruga, U.S.A.**, City of Industry, CA (US)

(**) **Term:** **14 Years**

(21) **Appl. No.:** **29/192,500**

(22) **Filed:** **Oct. 24, 2003**

(51) **LOC (7) Cl.** **06-04**

(52) **U.S. Cl.** **D6/479**

(58) **Field of Search** D6/464, 474-476, D6/477-479; 108/59, 60, 91, 92, 147.11, 149; 211/153, 186, 188, 194; 312/7.2, 9.1, 223.1

(56) **References Cited**

U.S. PATENT DOCUMENTS

D363,626 S	*	10/1995	Herbst	D6/479
D368,397 S	*	4/1996	Weberg	D6/479
D371,259 S	*	7/1996	Herbst	D6/479
D371,472 S	*	7/1996	Herbst	D6/480
D405,630 S	*	2/1999	Wohlford	D6/479
D471,739 S	*	3/2003	de Carolis	D6/479
D472,073 S	*	3/2003	de Carolis	D6/479
D483,581 S	*	12/2003	Chang	D6/479

* cited by examiner

Primary Examiner—Cathron Brooks

(74) *Attorney, Agent, or Firm*—Sheppard, Mullin, Richter & Hampton LLP

(57) **CLAIM**

I claim the ornamental design for a stand having shelves, as shown and described.

DESCRIPTION

FIG. 1 is a front right perspective view of a stand having shelves embodying our new design.

FIG. 2 is a front elevational view of the stand of FIG. 1.

FIG. 3 is a rear elevational view of the stand of FIG. 1.

FIG. 4 is a right side elevational view of the stand of FIG. 1.

FIG. 5 is a left side elevational view of the stand of FIG. 1.

FIG. 6 is a top plan view of the stand of FIG. 1.

FIG. 7 is a bottom plan view of the stand of FIG. 1.

FIG. 8 is a front right perspective view of an alternative embodiment of the stand of FIG. 1.

FIG. 9 is a front elevational view of the stand of FIG. 8.

FIG. 10 is a rear elevational view of the stand of FIG. 8.

FIG. 11 is a right side elevational view of the stand of FIG. 8.

FIG. 12 is a left side elevational view of the stand of FIG. 8.

FIG. 13 is a top plan view of the stand of FIG. 8; and,

FIG. 14 is a bottom plan view of the stand of FIG. 8.

1 Claim, 8 Drawing Sheets

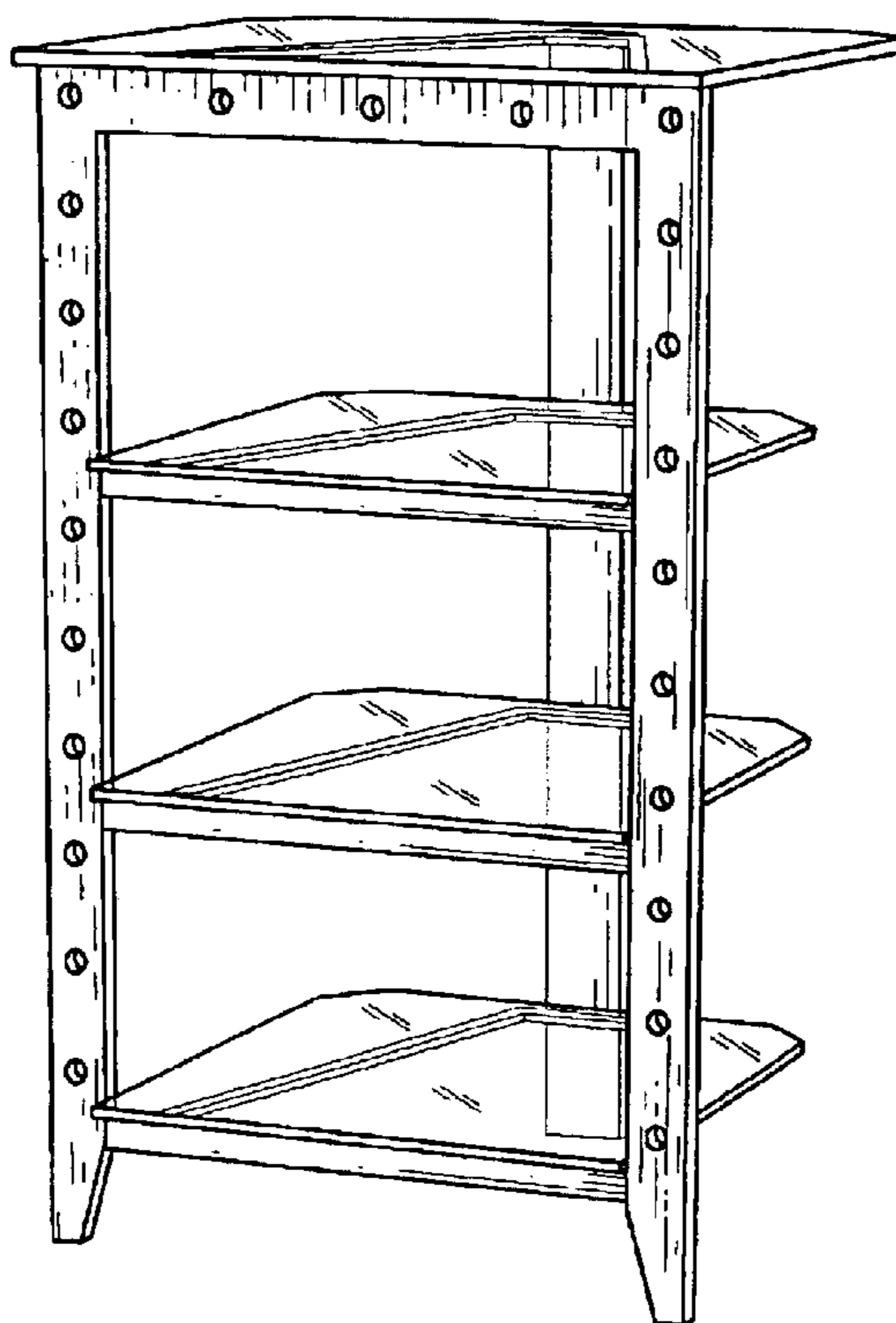

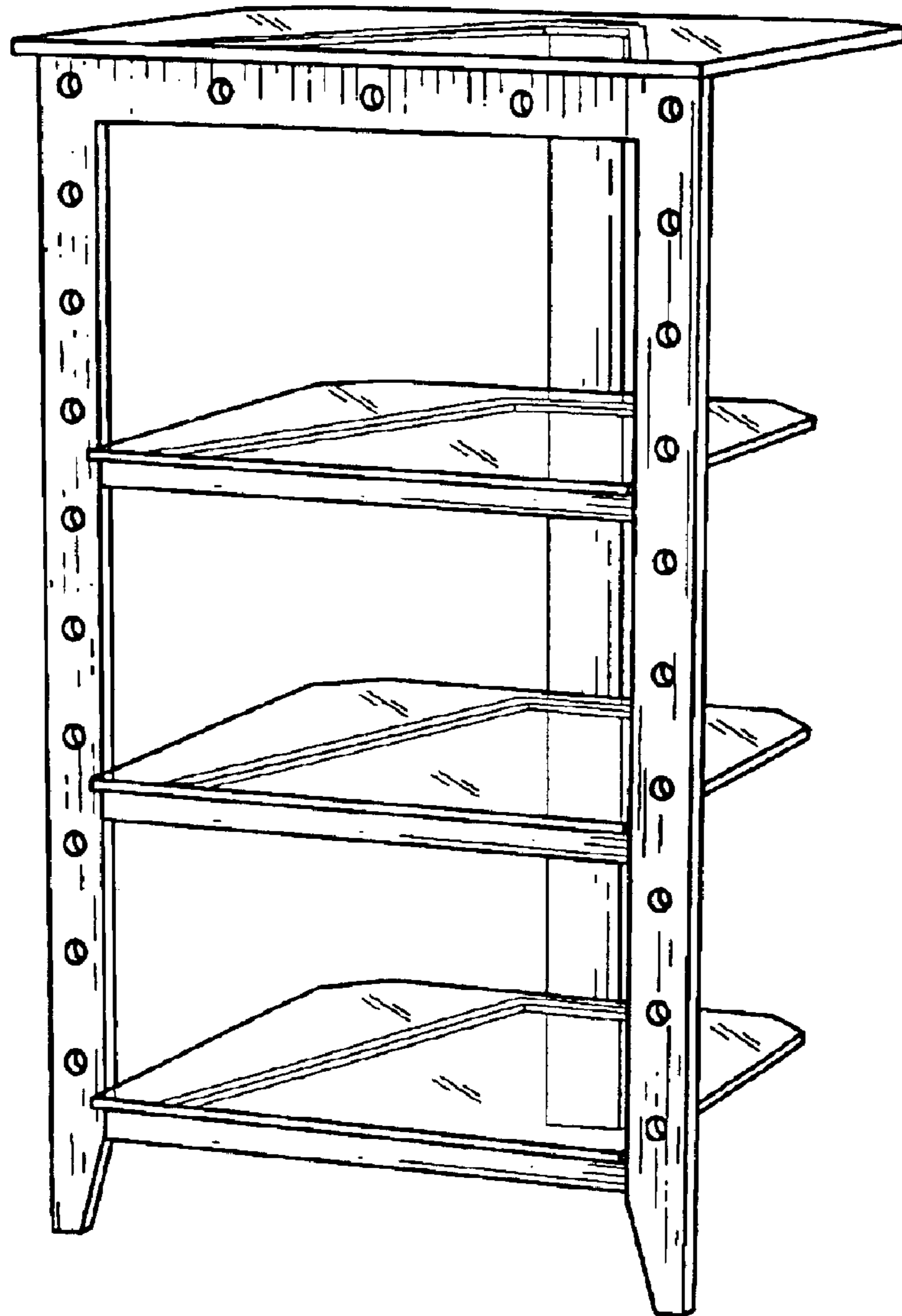

FIG. 1

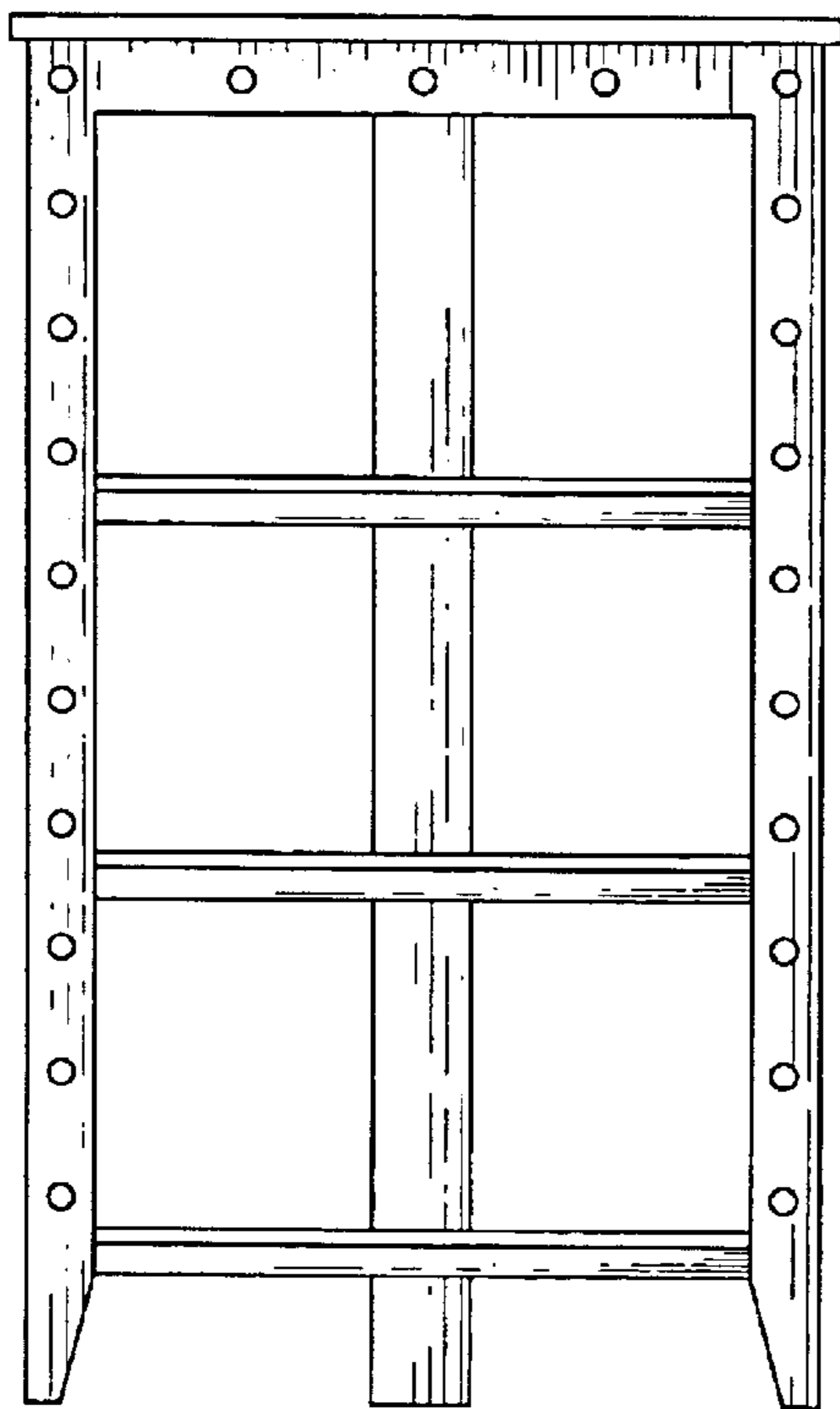

FIG. 2

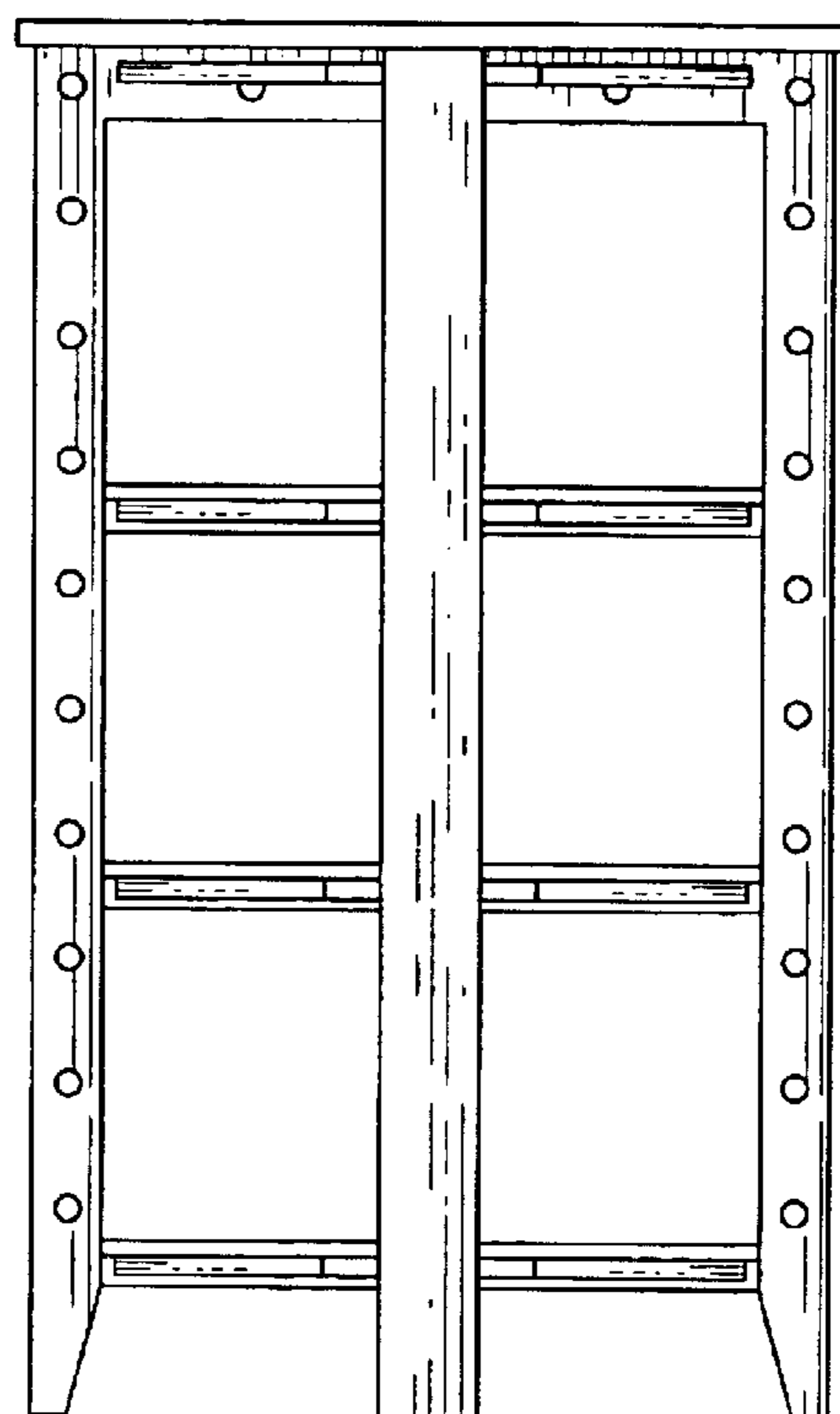

FIG. 3

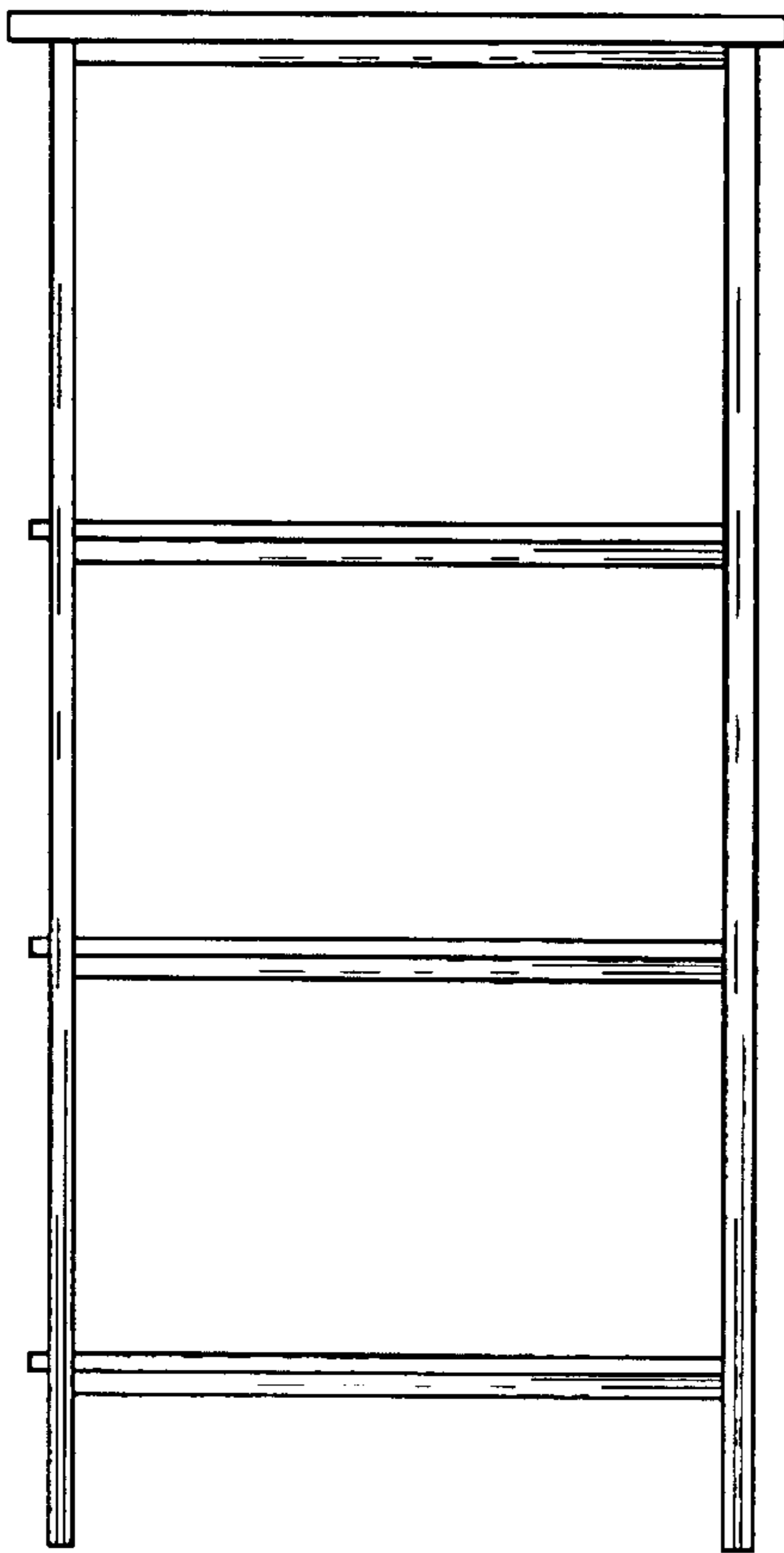

FIG. 4

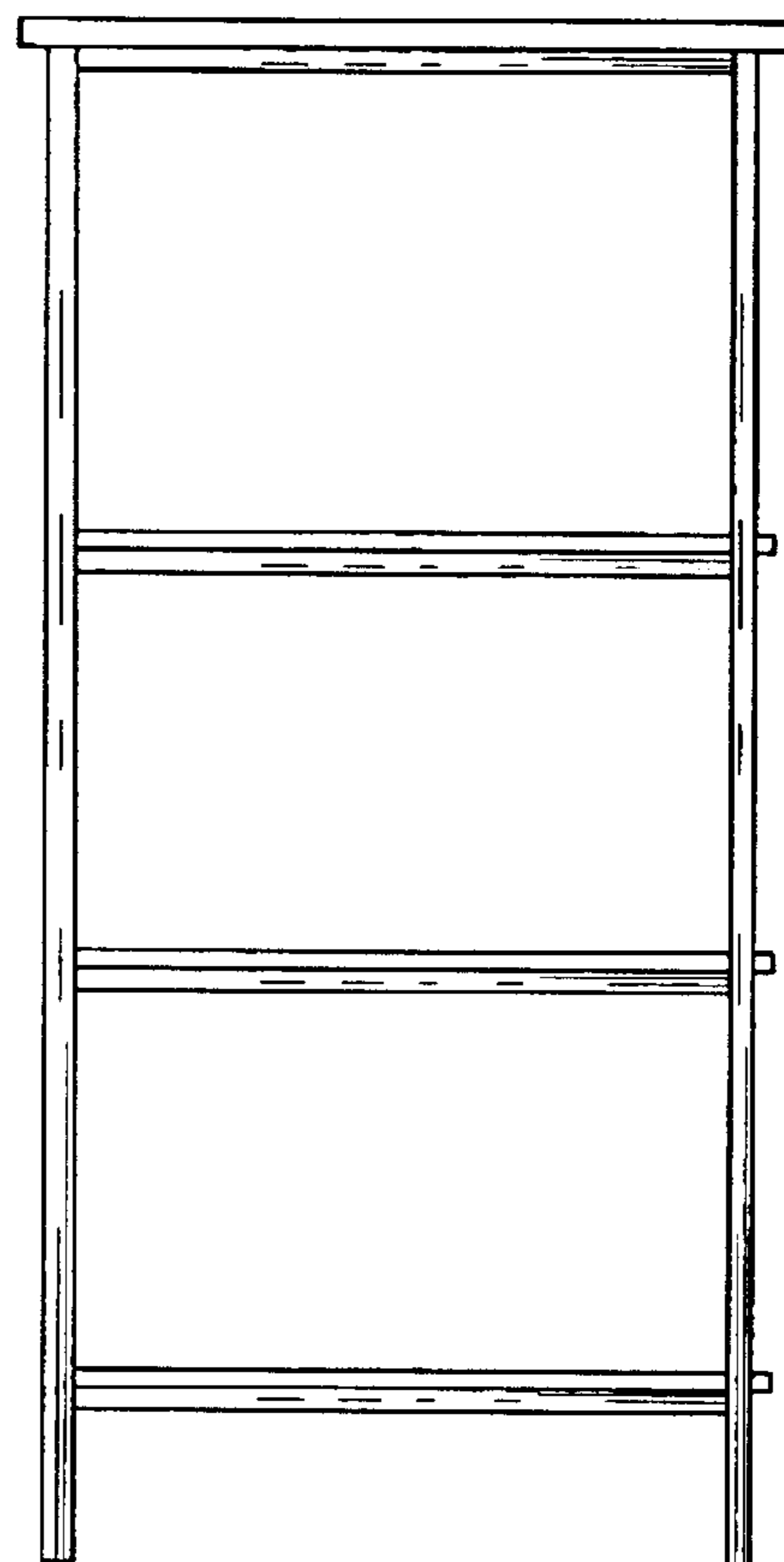

FIG. 5

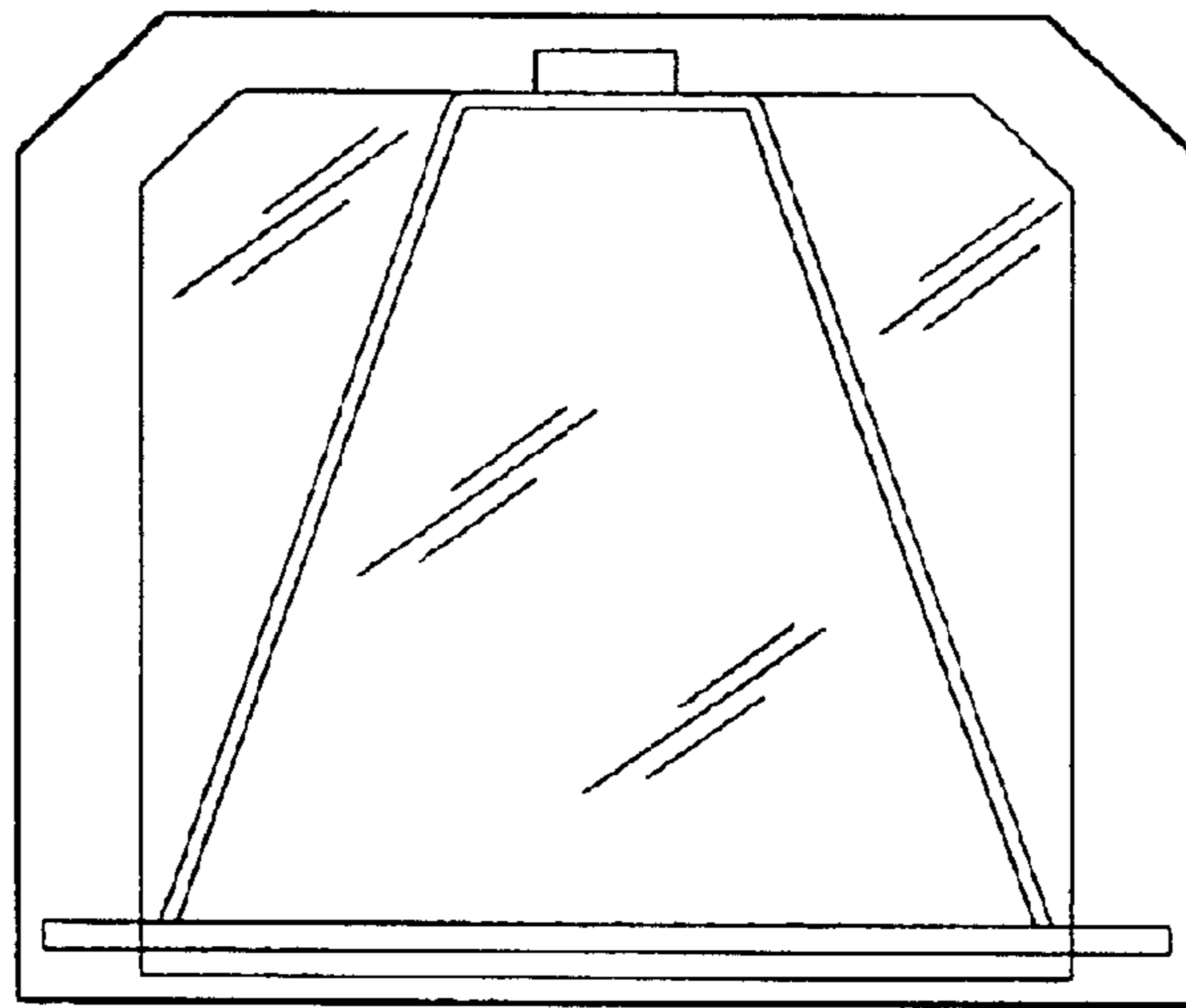

FIG. 6

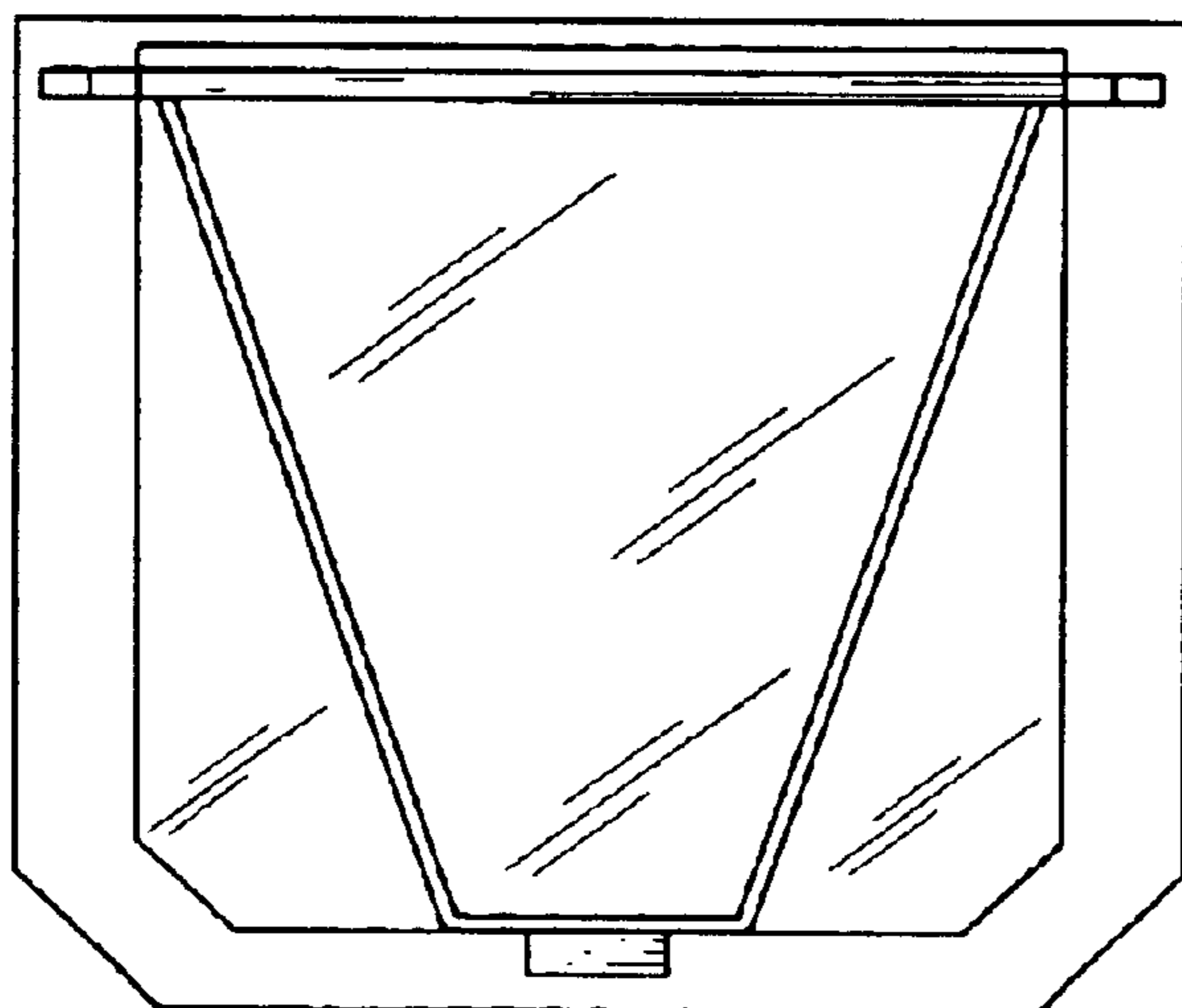

FIG. 7

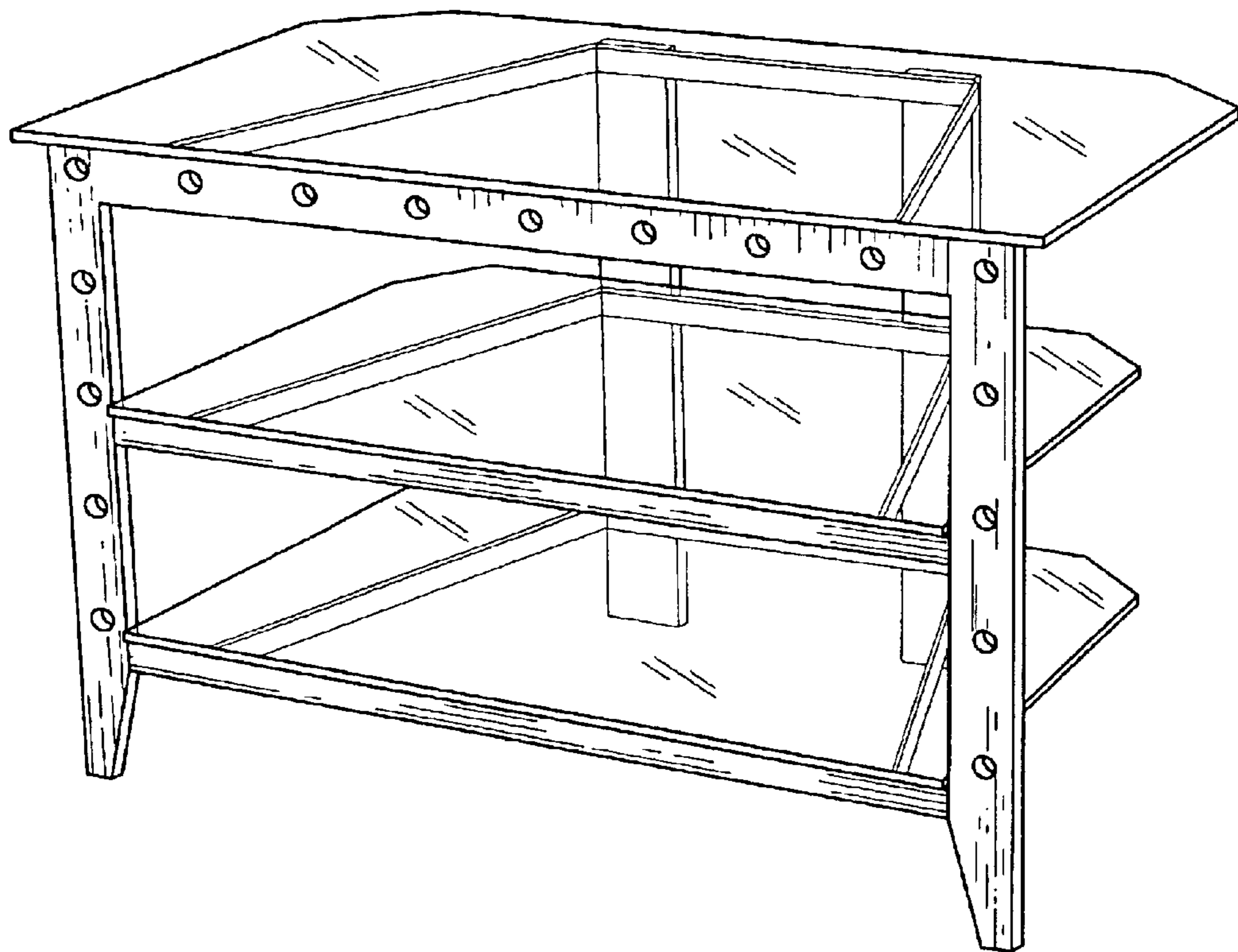

FIG. 8

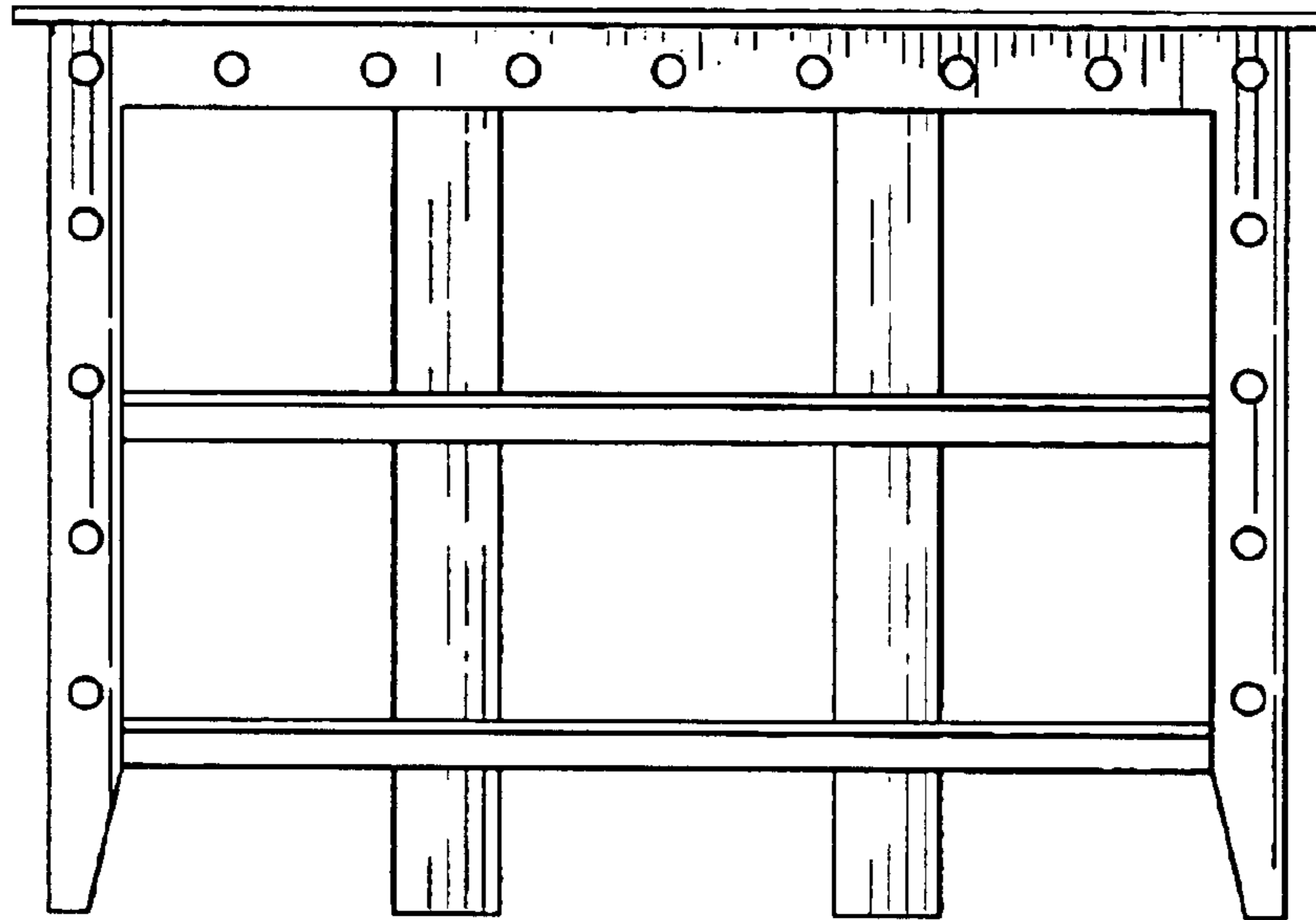

FIG. 9

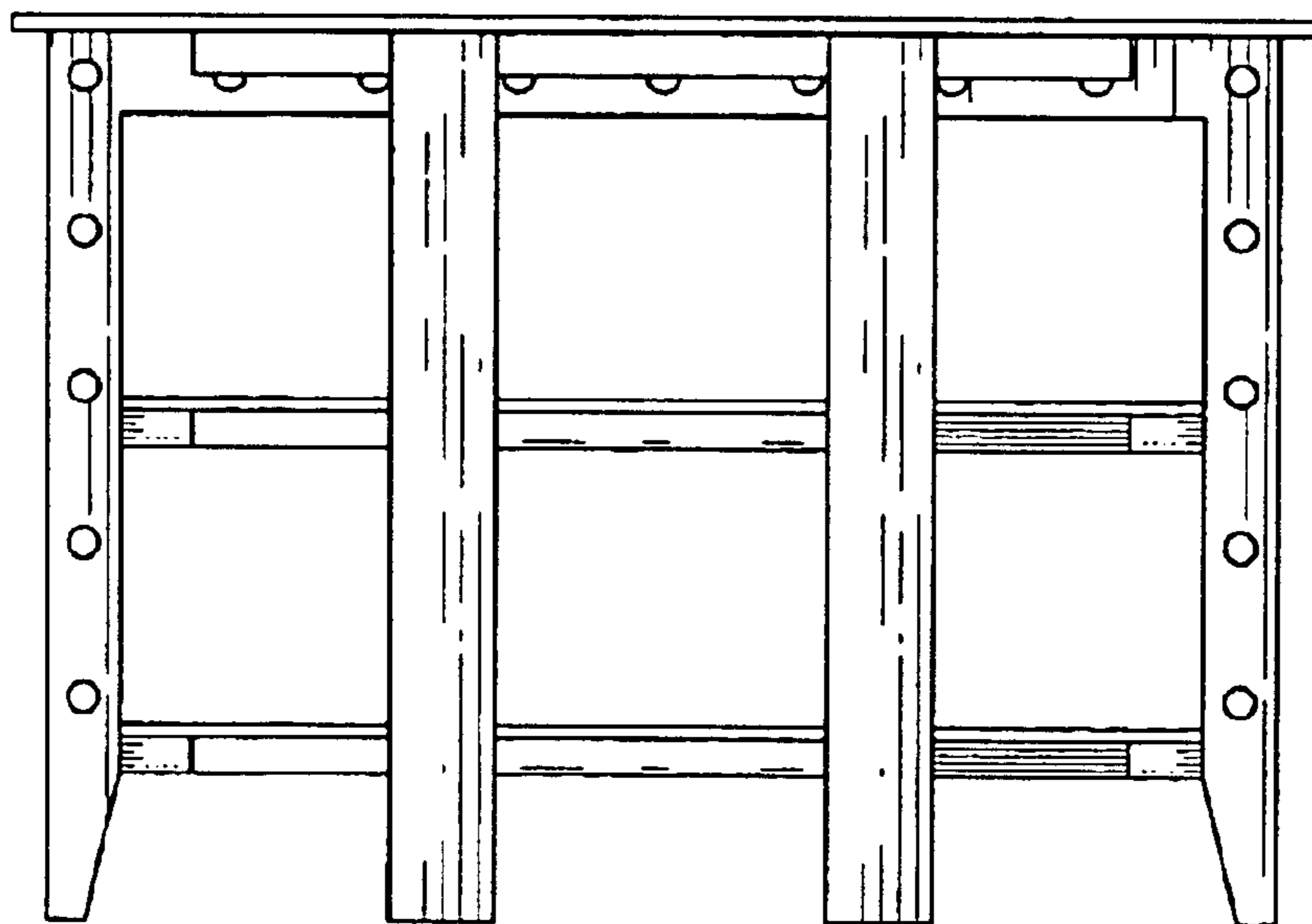

FIG. 10

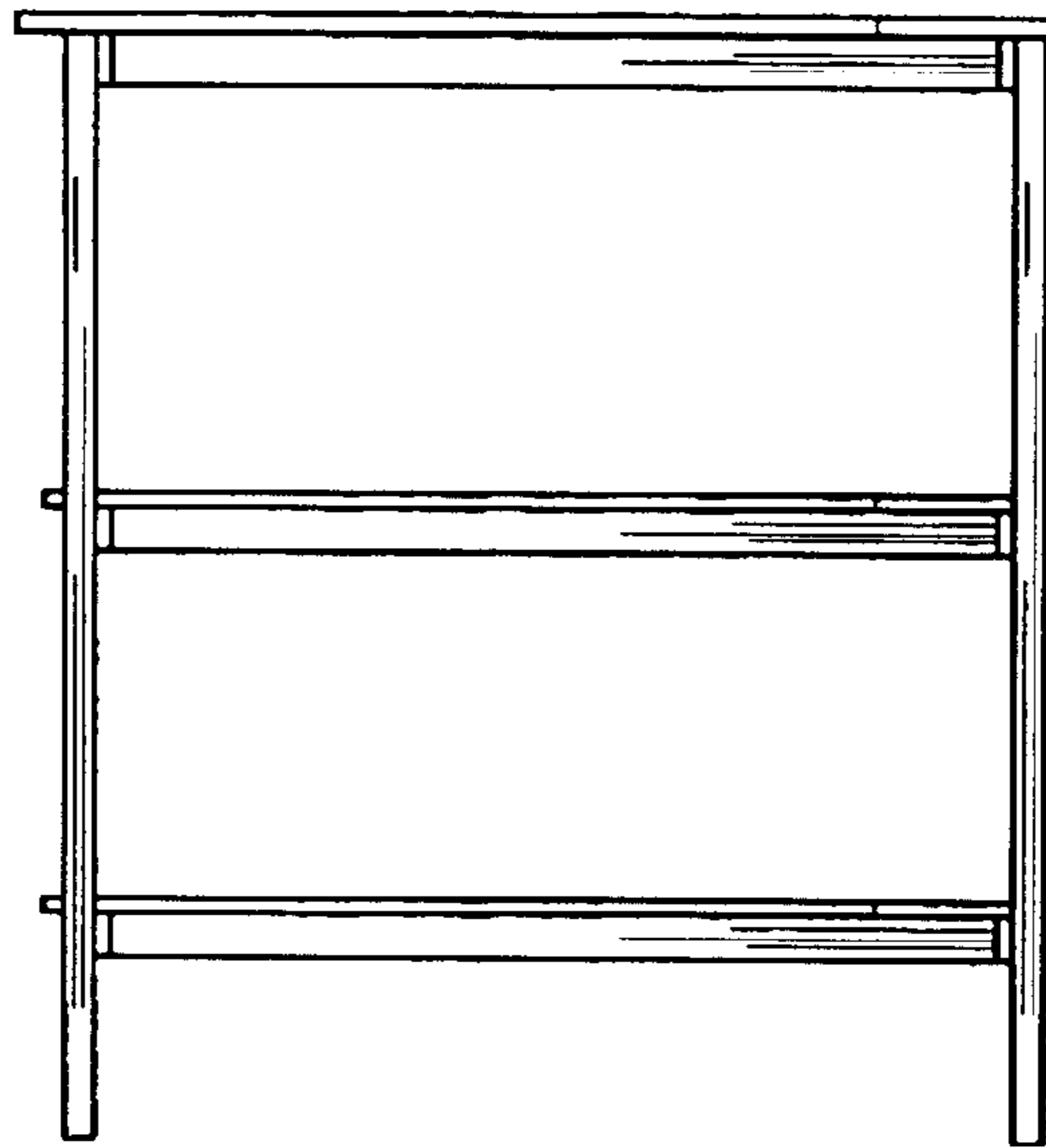

FIG. 11

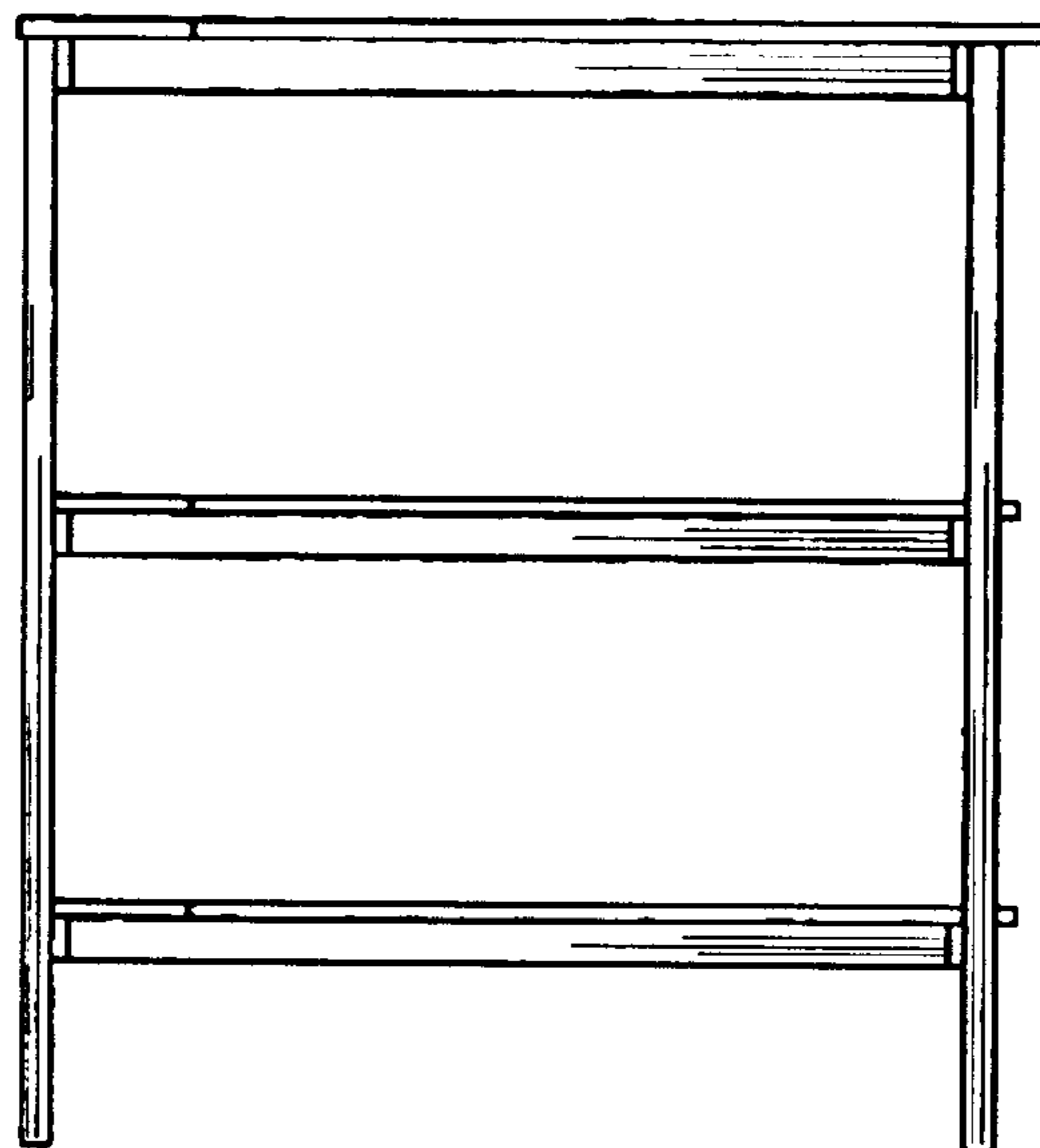

FIG. 12

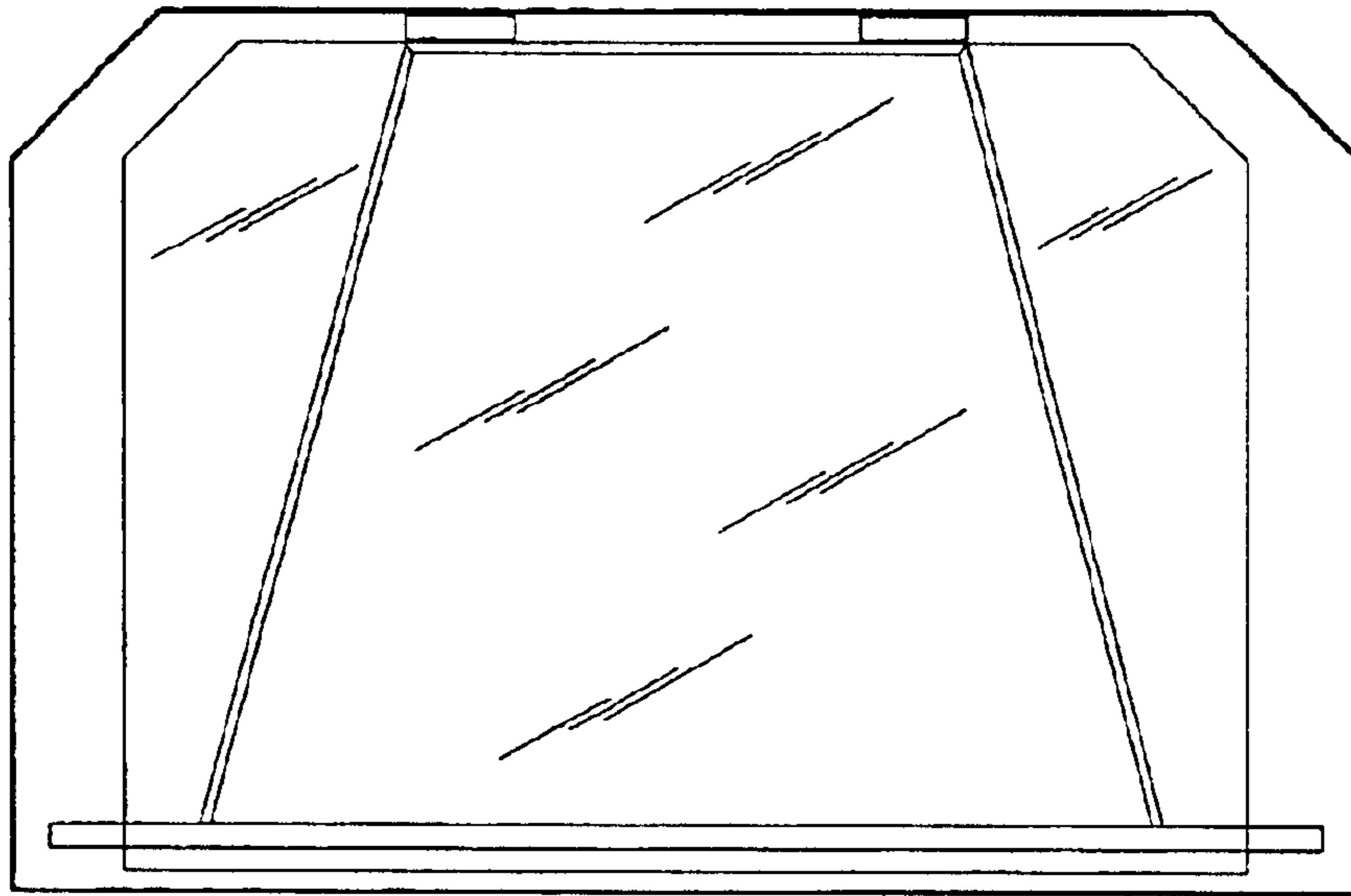

FIG. 13

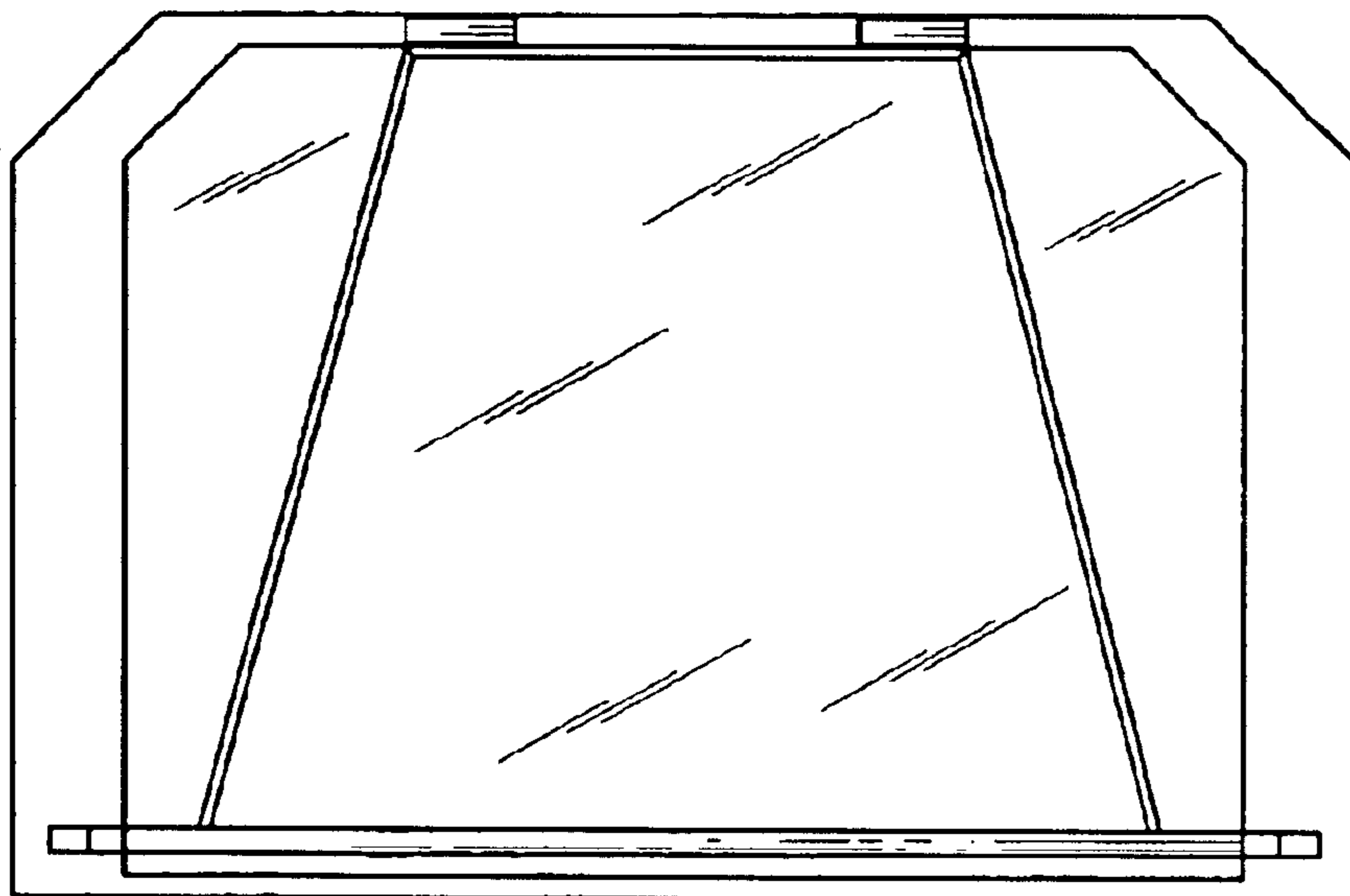

FIG. 14