

US00D492083S1

(12) **United States Design Patent**
Coffey

(10) **Patent No.:** **US D492,083 S**
(45) **Date of Patent:** **** Jun. 22, 2004**

(54) **COIN BANK**

(76) **Inventor:** **Leota W. Coffey**, 3455 Millers Gap Hwy., Newland, NC (US) 28657

(**) **Term:** **14 Years**

(21) **Appl. No.:** **29/187,277**

(22) **Filed:** **Jul. 30, 2003**

Related U.S. Application Data

(62) Division of application No. 29/153,970, filed on Jan. 15, 2002, now Pat. No. Des. 481,190.

(51) **LOC (7) Cl.** **99-00**

(52) **U.S. Cl.** **D99/37**

(58) **Field of Search** D99/28, 34, 35, D99/36, 37, 41; 446/8, 9, 10; 232/4 R

(56) **References Cited**

U.S. PATENT DOCUMENTS

- D12,860 S * 4/1882 Kyser et al. D99/37
- D348,970 S * 7/1994 Gaillard et al. D99/37
- D350,006 S * 8/1994 Wan D99/37
- D414,009 S * 9/1999 Saign et al. D99/37

* cited by examiner

Primary Examiner—Paula A. Greene

(74) *Attorney, Agent, or Firm*—Nelson Mullins Riley & Scarborough

(57) **CLAIM**

The ornamental design of a coin bank, substantially as shown and described.

DESCRIPTION

FIG. 1 is a perspective view of a coin bank embodying the design of the present invention.

FIG. 2 is a front side elevational view of the coin bank illustrated in FIG. 1.

FIG. 3 is a back side elevational view of the coin bank illustrated in FIG. 1.

FIG. 4 is a left side elevational view of the coin bank illustrated in FIG. 1.

FIG. 5 is a right side elevational view of the coin bank illustrated in FIG. 1.

FIG. 6 is a top view of the coin bank illustrated in FIG. 1; and,

FIG. 7 is a bottom view of the coin bank illustrated in FIG. 1.

The portions shown in broken lines do not form a part of the claimed design.

1 Claim, 3 Drawing Sheets

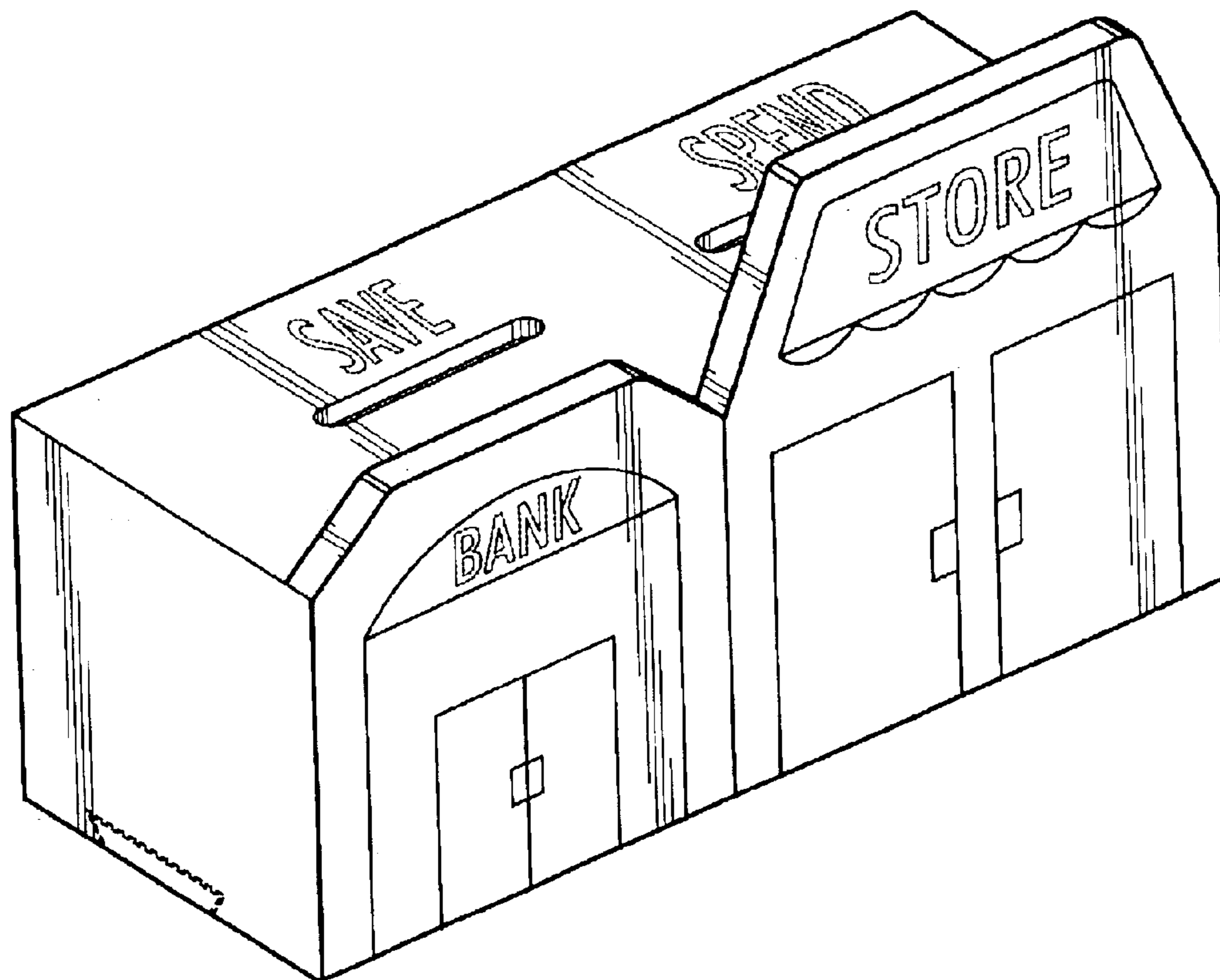

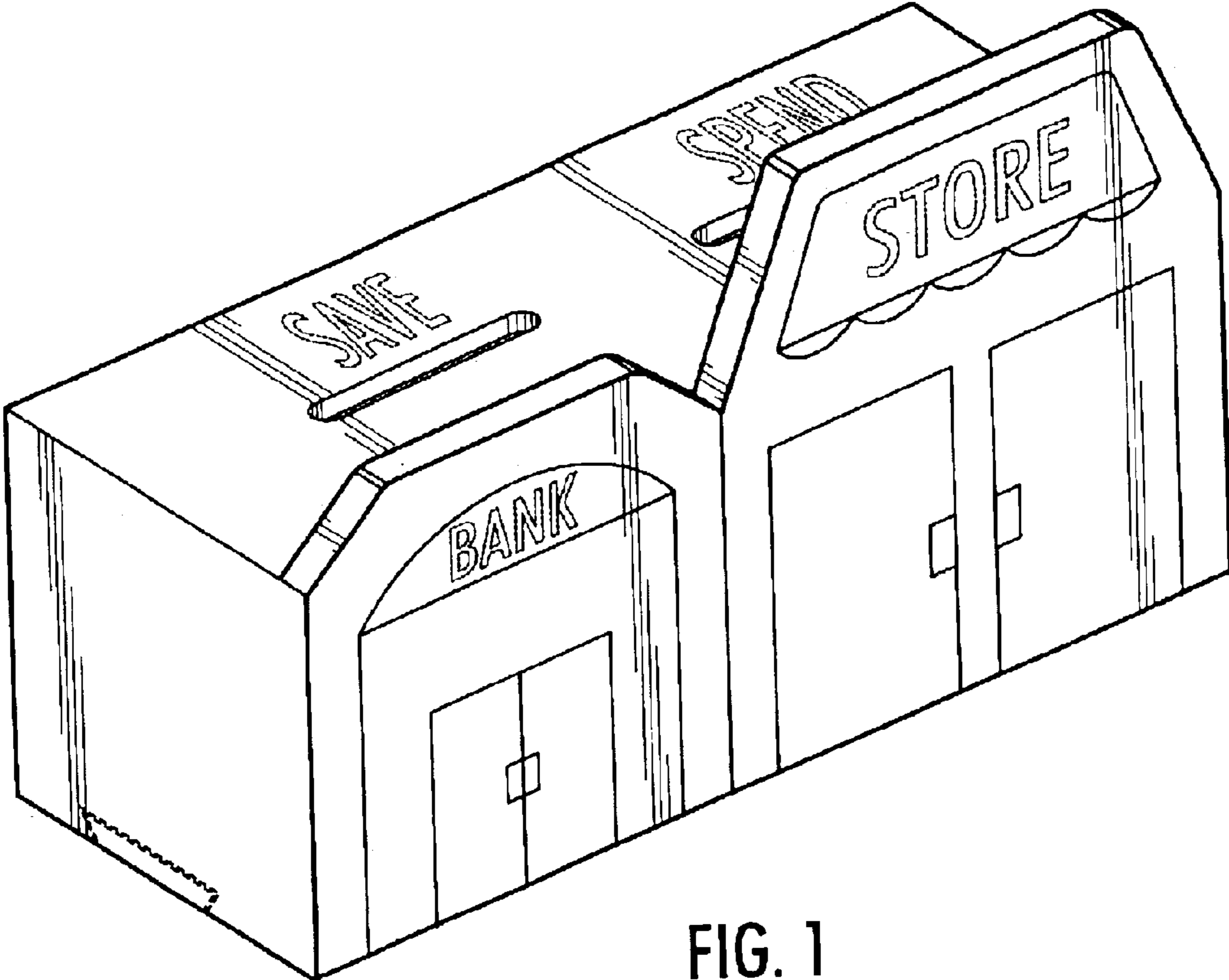

FIG. 1



FIG. 2

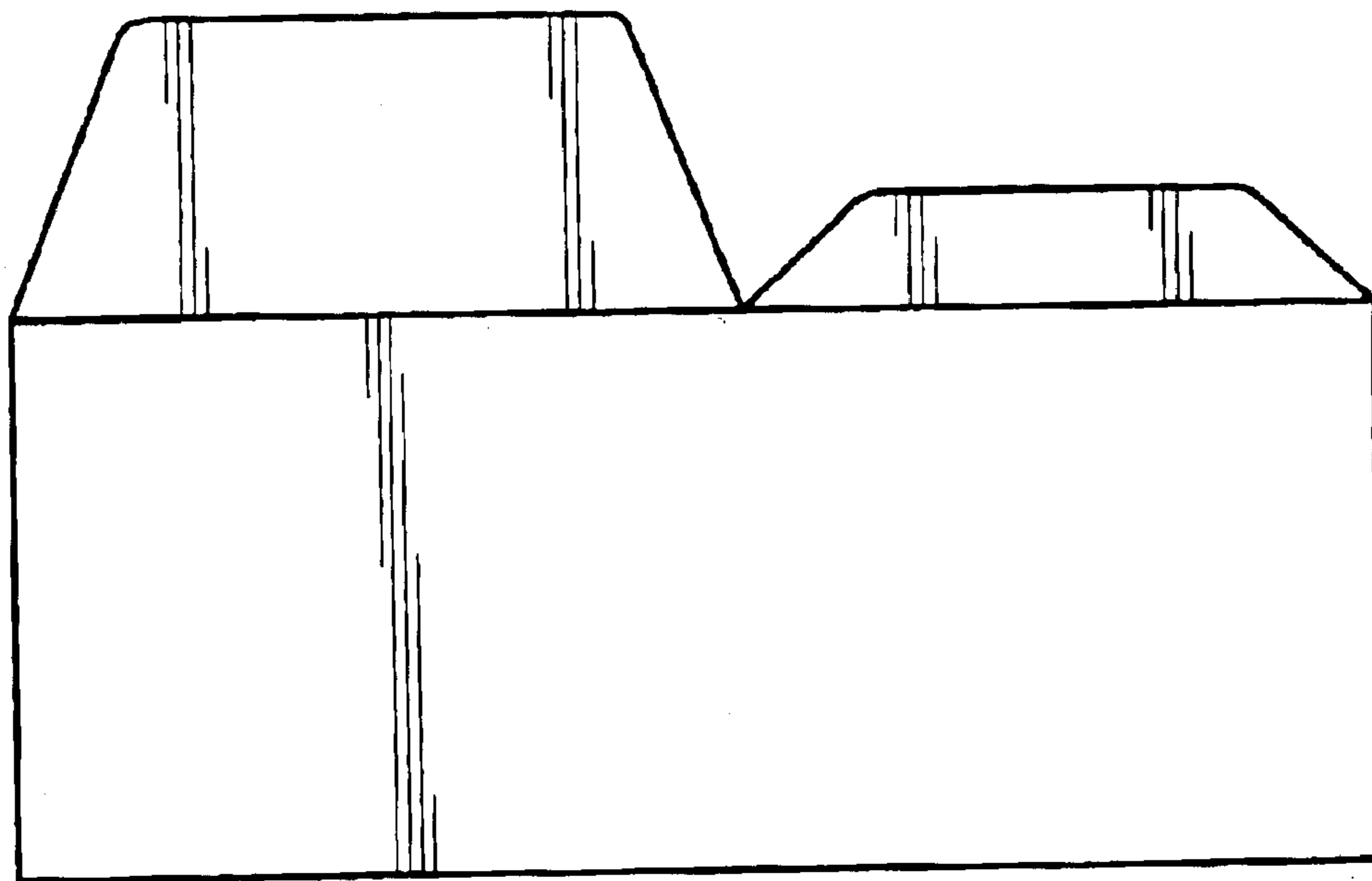

FIG. 3

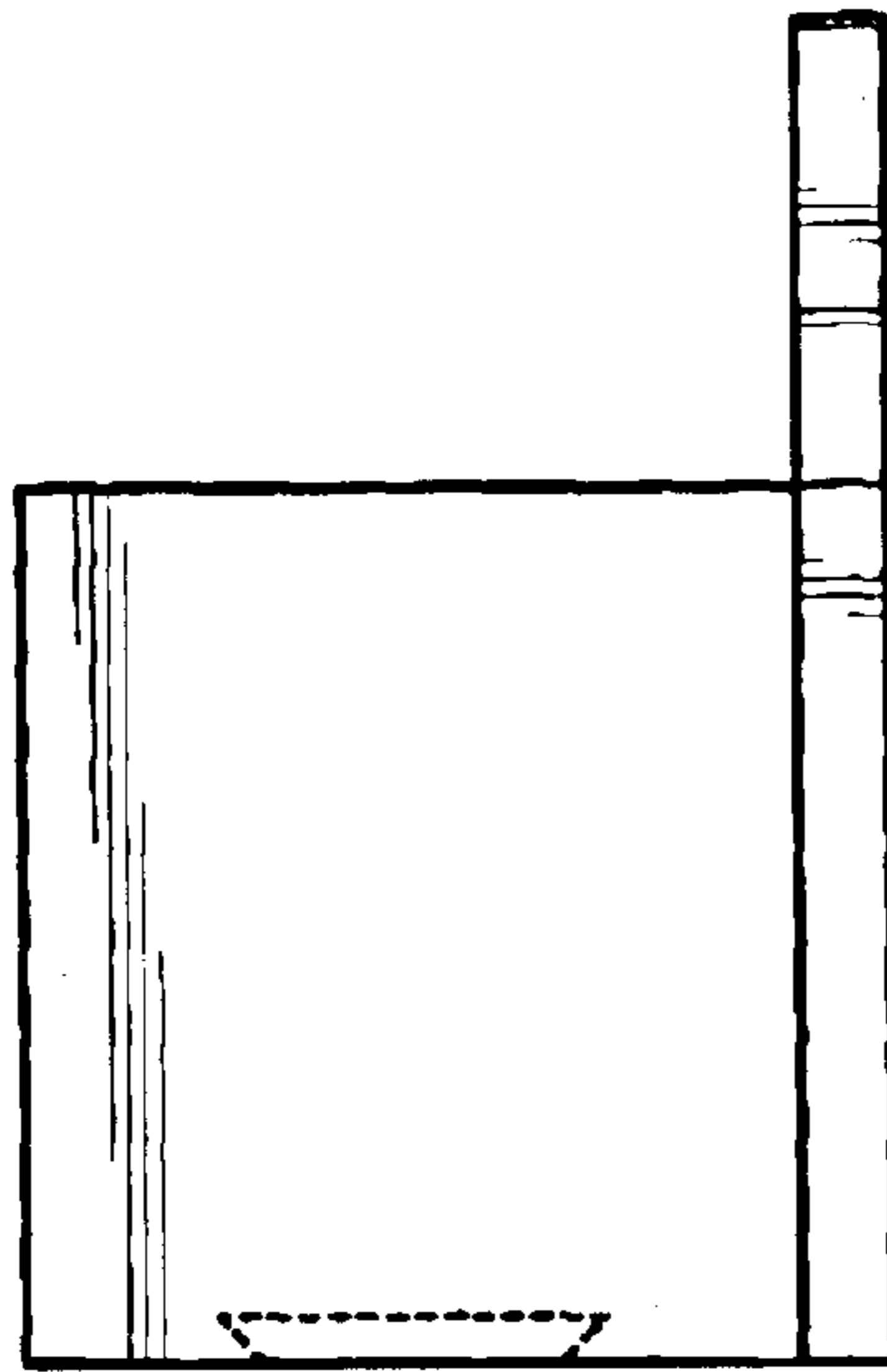

FIG. 4

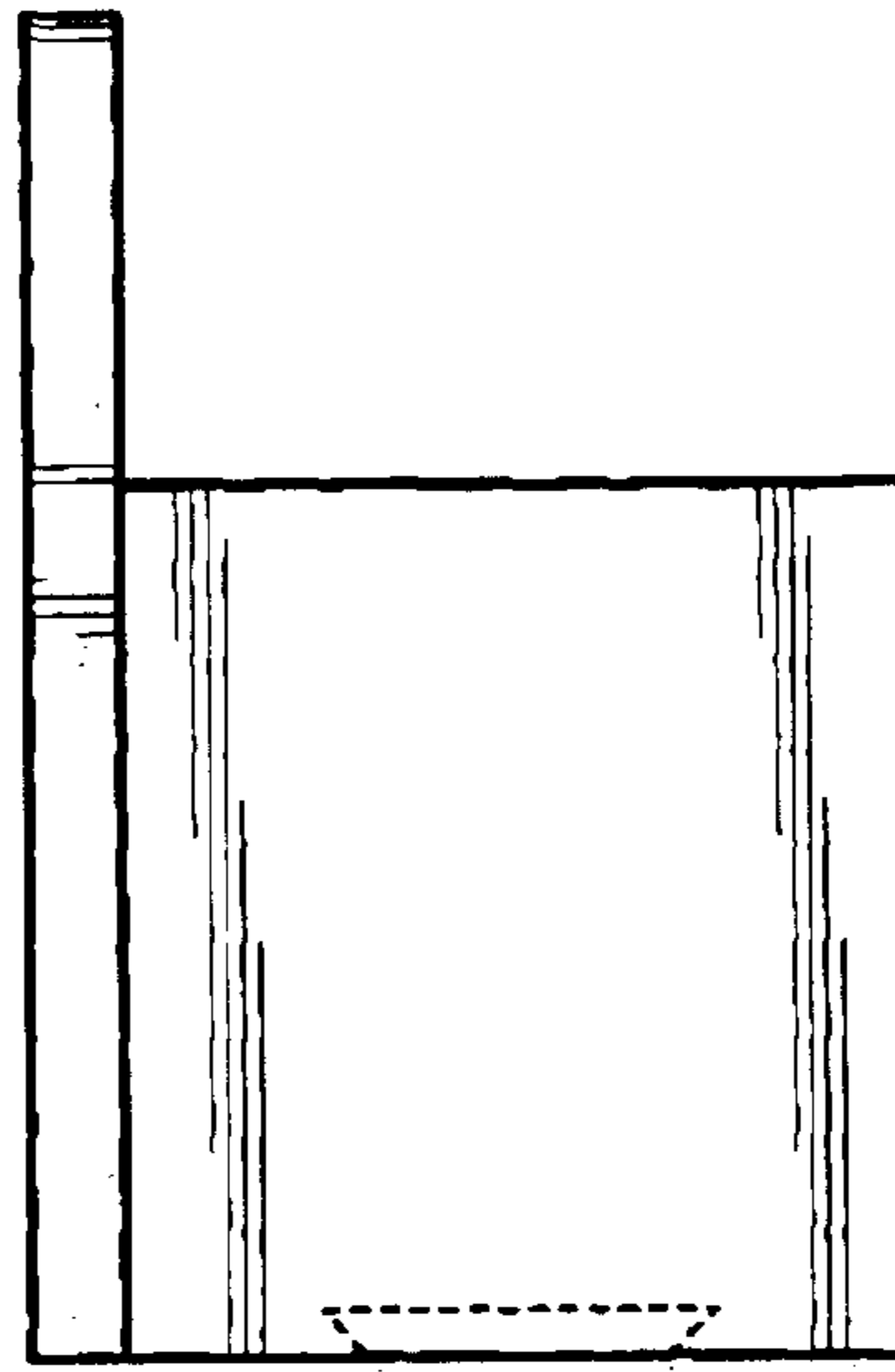

FIG. 5

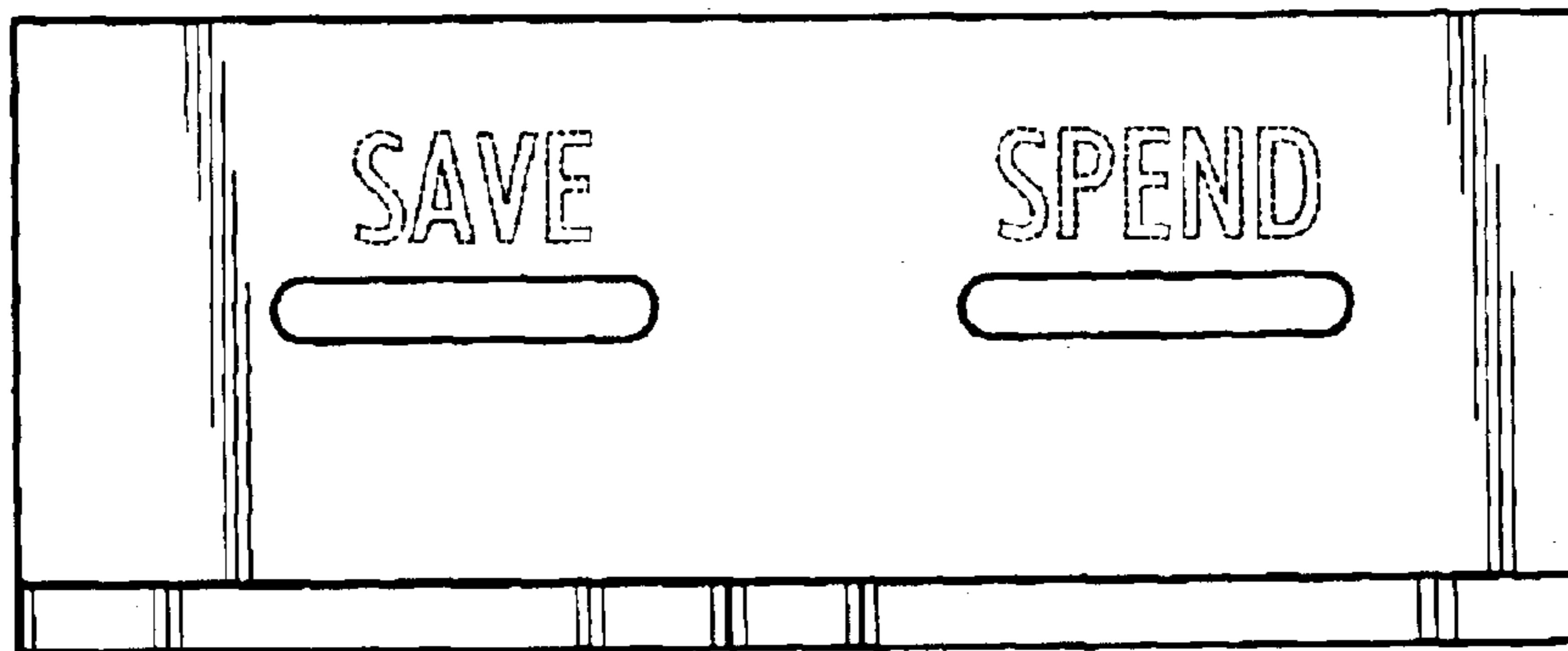

FIG. 6

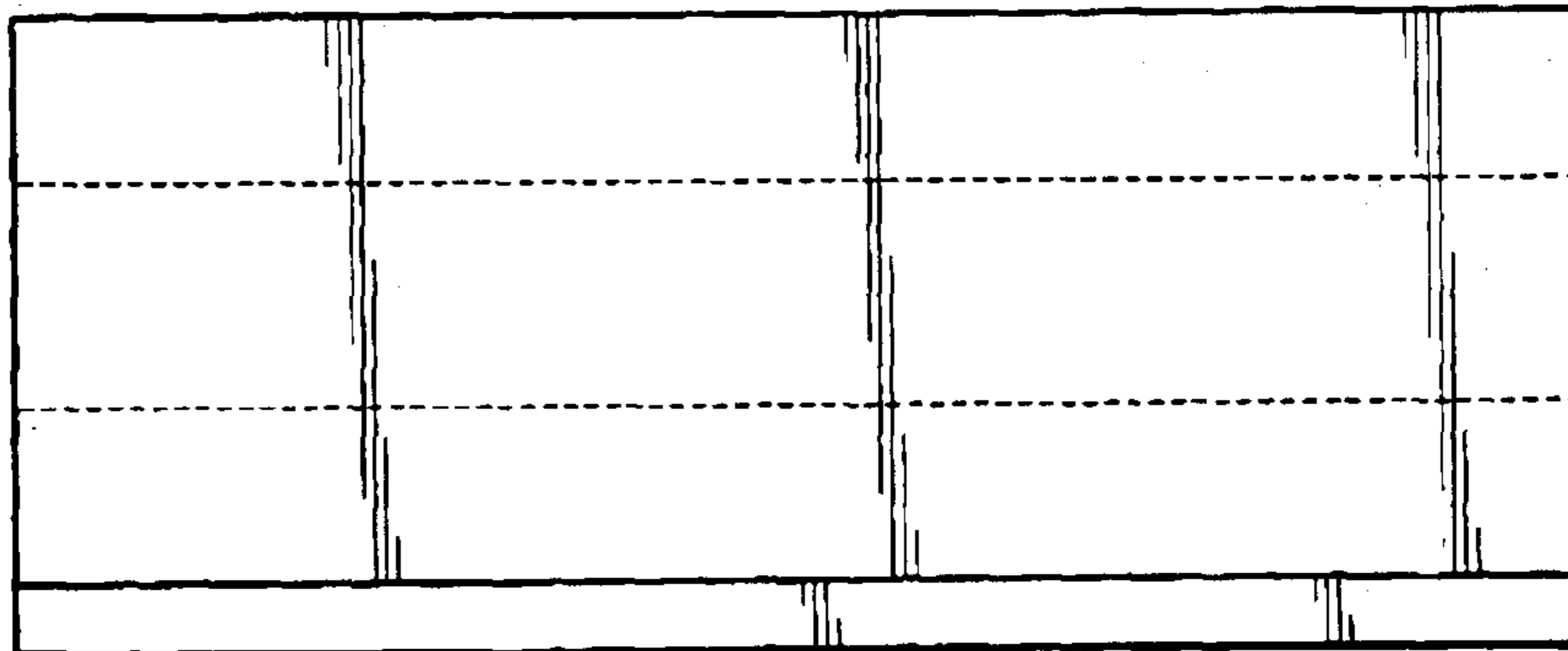

FIG. 7