



US00D492008S1

(12) **United States Design Patent**
Haug et al.

(10) **Patent No.:** **US D492,008 S**
(45) **Date of Patent:** **** Jun. 22, 2004**

(54) **HEAD SHOWER**

D465,551 S * 11/2002 Tse D23/229
D475,119 S * 5/2003 Colligan et al. D23/213

(75) Inventors: **Andreas Haug**, Stuttgart (DE); **Tom Schönherr**, Stuttgart (DE); **Fabian Kollmann**, Stuttgart (DE)

* cited by examiner

(73) Assignee: **Hansgrohe AG**, Schiltach (DE)

Primary Examiner—Robin V. Taylor
(74) *Attorney, Agent, or Firm*—Duane Morris LLP

(**) Term: **14 Years**

(57) **CLAIM**

(21) Appl. No.: **29/183,501**

The ornamental design for a head shower, as shown and described.

(22) Filed: **Jun. 11, 2003**

DESCRIPTION

(30) **Foreign Application Priority Data**

Dec. 12, 2002 (DE) 402 10 283

FIG. 1: is a side perspective view of the head shower showing our new design;

(51) **LOC (7) Cl.** **23-01**

FIG. 2: is a side elevation view thereof;

(52) **U.S. Cl.** **D23/229**

FIG. 3: is a front elevation view thereof;

(58) **Field of Search** D23/213, 229,
D23/230, 223; 239/282-3, 548, 550

FIG. 4: is a bottom plan view thereof;

FIG. 5: is a rear elevation view thereof; and,

FIG. 6: is a top plan view thereof.

(56) **References Cited**

U.S. PATENT DOCUMENTS

6,382,531 B1 * 5/2002 Tracy 239/548

1 Claim, 3 Drawing Sheets

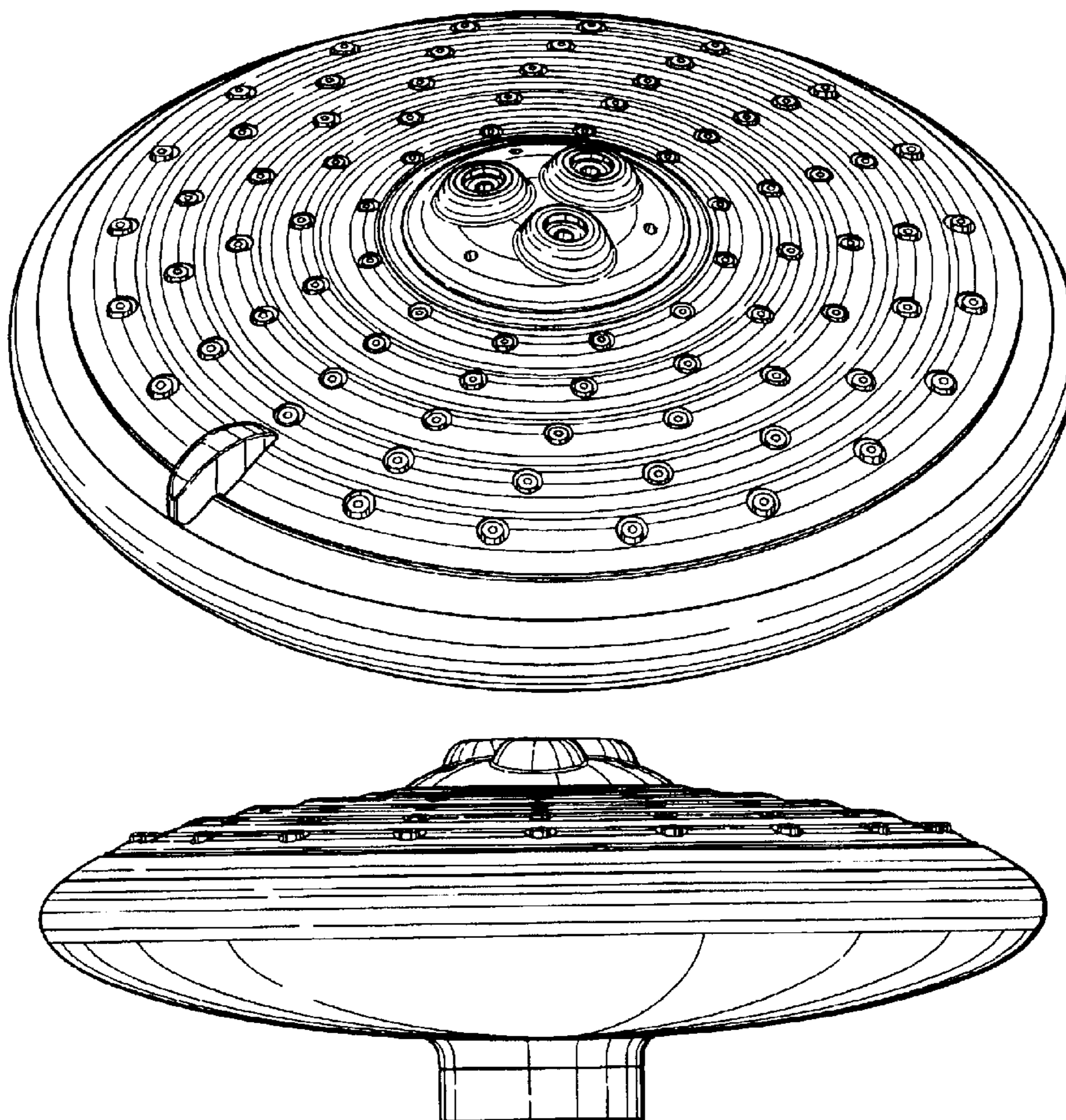

FIG. 1

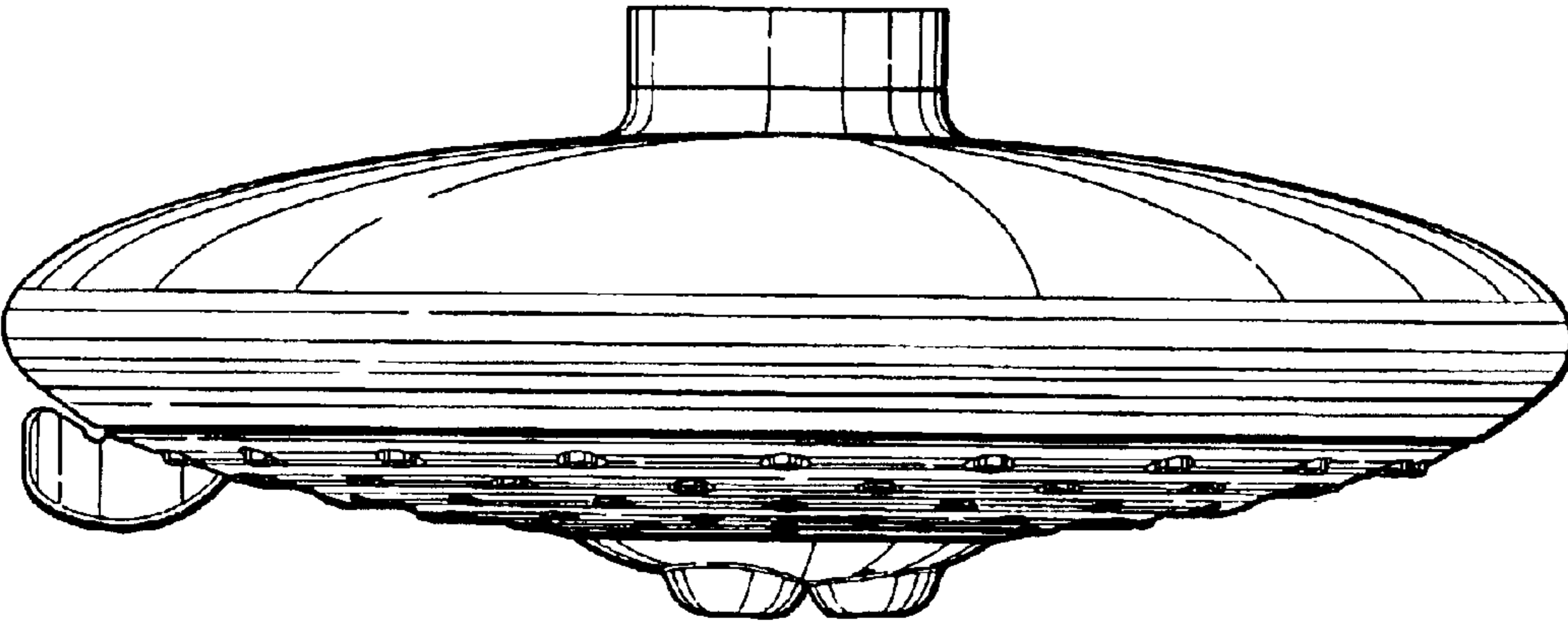
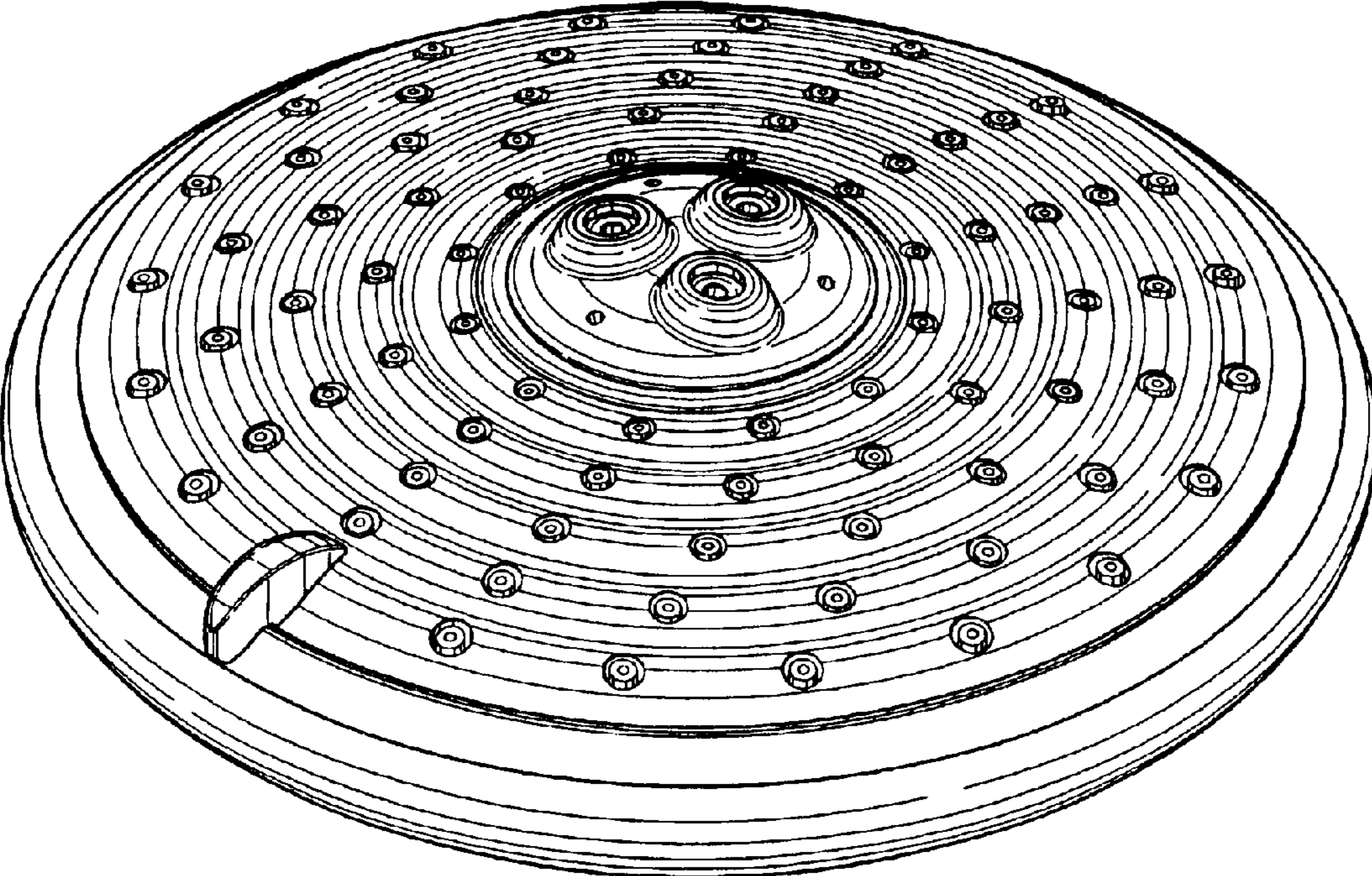

FIG. 2

FIG. 3

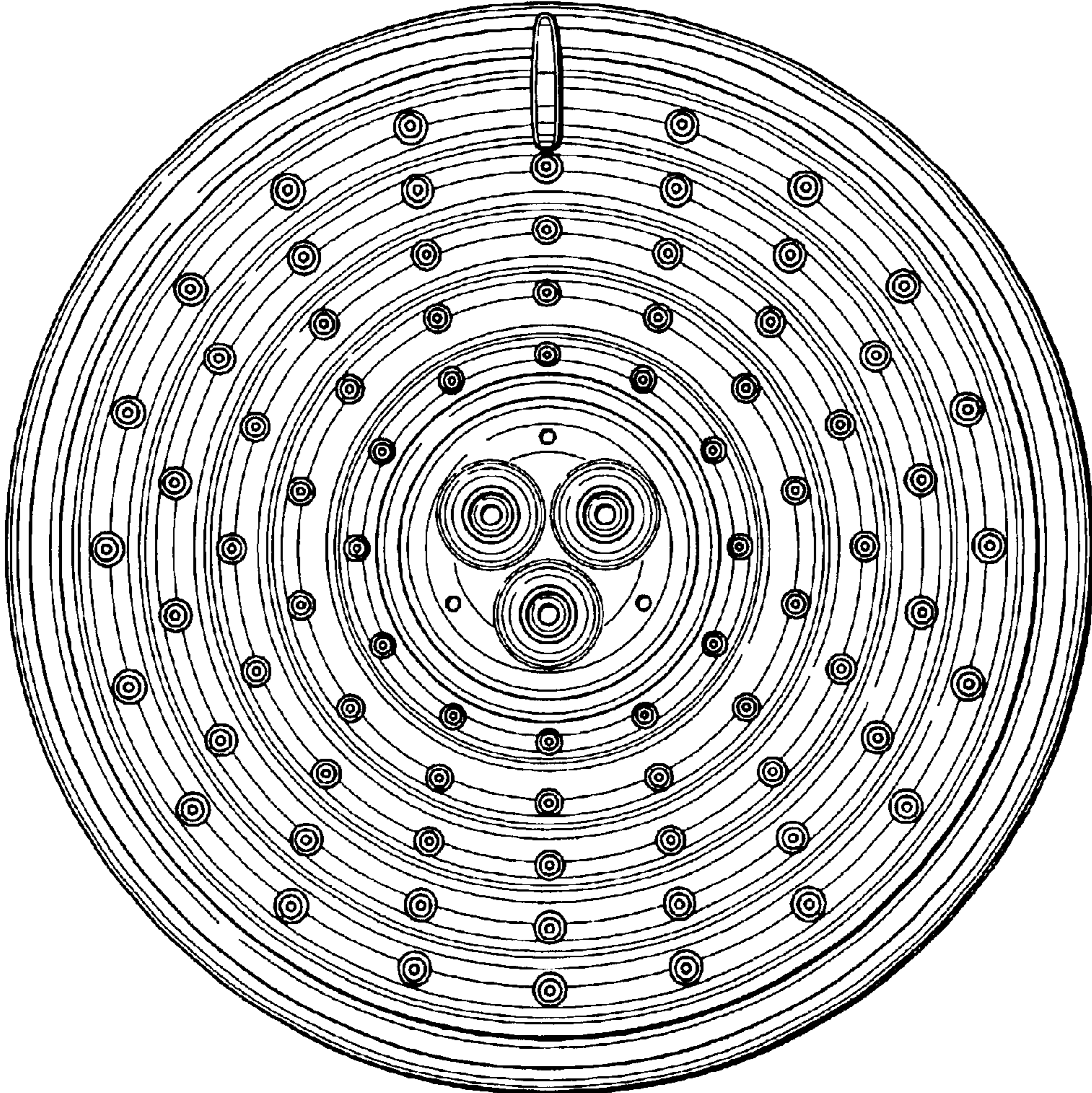
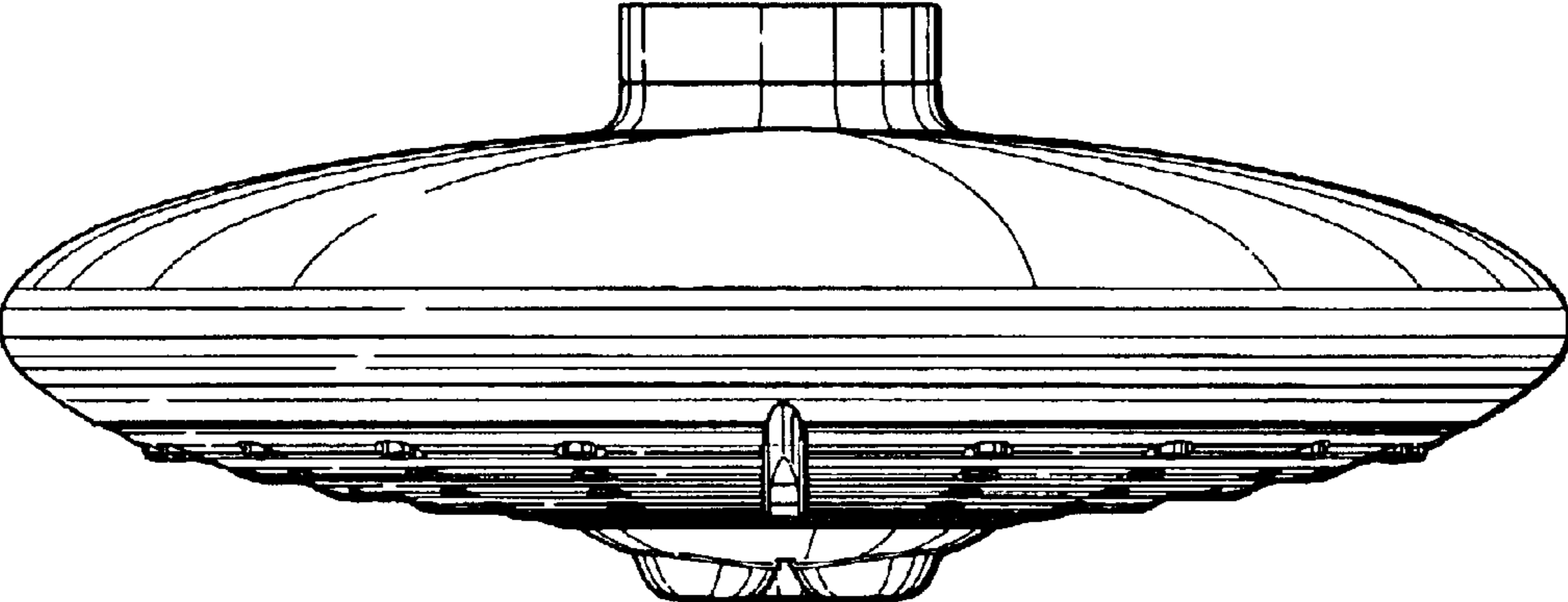

FIG. 4

FIG. 5

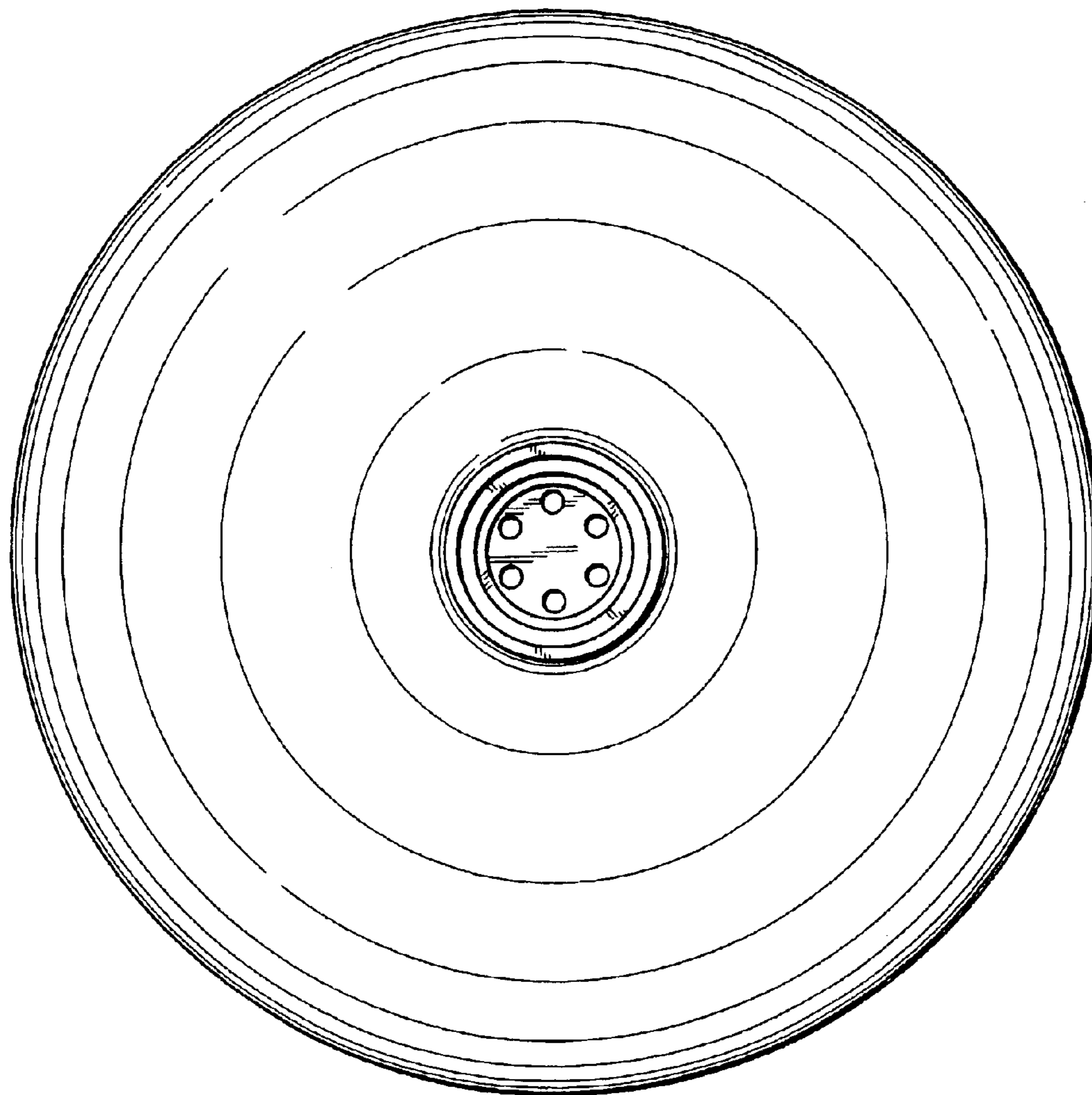
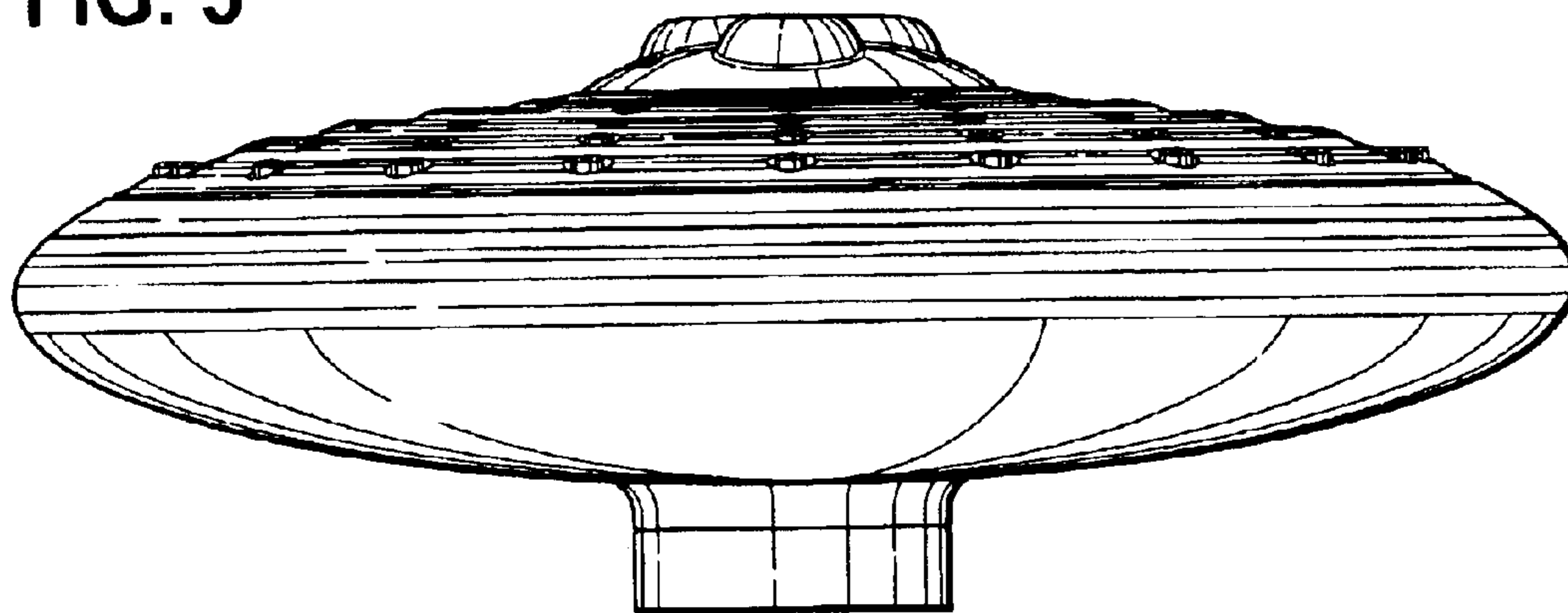

FIG. 6