



US00D491730S1

(12) **United States Design Patent**
Goulet et al.

(10) **Patent No.:** **US D491,730 S**
(45) **Date of Patent:** **** Jun. 22, 2004**

(54) **PAINT BRUSH KEEPER**
(75) Inventors: **Matthew Goulet**, Milwaukee, WI (US);
Dan Schuler, Chicago, IL (US); **Dan Althemer**, Grafton, WI (US)
(73) Assignee: **Newell Operating Company**, Freeport, IL (US)
(**) Term: **14 Years**

5,645,167 A 7/1997 Conrad 206/361
D393,545 S 4/1998 Fernandes D4/199
D401,765 S 12/1998 Soutullo D4/199
D408,151 S 4/1999 Drees et al. D4/199
D411,102 S 6/1999 Planchard D9/305
D425,708 S 5/2000 Drees et al. D4/199
6,059,106 A 5/2000 Baker et al. 206/361
6,390,430 B1 5/2002 Hawley et al. 248/311.2

* cited by examiner

Primary Examiner—Alan P. Douglas
Assistant Examiner—Lavone D. Tabor
(74) *Attorney, Agent, or Firm*—Marshall, Gerstein & Borun LLP

(21) Appl. No.: **29/177,861**
(22) Filed: **Mar. 18, 2003**

(51) **LOC (7) Cl.** **04-99**
(52) **U.S. Cl.** **D4/199; D9/415**
(58) **Field of Search** D4/199; D3/201;
D9/415, 426, 430, 431, 433; 206/15.2,
15.3, 349, 361, 362.3, 362.4, 461-463,
465, 470, 471; 220/4.22-4.24; 229/406;
15/246-247

(57) **CLAIM**

The ornamental design for a “paint brush keeper”, as shown and described.

DESCRIPTION

FIG. 1 is a perspective view of a paint brush keeper showing my new design in a storage position;
FIG. 2 is a rear view thereof;
FIG. 3 is a front view thereof;
FIG. 4 is a right side view thereof;
FIG. 5 is a left side view thereof;
FIG. 6 is a bottom view thereof;
FIG. 7 is a top view thereof; and,
FIG. 8 is a perspective view showing the paint brush keeper in a receiving position.

(56) **References Cited**
U.S. PATENT DOCUMENTS

1,204,531 A 11/1916 Wright
3,800,998 A 4/1974 Gask
4,207,977 A * 6/1980 Kronfeld et al. 206/361
4,423,811 A 1/1984 Knapp 206/362.3
4,865,188 A 9/1989 Custeau 206/209
D335,032 S 4/1993 Durkin, III D4/199
5,363,959 A * 11/1994 Crosby et al. 206/362.4

1 Claim, 4 Drawing Sheets

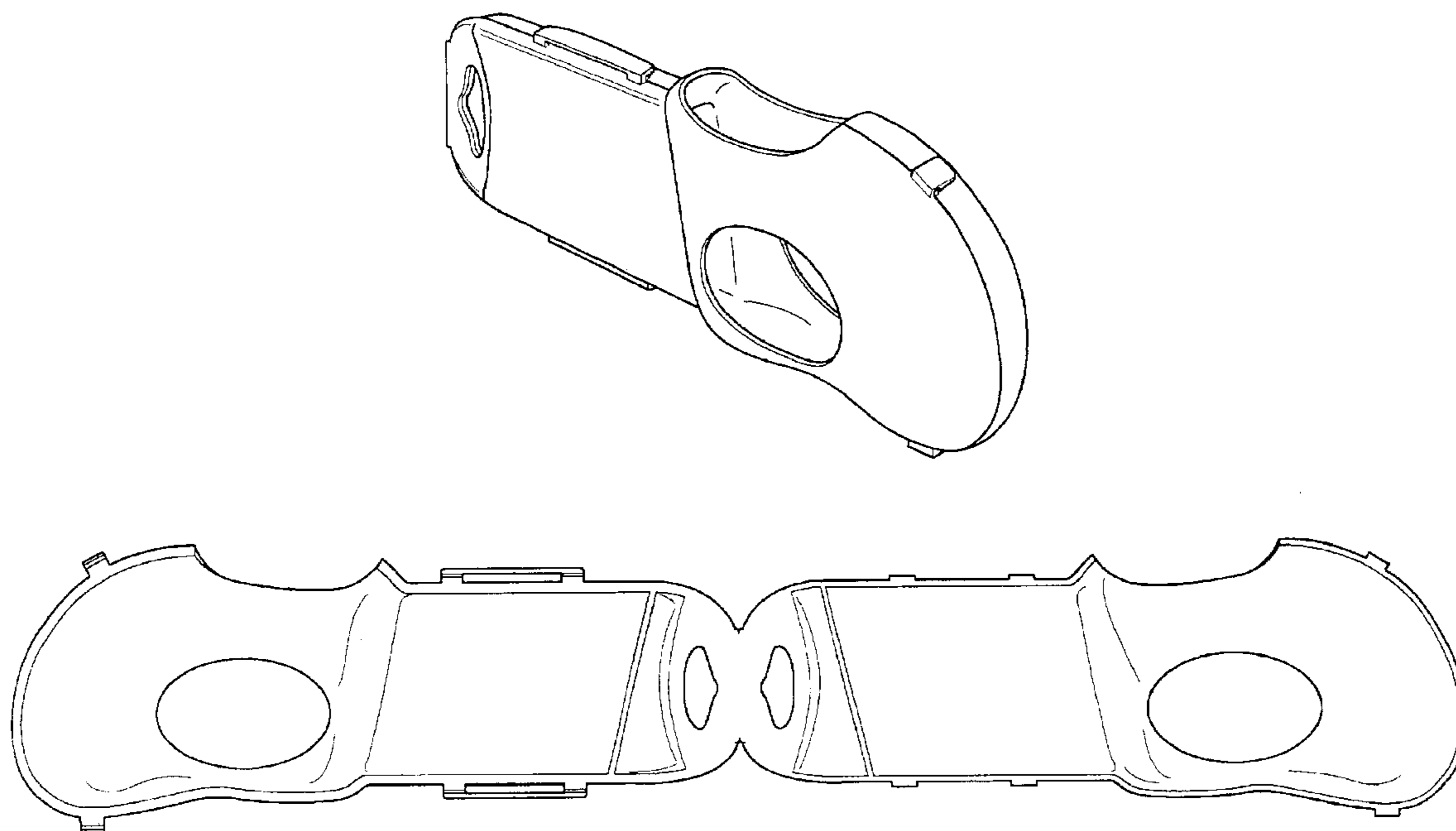

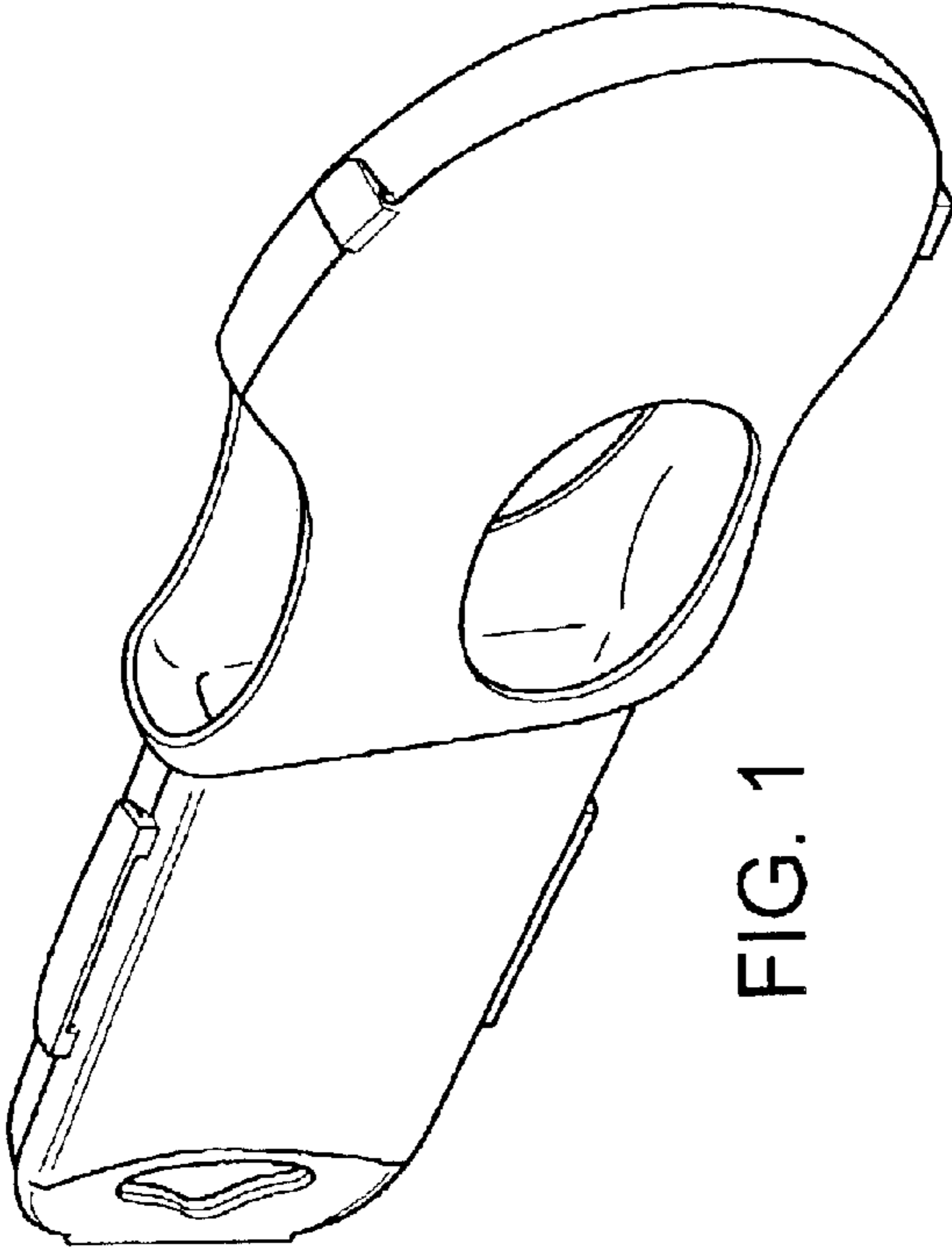

FIG. 1

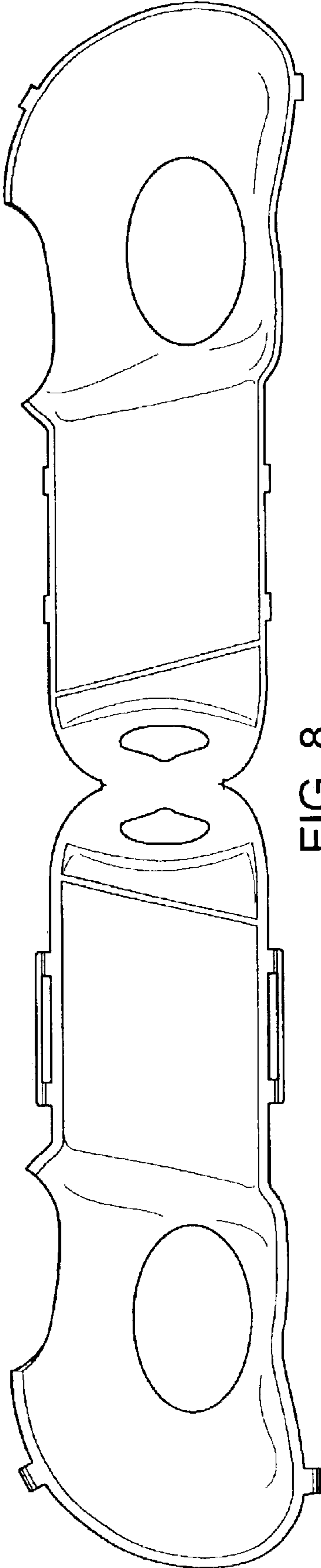

FIG. 8

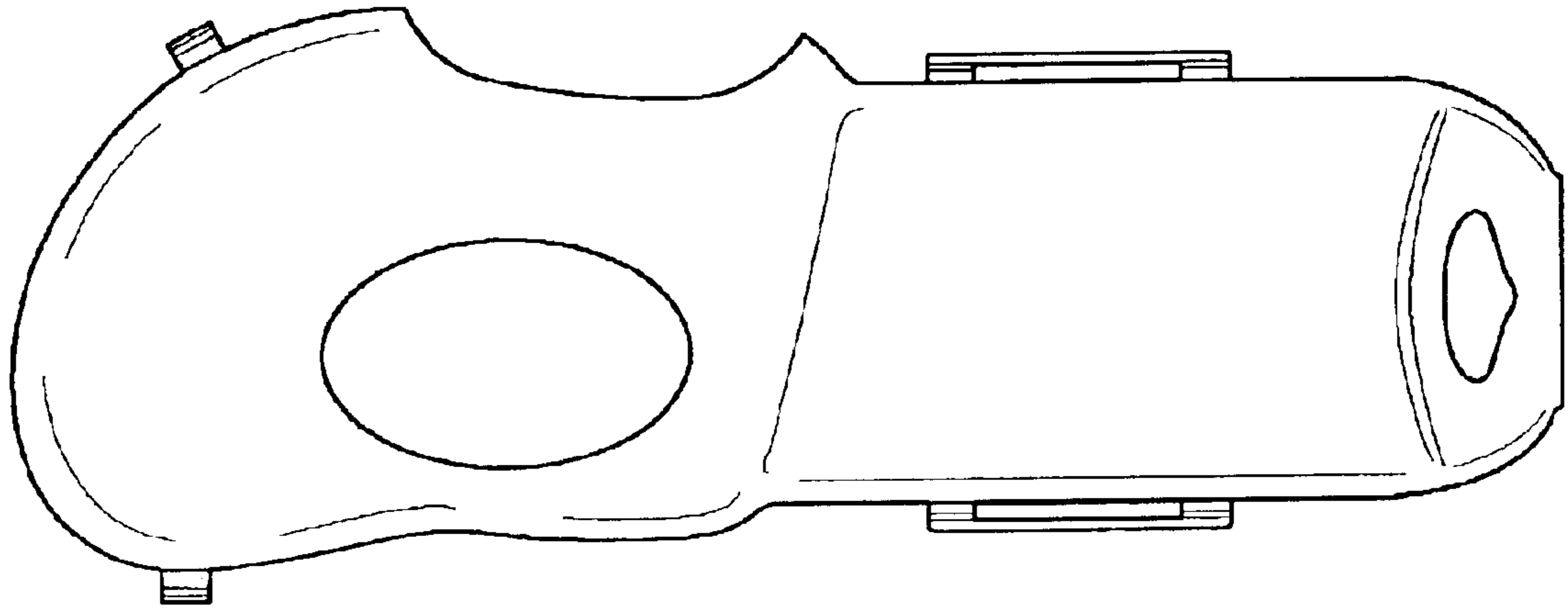

FIG. 2

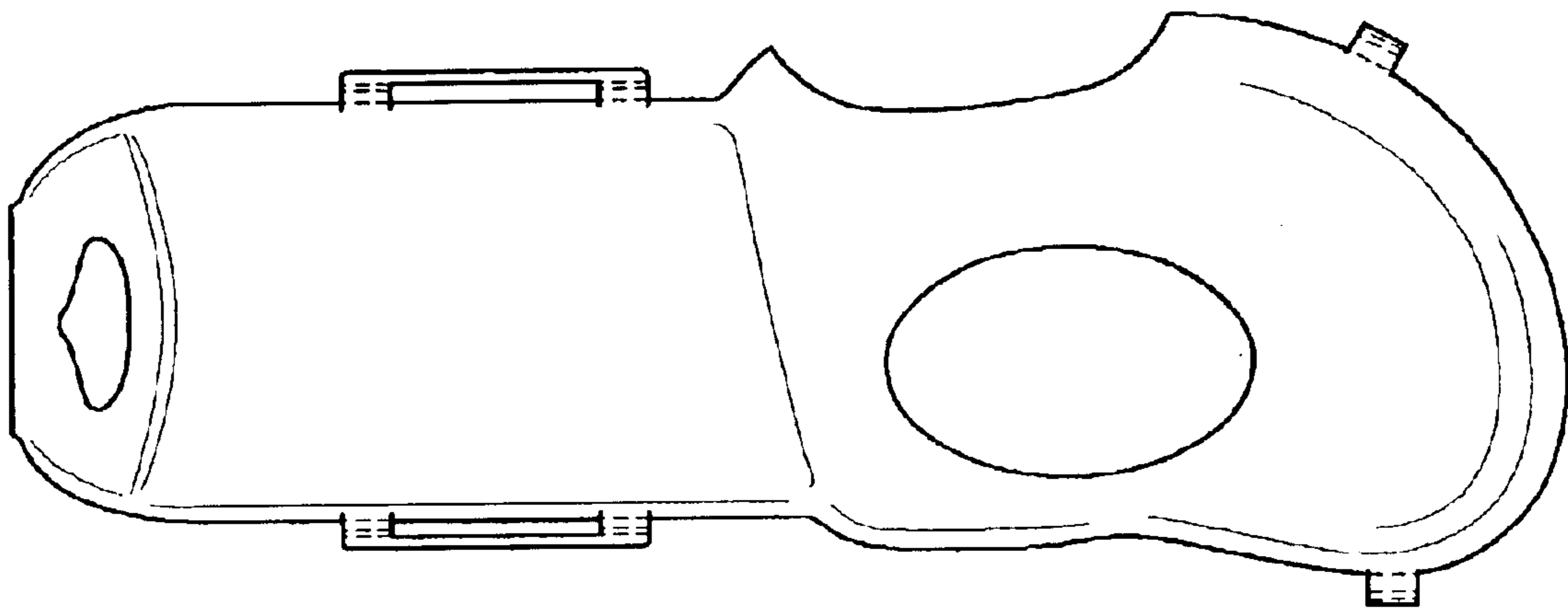

FIG. 3

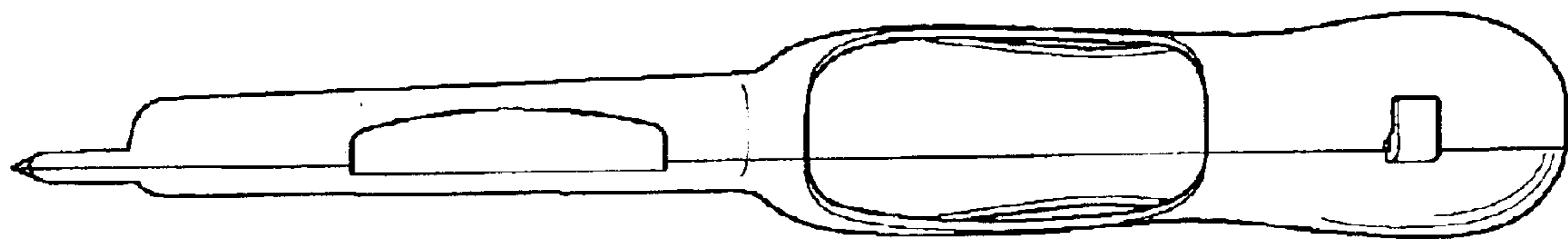

FIG. 4

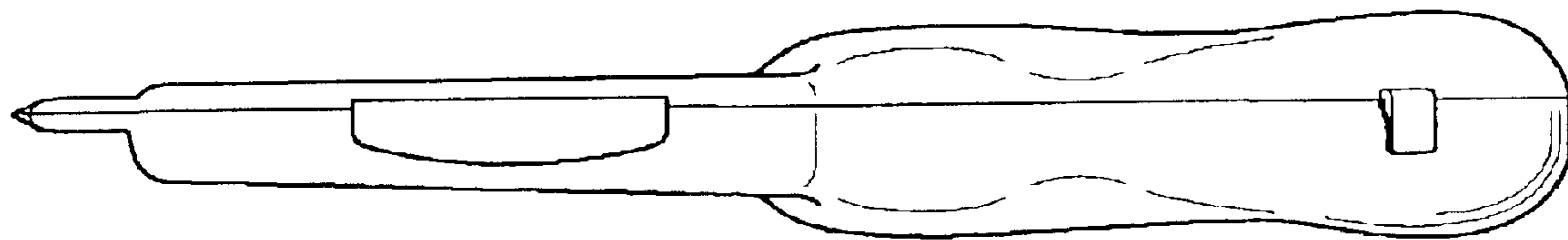

FIG. 5

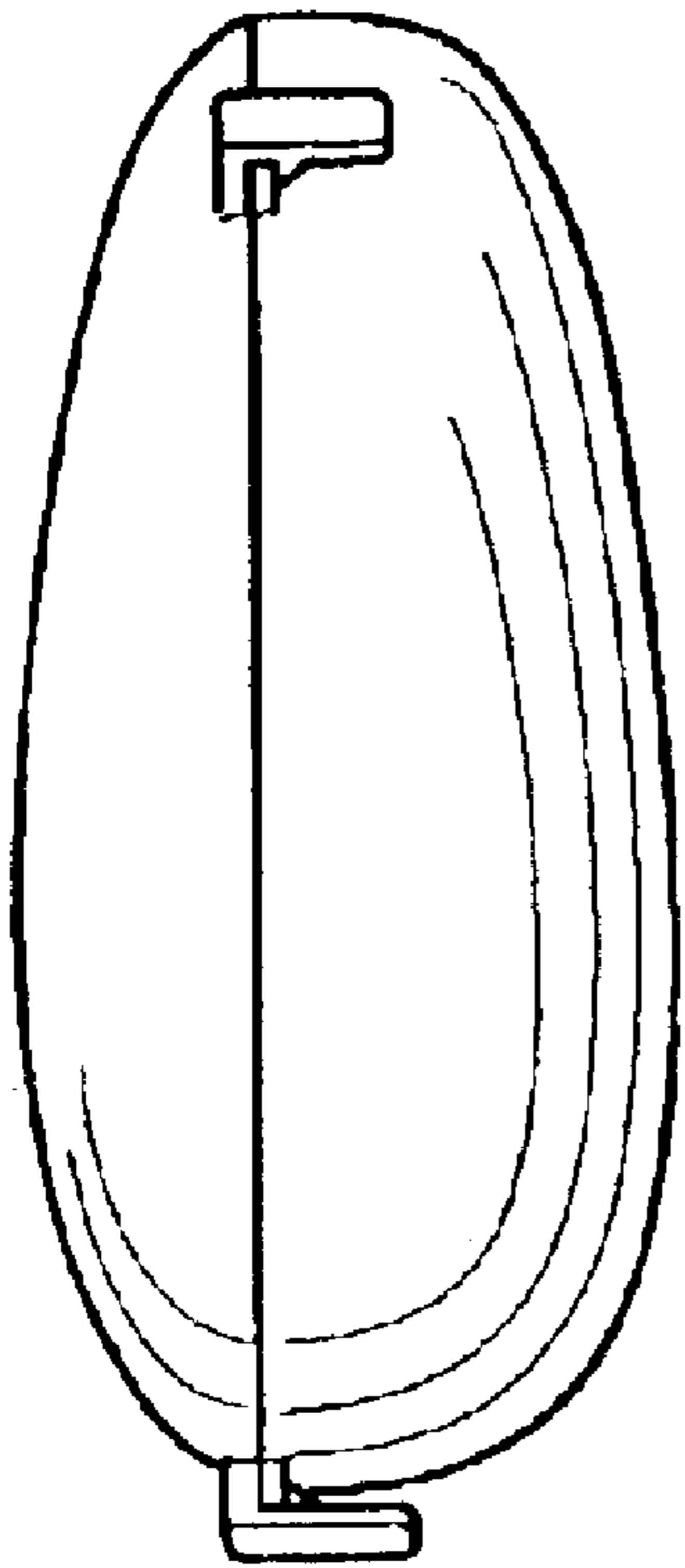

FIG. 6

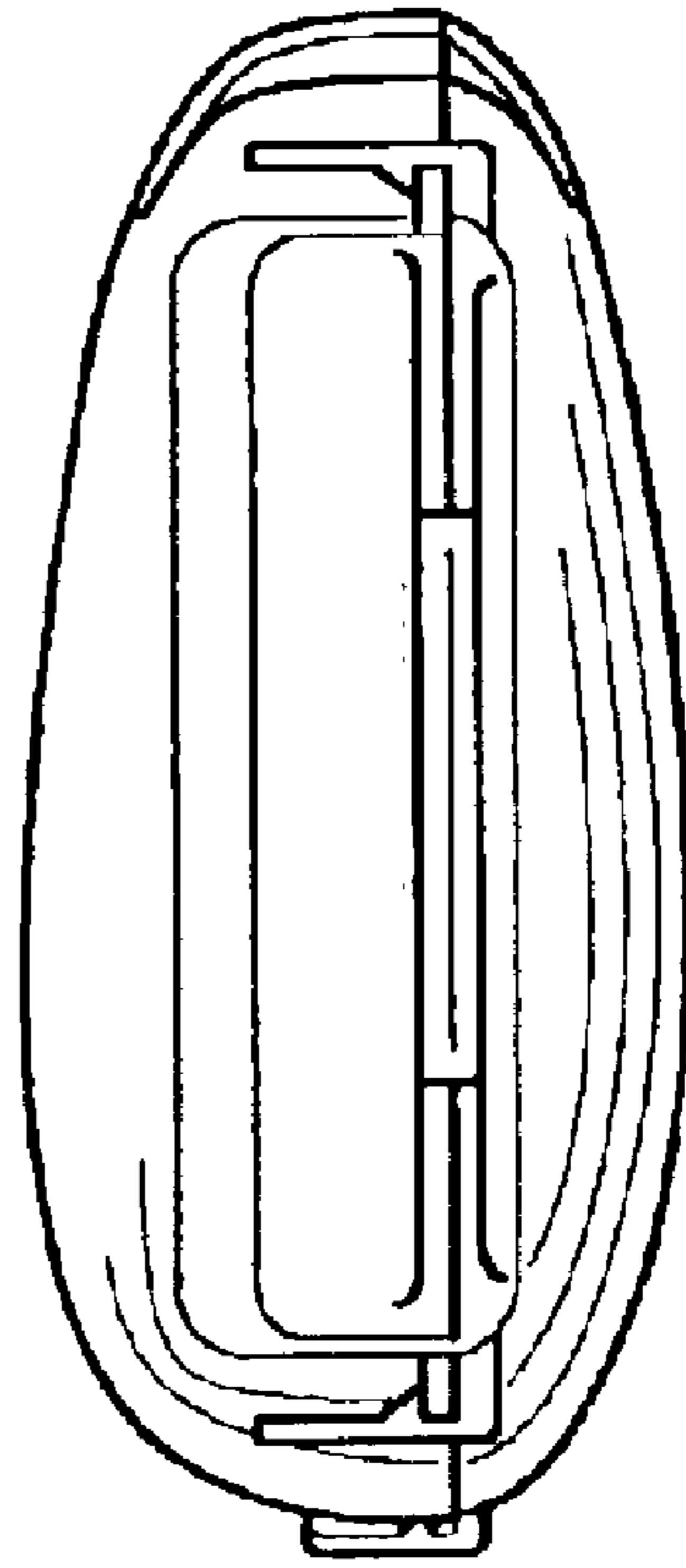

FIG. 7