



US00D491551S

(12) **United States Design Patent**  
**Matsui et al.**

(10) **Patent No.:** **US D491,551 S**

(45) **Date of Patent:** **\*\* Jun. 15, 2004**

(54) **INTERPHONE**

JP 1012221 3/1998

(75) Inventors: **Hiroshi Matsui**, Nagoya (JP); **Toshio Hotta**, Tokai (JP)

**OTHER PUBLICATIONS**

Aiphone Kommunikations-Systeme 2002, Extract from Catalogue, pp. 30-31.

(73) Assignee: **Aiphone Co., Ltd.**, Aichi-ken (JP)

\* cited by examiner

(\*\*) Term: **14 Years**

*Primary Examiner*—Nanda Bondade

(21) Appl. No.: **29/173,554**

(74) *Attorney, Agent, or Firm*—Birch, Stewart, Kolasch & Birch, LLP

(22) Filed: **Jan. 2, 2003**

(30) **Foreign Application Priority Data**

Jul. 5, 2002 (JP) ..... 2002-018172  
Jul. 5, 2002 (JP) ..... 2002-018173

(57) **CLAIM**

The ornamental design for an interphone, as shown and described.

(51) **LOC (7) Cl.** ..... **14-03**

(52) **U.S. Cl.** ..... **D14/159**

(58) **Field of Search** ..... D10/104, 106;  
D14/142, 146, 155, 158, 159, 243, 299;  
340/539, 571-573; 342/419, 450; 379/167.05,  
167.14

**DESCRIPTION**

FIG. 1 is a perspective view of an interphone showing our new design;  
FIG. 2 is a front elevational view thereof;  
FIG. 3 is a rear elevational view thereof;  
FIG. 4 is a left side elevational view thereof;  
FIG. 5 is a right side elevational view thereof;  
FIG. 6 is a top plan view thereof;  
FIG. 7 is a bottom plan view thereof;  
FIG. 8 is a perspective view illustrating a second embodiment of the present invention;  
FIG. 9 is a front elevational view thereof;  
FIG. 10 is a rear elevational view thereof;  
FIG. 11 is a left side elevational view thereof;  
FIG. 12 is a right side elevational view thereof;  
FIG. 13 is a top plan view thereof; and,  
FIG. 14 is a bottom plan view thereof.

(56) **References Cited**

**U.S. PATENT DOCUMENTS**

D283,130 S \* 3/1986 Boening ..... D14/159  
4,809,320 A \* 2/1989 Hawkins et al. .... 379/167.05  
D313,592 S \* 1/1991 Morooka ..... D14/159  
D321,686 S \* 11/1991 Plozner ..... D14/159  
D466,491 S \* 12/2002 Matsui et al. .... D14/159  
D466,882 S \* 12/2002 Matsui et al. .... D14/159

**FOREIGN PATENT DOCUMENTS**

JP 749954 8/1988

**1 Claim, 8 Drawing Sheets**

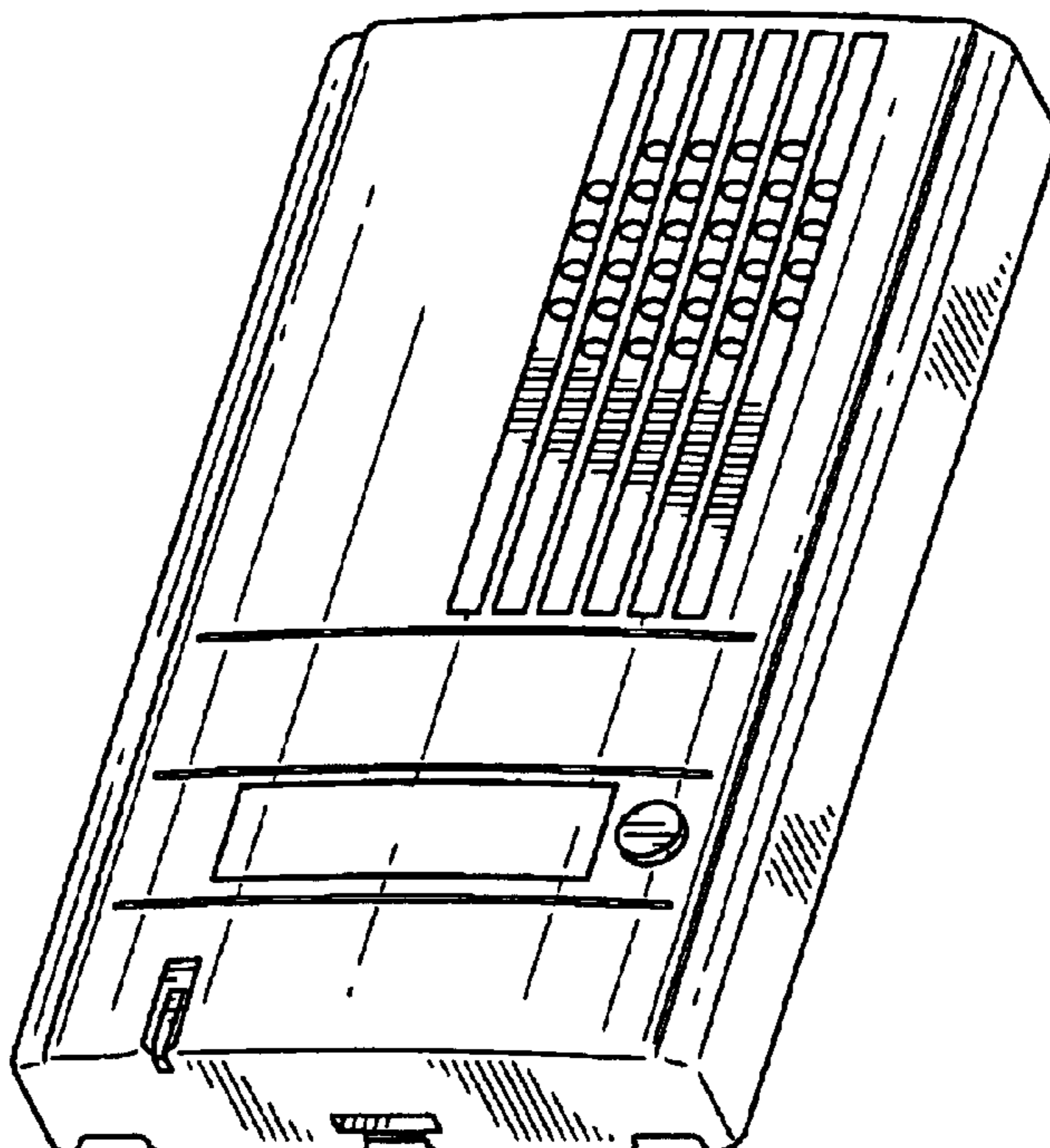

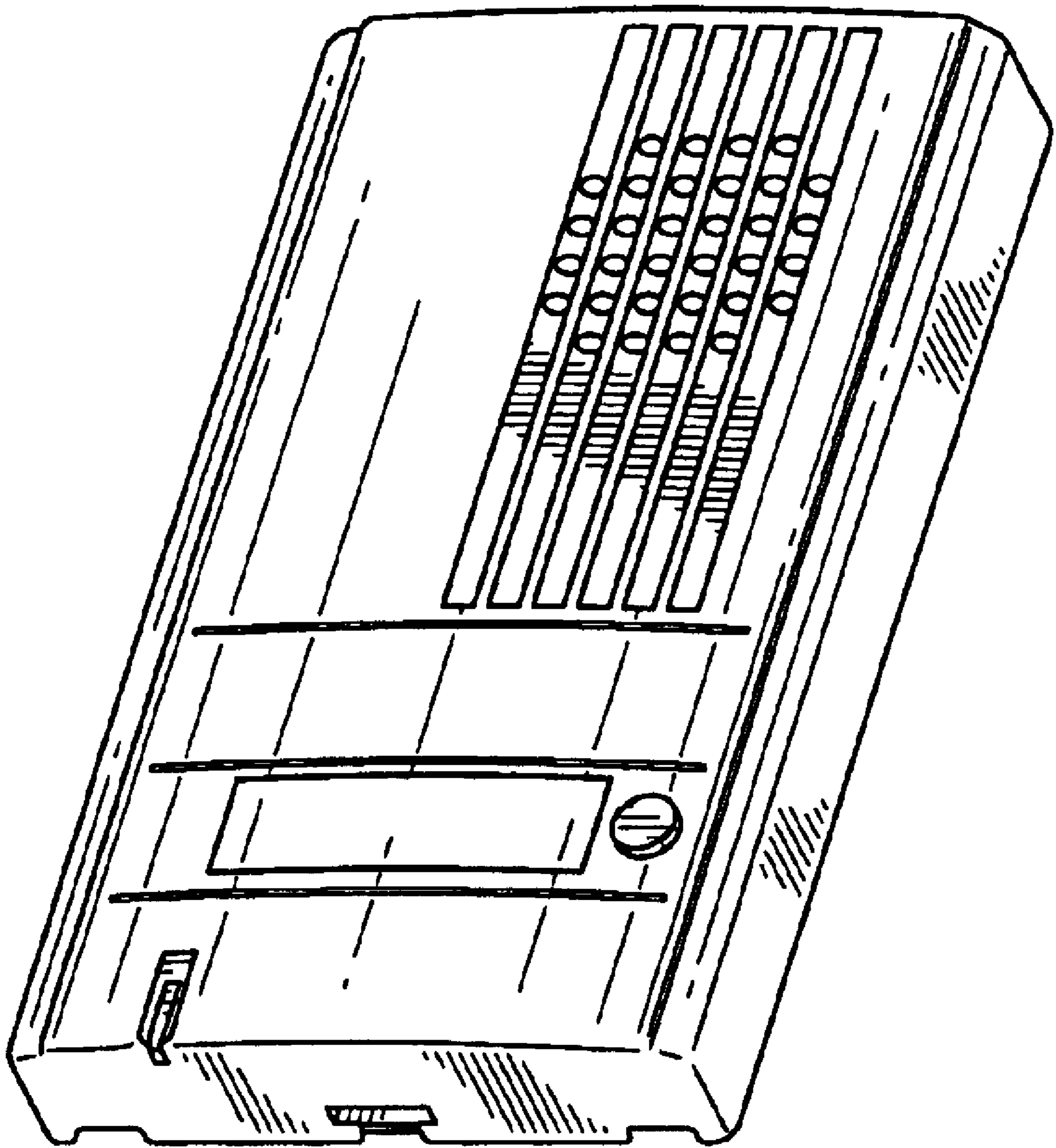

FIG. 1

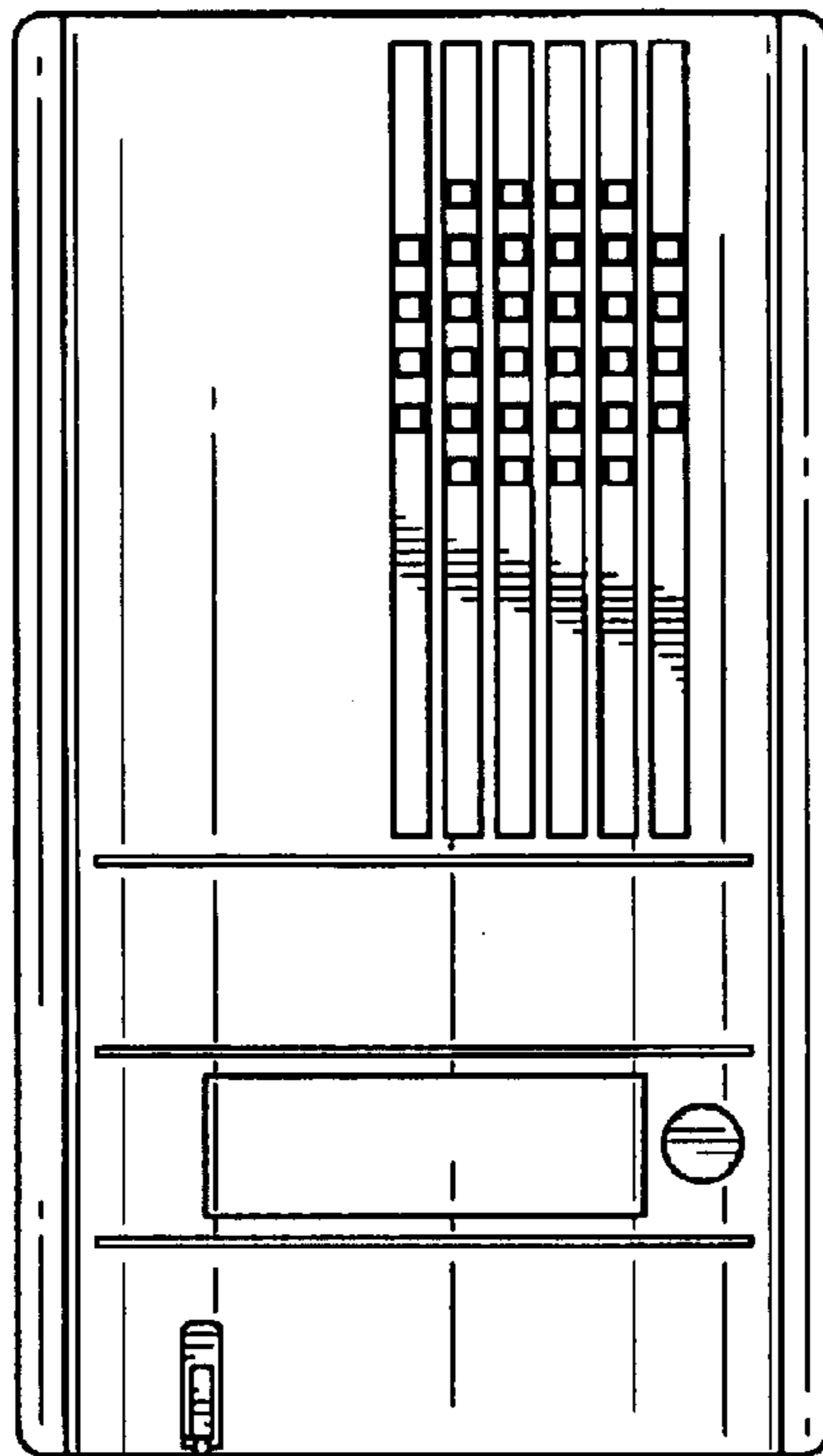

FIG. 2

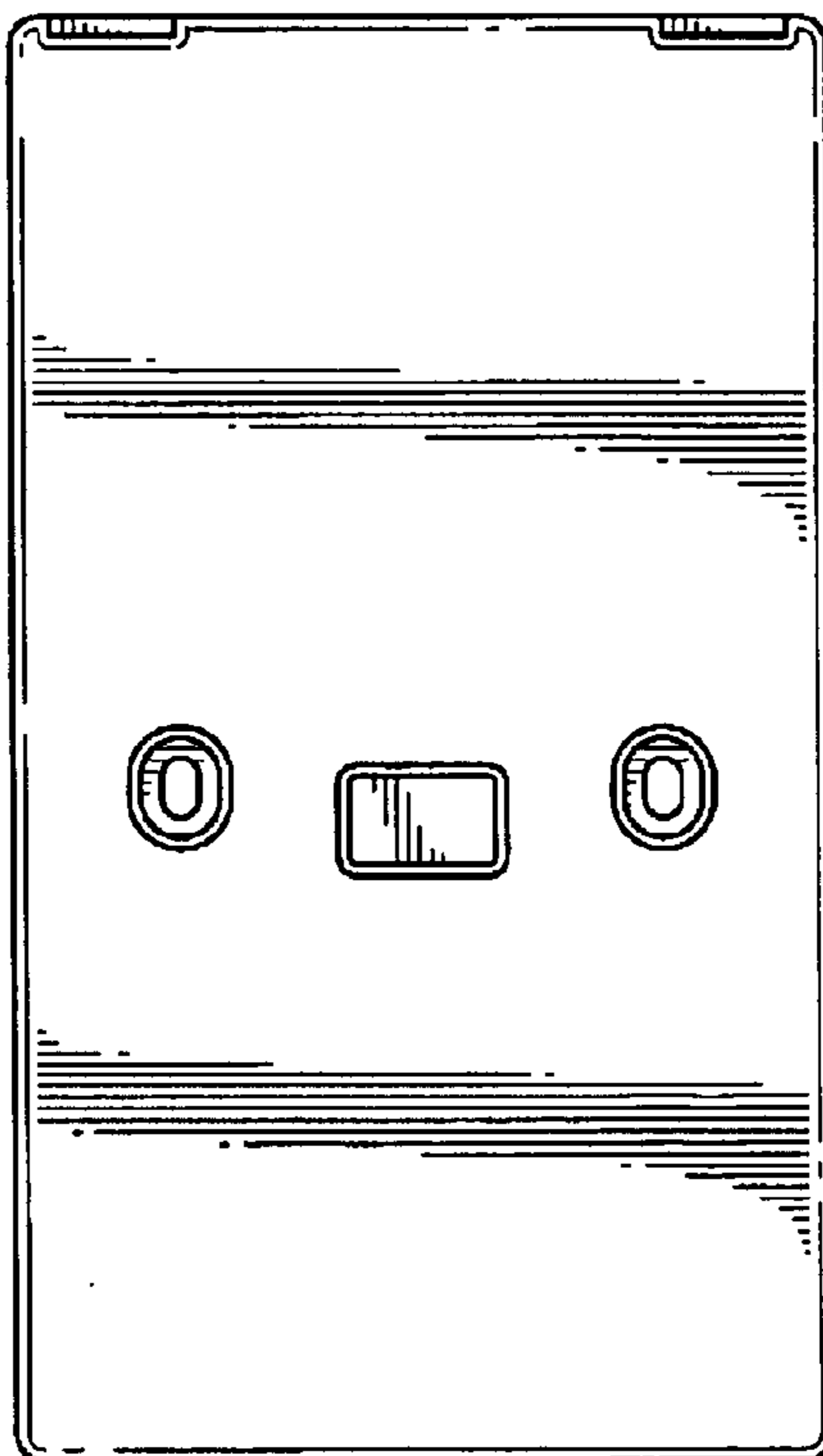

FIG. 3

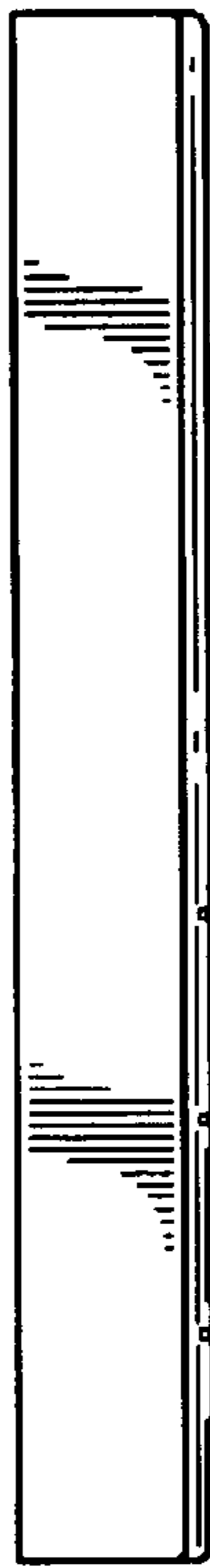

FIG. 4

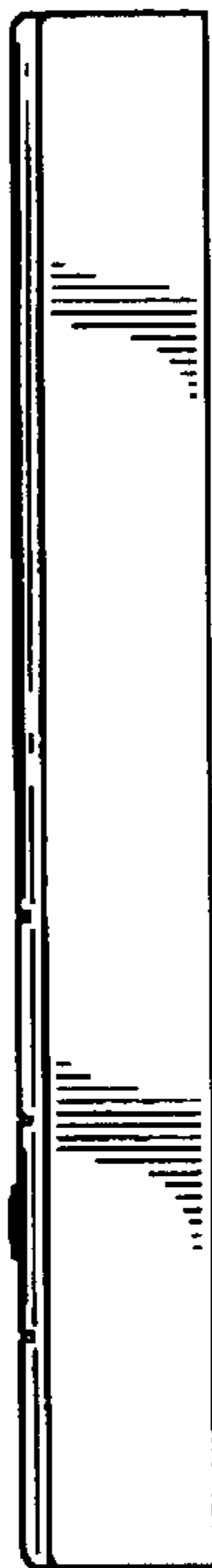

FIG. 5

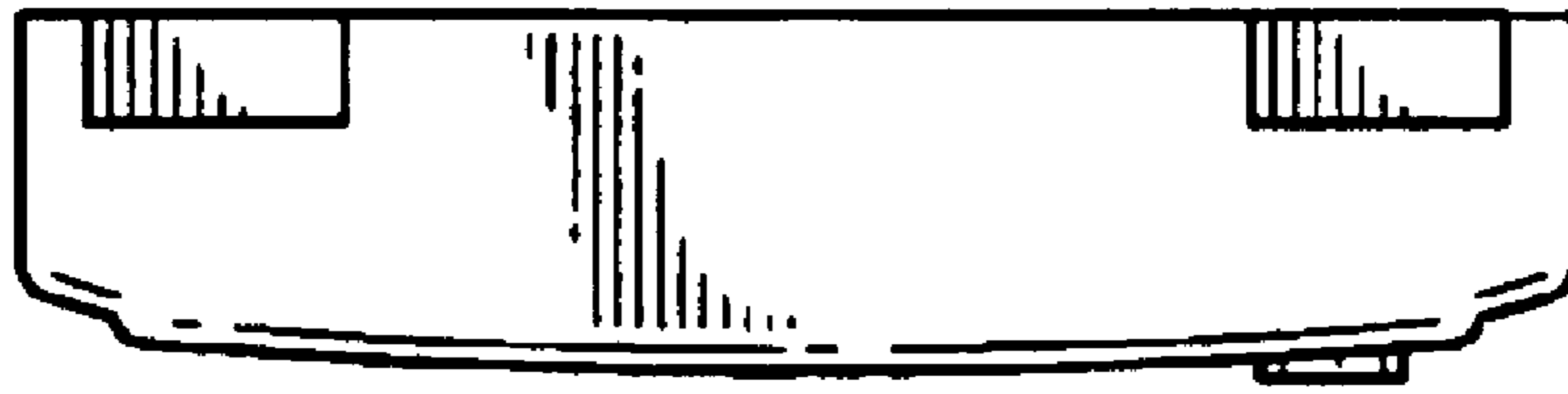

FIG. 6

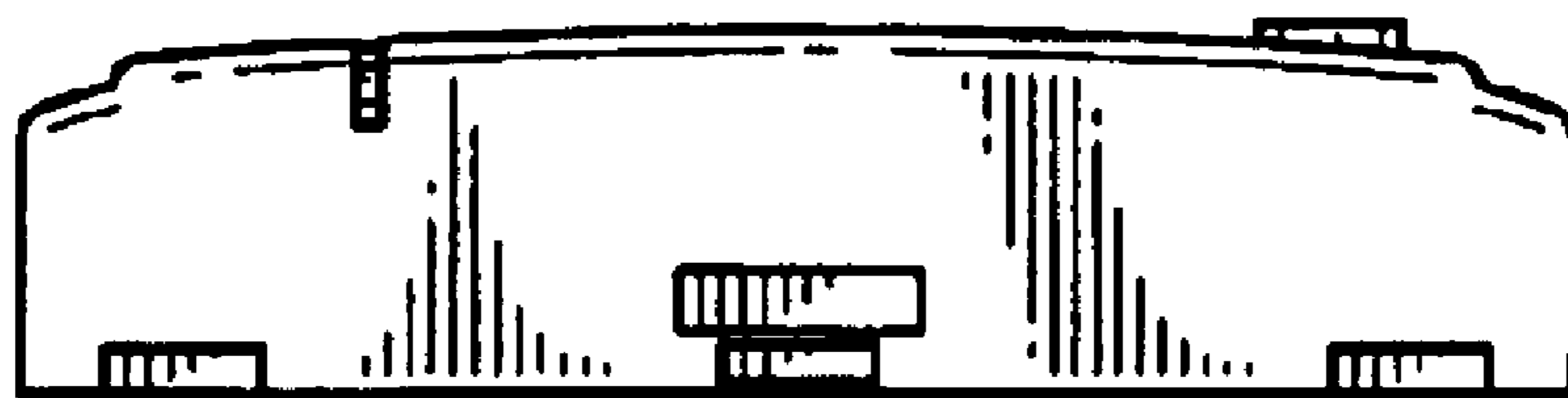

FIG. 7

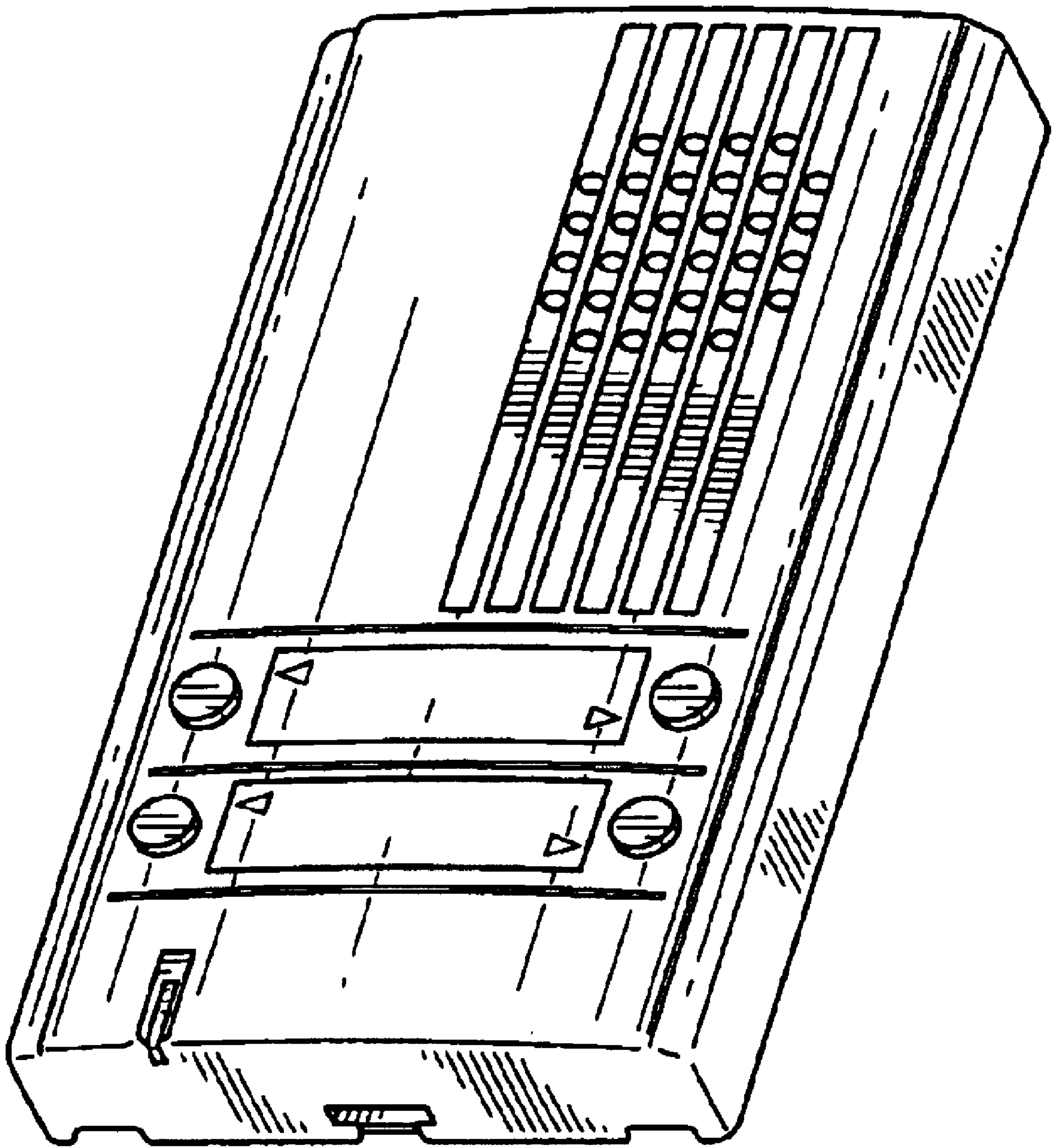

FIG. 8

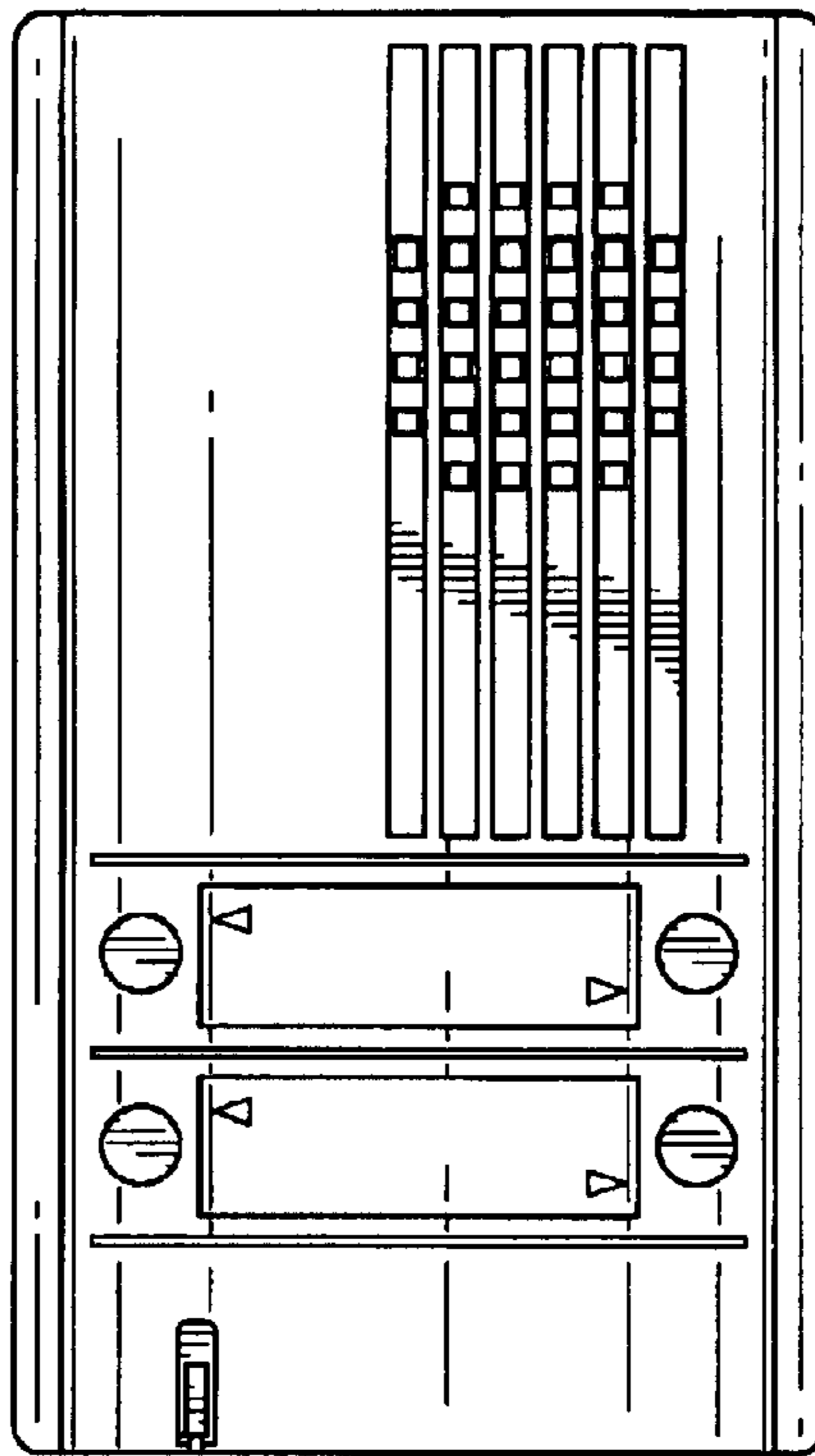

FIG. 9

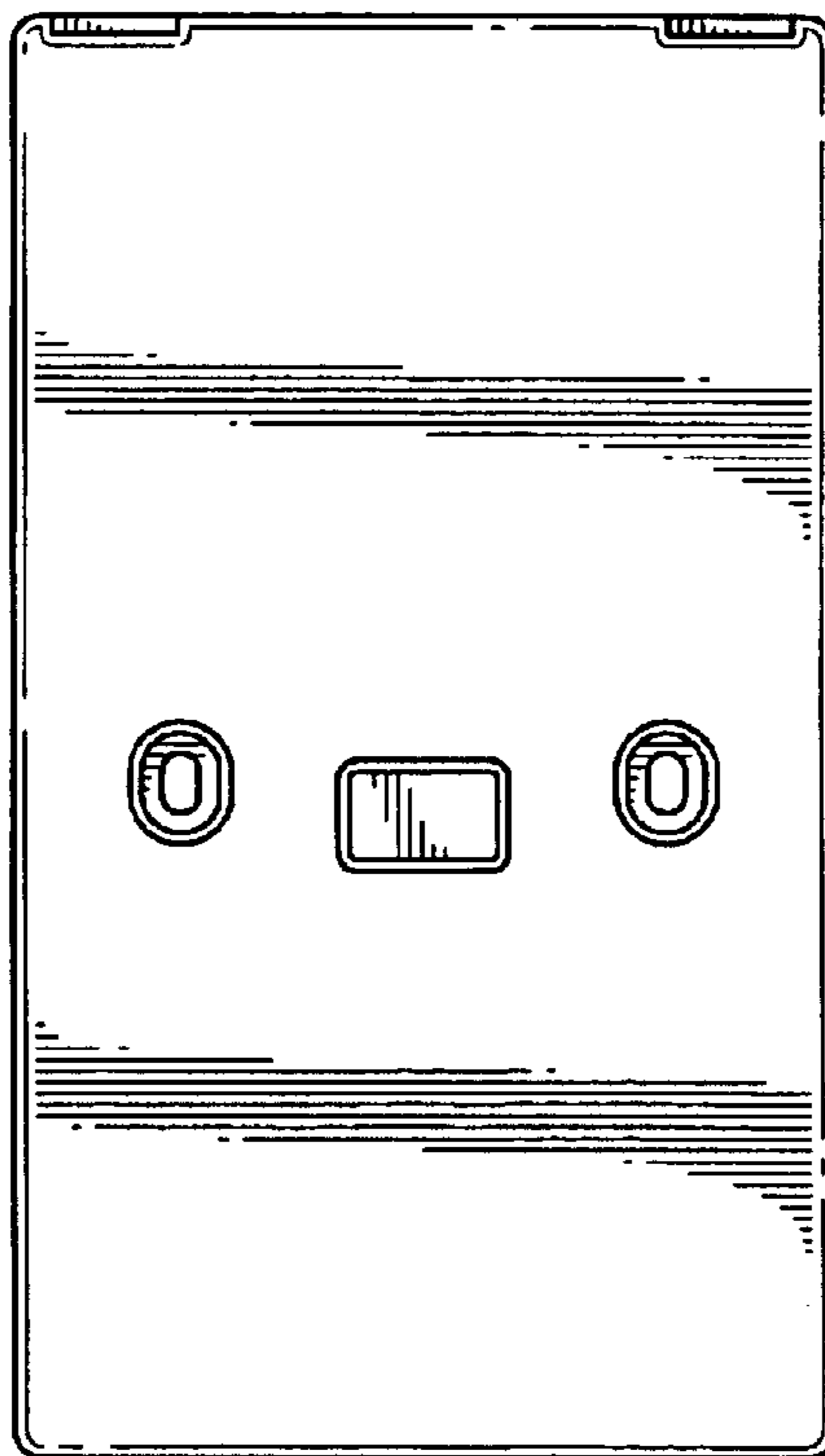

FIG. 10

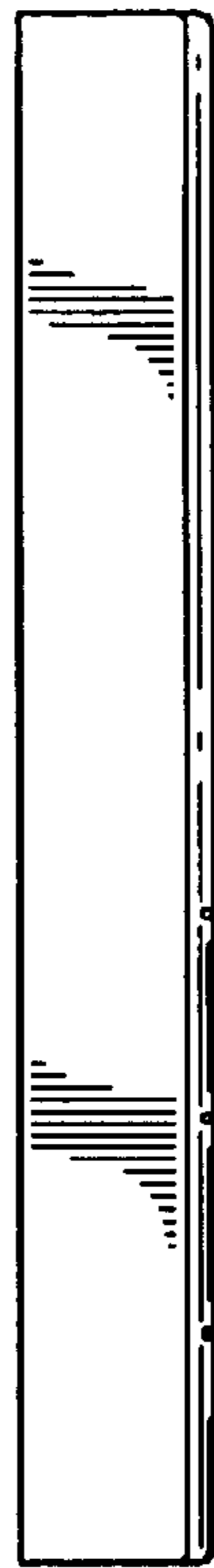

FIG. 11

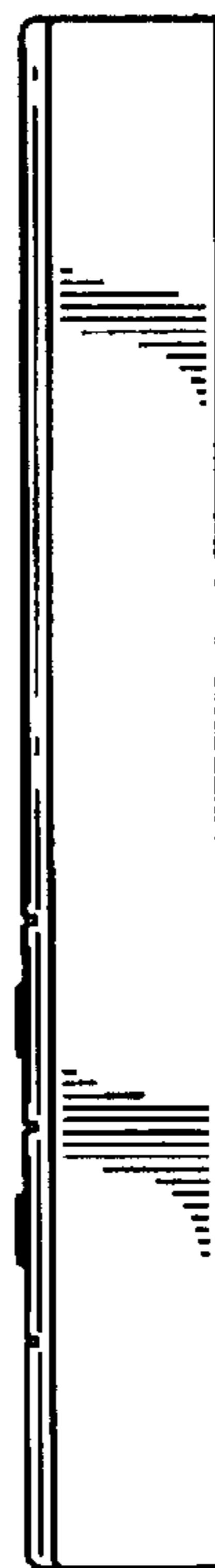

FIG. 12



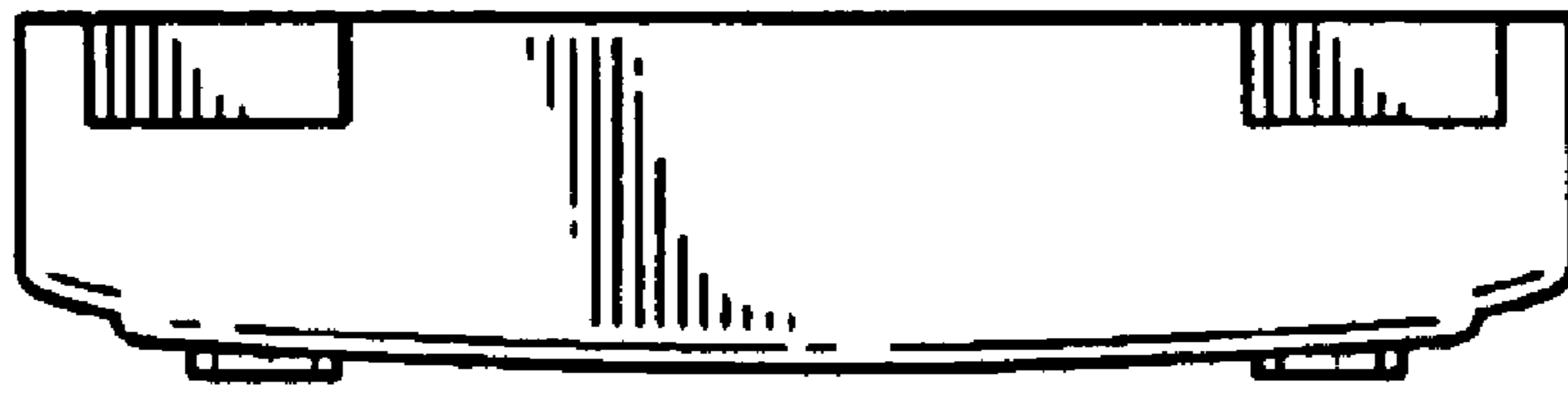

FIG. 13

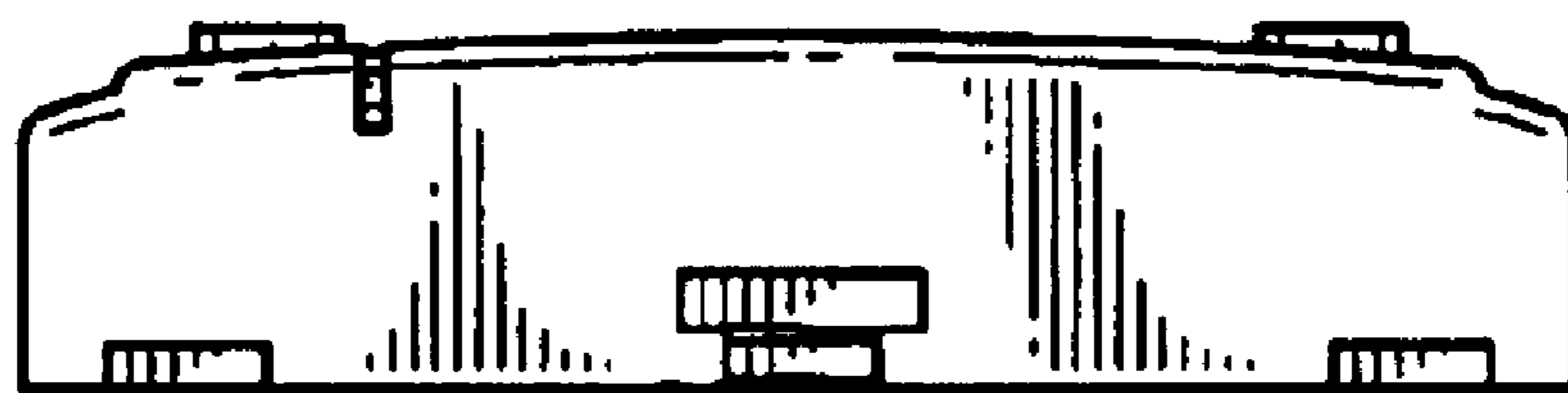

FIG. 14