



US00D491538S

(12) **United States Design Patent**
Ishida

(10) **Patent No.:** **US D491,538 S**

(45) **Date of Patent:** **** Jun. 15, 2004**

(54) **LIGHT EMITTING DIODE**

(75) Inventor: **Masashi Ishida**, Anan (JP)

(73) Assignee: **Nichia Corporation**, Anan (JP)

(**) Term: **14 Years**

(21) Appl. No.: **29/159,905**

(22) Filed: **May 1, 2002**

(30) **Foreign Application Priority Data**

Nov. 2, 2001	(JP)	2001-032437
Nov. 2, 2001	(JP)	2001-032438
Nov. 2, 2001	(JP)	2001-032439
Nov. 2, 2001	(JP)	2001-032440
Nov. 2, 2001	(JP)	2001-032441

(51) **LOC (7) Cl.** **13-03**

(52) **U.S. Cl.** **D13/182**

(58) **Field of Search** D10/104, 106,
D10/121; D13/180, 182; D26/2, 37; 257/88,
89, 93-96; 313/500, 290, 499; 315/161;
345/39, 46, 82, 84; 361/820; 362/800

(56) **References Cited**

U.S. PATENT DOCUMENTS

4,152,624	A	*	5/1979	Knaebel	313/499
4,959,761	A	*	9/1990	Critelli et al.	362/226
D312,979	S	*	12/1990	Oesterheld et al.	D10/114
D314,919	S	*	2/1991	Villar	D10/46
5,045,895	A	*	9/1991	Yoshida et al.	257/91
5,226,053	A	*	7/1993	Cho et al.	372/45
RE36,614	E	*	3/2000	Lumbard et al.	313/500
D432,095	S	*	10/2000	Seeger et al.	D13/182
D437,798	S	*	2/2001	Kiba et al.	D10/104
D439,351	S	*	3/2001	Kiba et al.	D26/37
6,315,432	B1	*	11/2001	Kuo	362/287
D453,745	S	*	2/2002	Suenaga	D13/180

FOREIGN PATENT DOCUMENTS

JP D984224 S 7/1997

OTHER PUBLICATIONS

Surface Mount Type LED—Light Emitting Diode, Product Guide, Jan. 2001, 6 pages, Cat. No. 01033K, Nichia Corporation, Japan.

* cited by examiner

Primary Examiner—Ted Shooman

Assistant Examiner—Selina Sikder

(74) *Attorney, Agent, or Firm*—Smith Patent Office

(57) **CLAIM**

I claim the ornamental design for a light emitting diode, as shown and described.

DESCRIPTION

FIG. 1 is a perspective view of a light emitting diode showing my new design;
 FIG. 2 is a plan view of the light emitting diode according to the embodiment of FIG. 1;
 FIG. 3 is a left view of the light emitting diode according to the embodiment of FIG. 1;
 FIG. 4 is a front elevational view of the light emitting diode according to the embodiment of FIG. 1;
 FIG. 5 is a right view of the light emitting diode according to the embodiment of FIG. 1;
 FIG. 6 is a bottom plan of the light emitting diode according to the embodiment of FIG. 1;
 FIG. 7 is a rear view of the same light emitting diode as showing in FIG. 1;
 FIG. 8 is a plan view of the light emitting diode according to another embodiment of my new design;
 FIG. 9 is a left view of the light emitting diode according to the embodiment of FIG. 8;
 FIG. 10 is a front elevational view of the light emitting diode according to the embodiment of FIG. 8;
 FIG. 11 is a right view of the light emitting diode according to the embodiment of FIG. 8;
 FIG. 12 is a bottom plan view of the light emitting diode according to the embodiment of FIG. 8; and,
 FIG. 13 is a rear view of the light emitting diode according to the embodiment of FIG. 8.

1 Claim, 3 Drawing Sheets

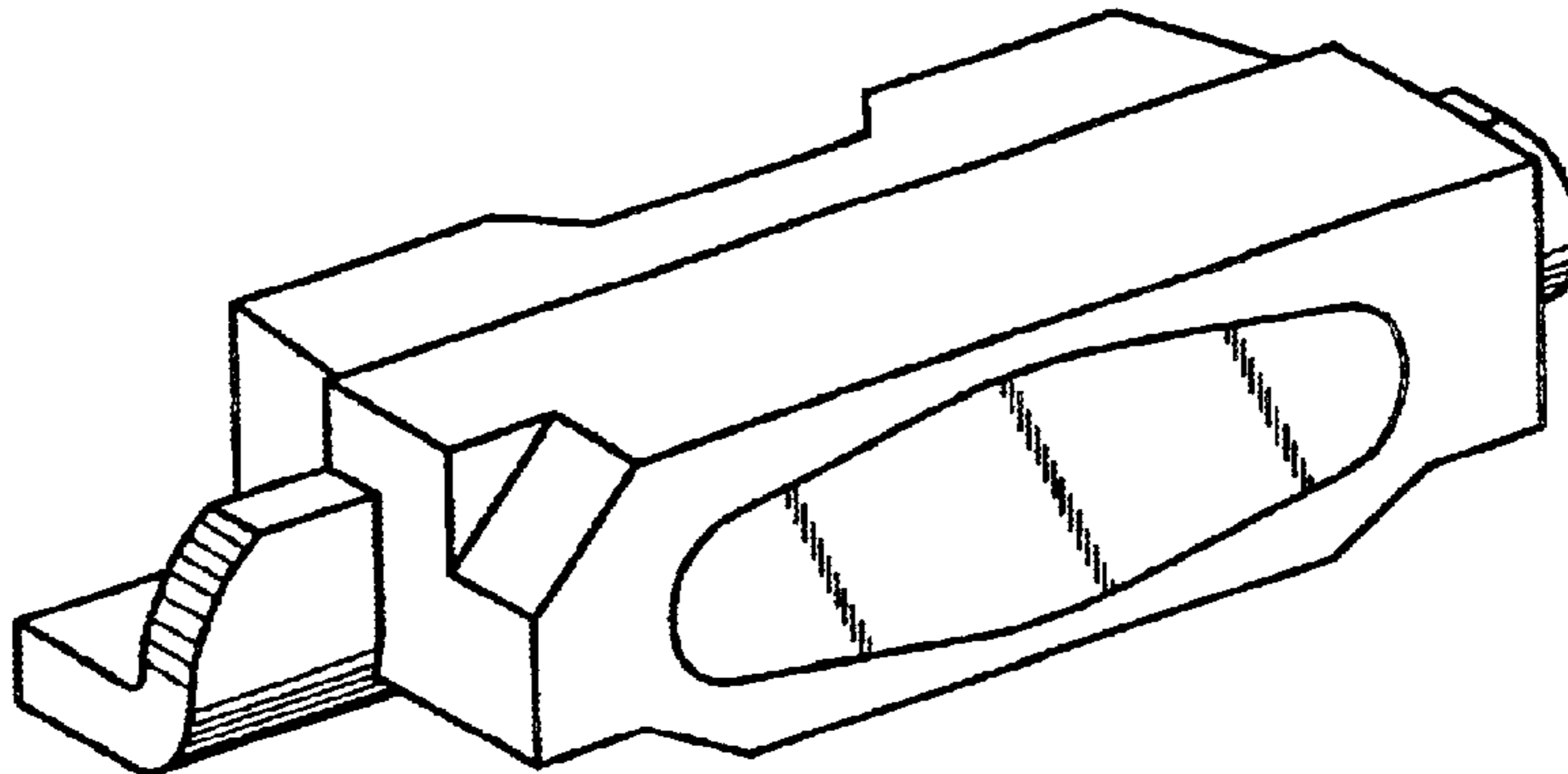

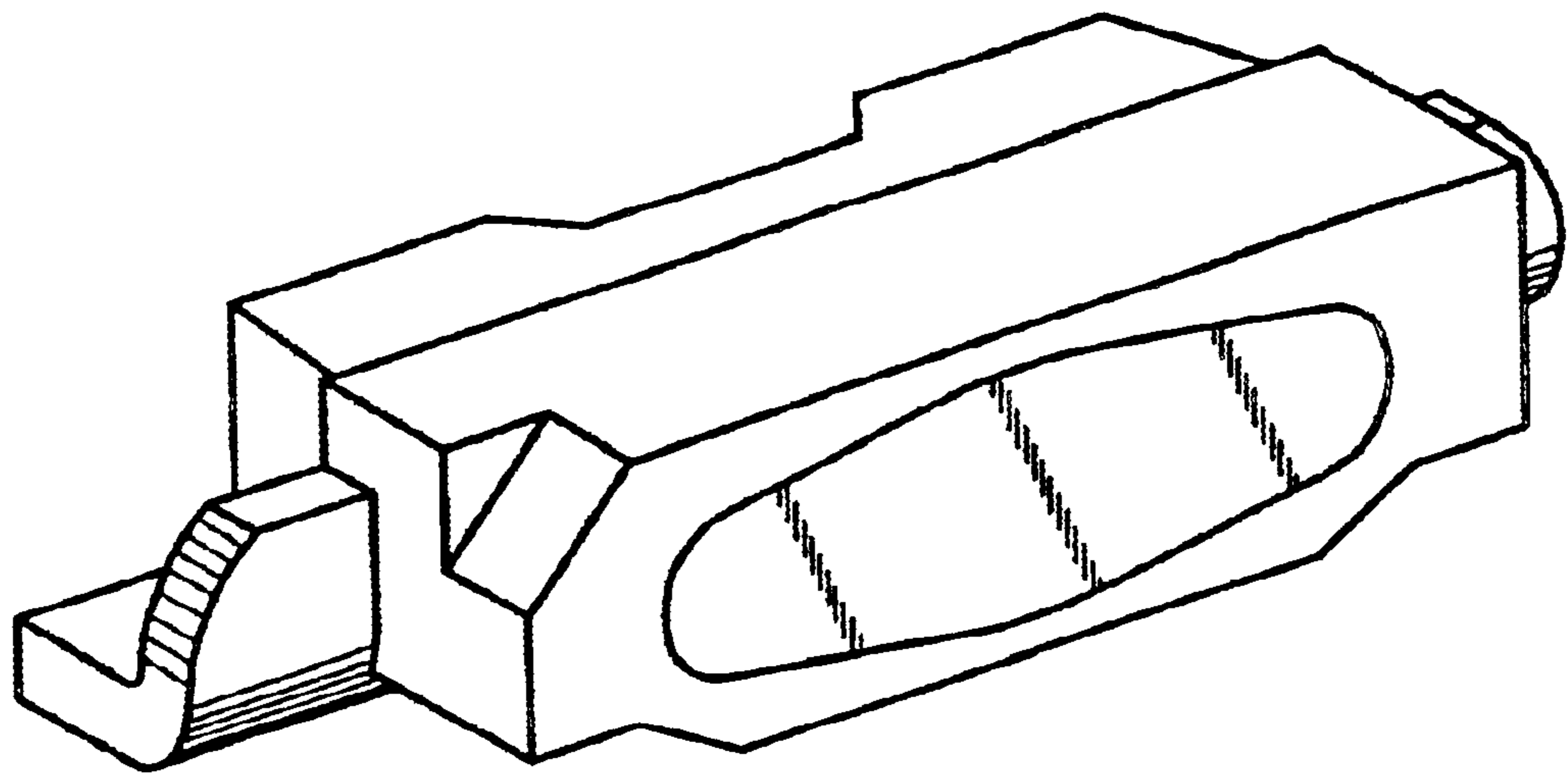

FIG. 1

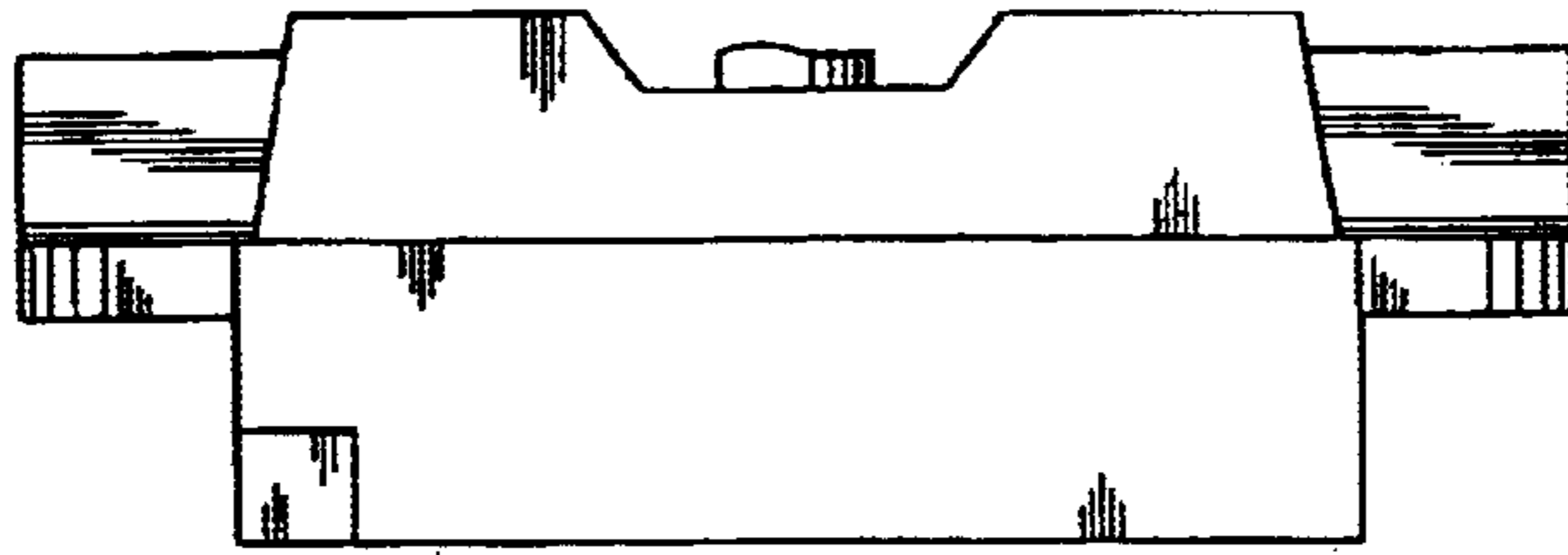

FIG. 2

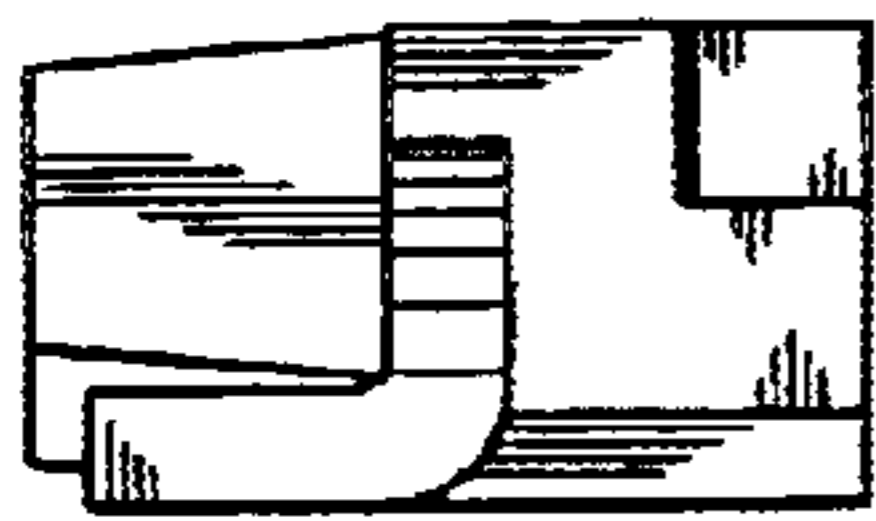

FIG. 3

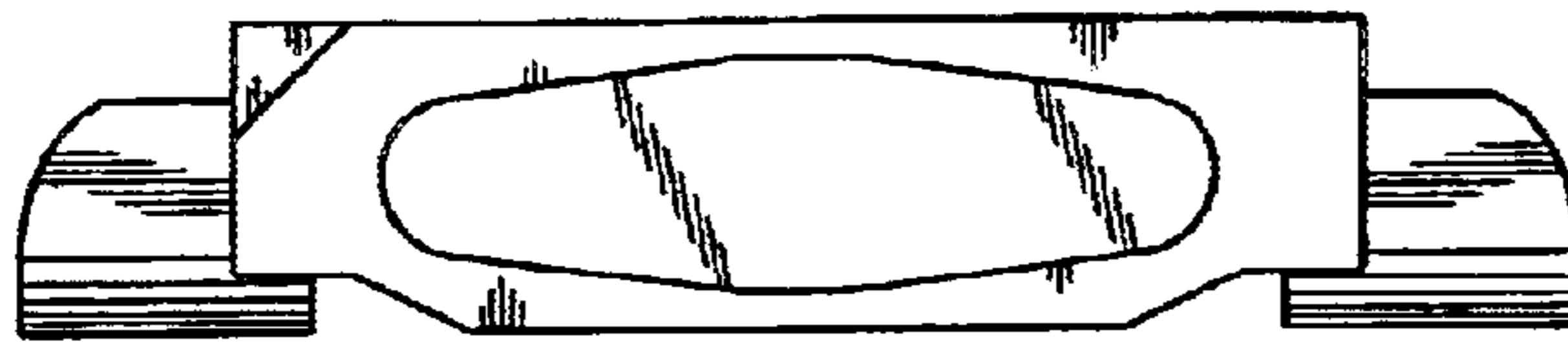

FIG. 4

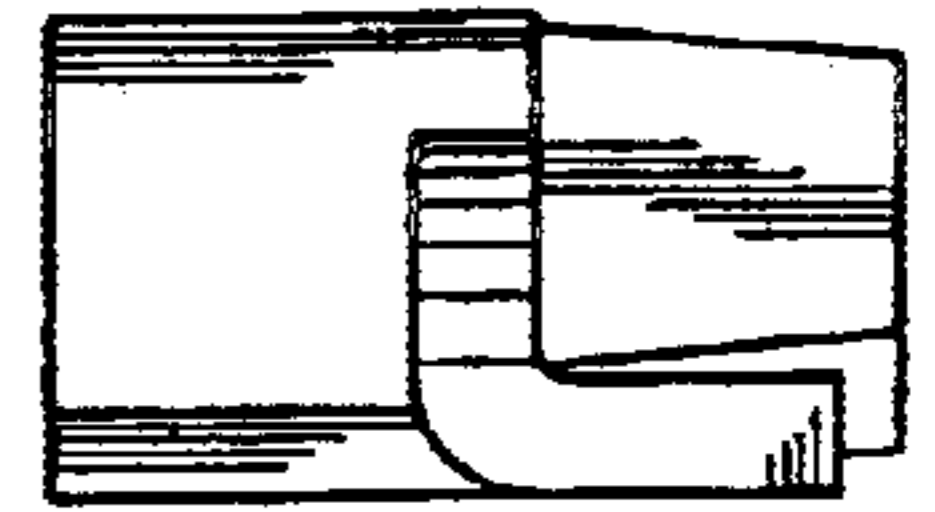

FIG. 5

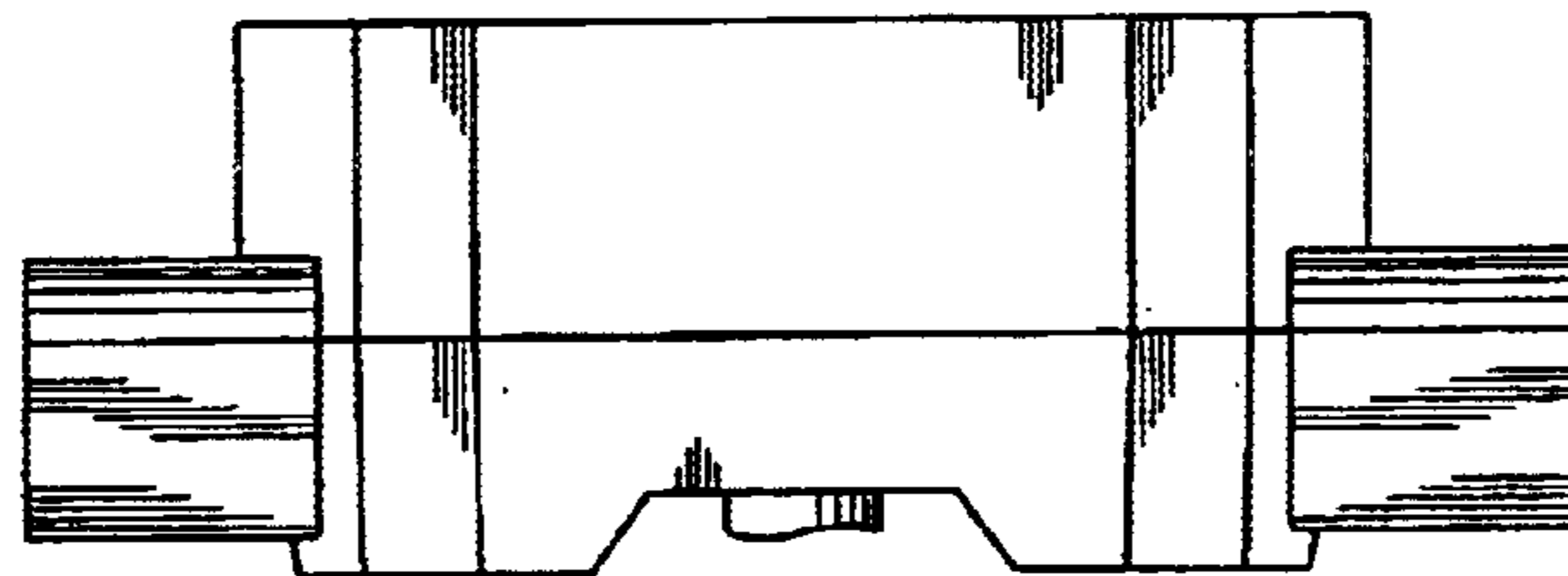

FIG. 6

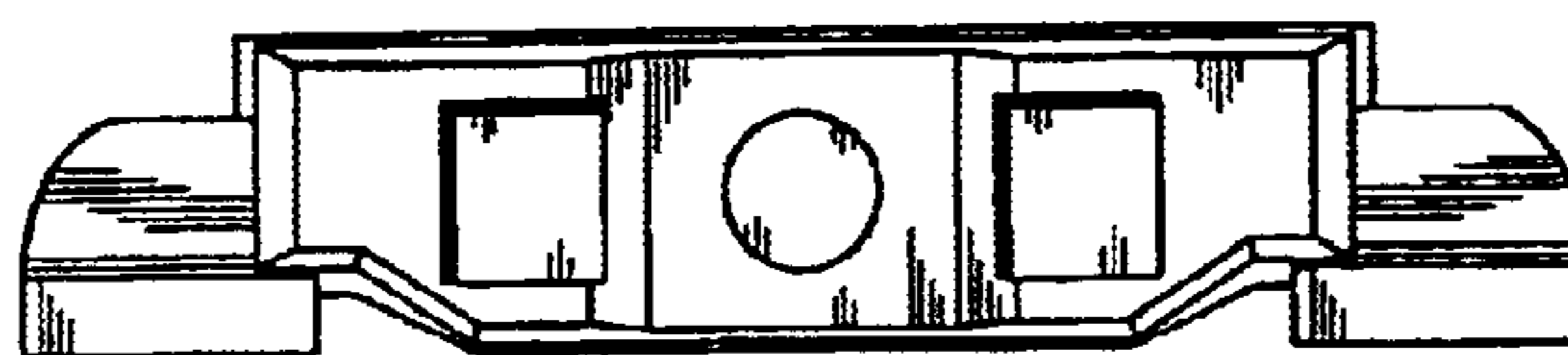

FIG. 7

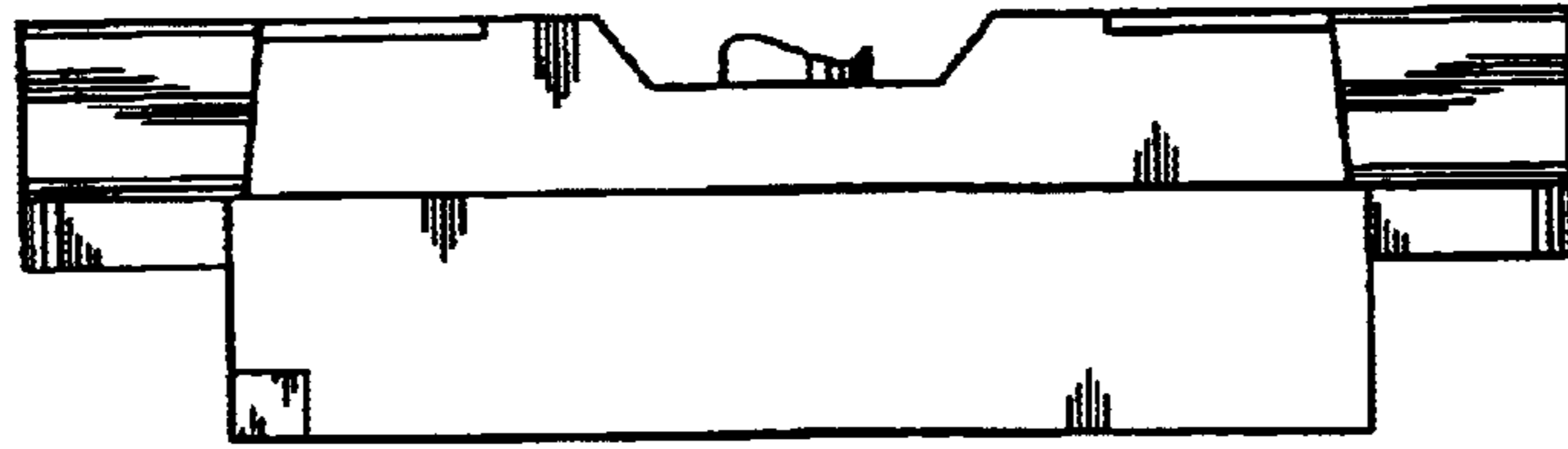

FIG. 8

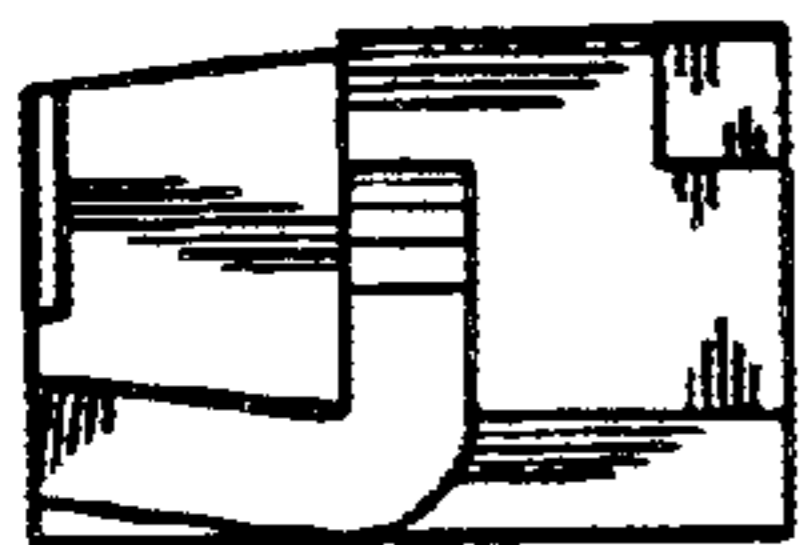

FIG. 9

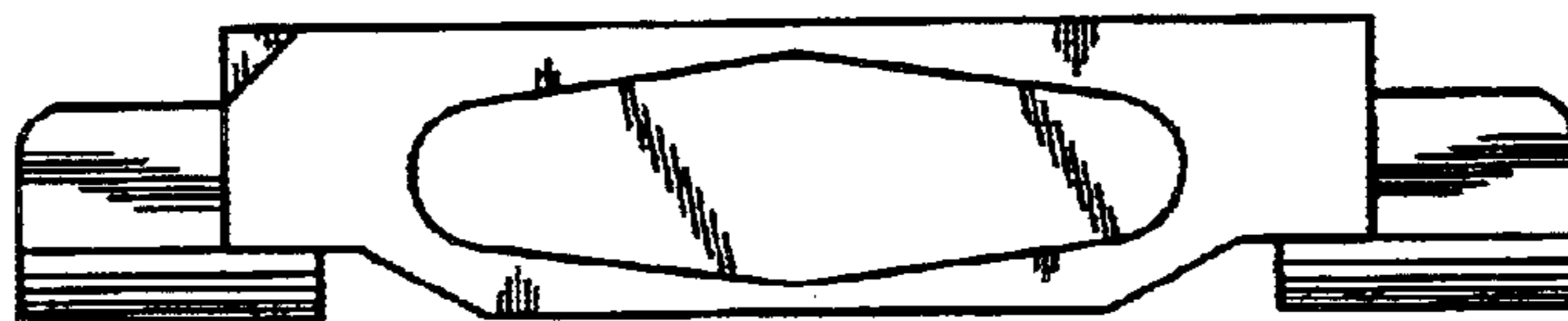

FIG. 10

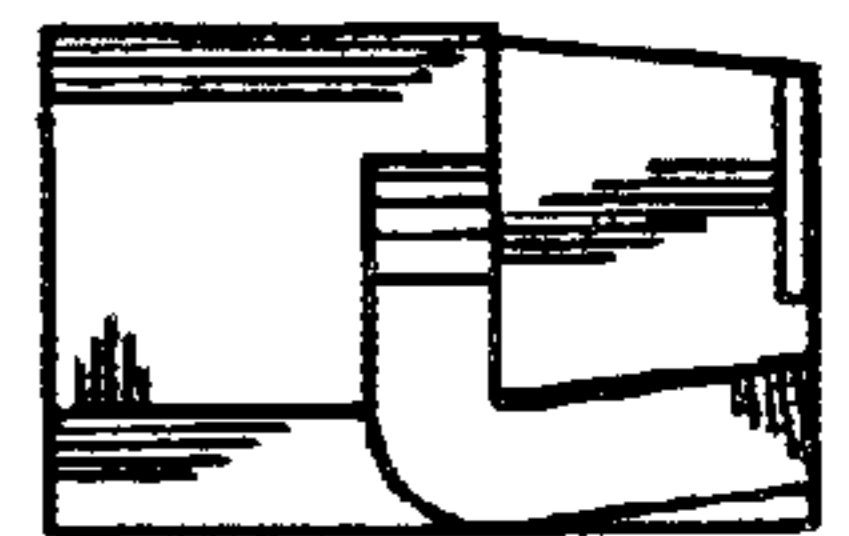

FIG. 11

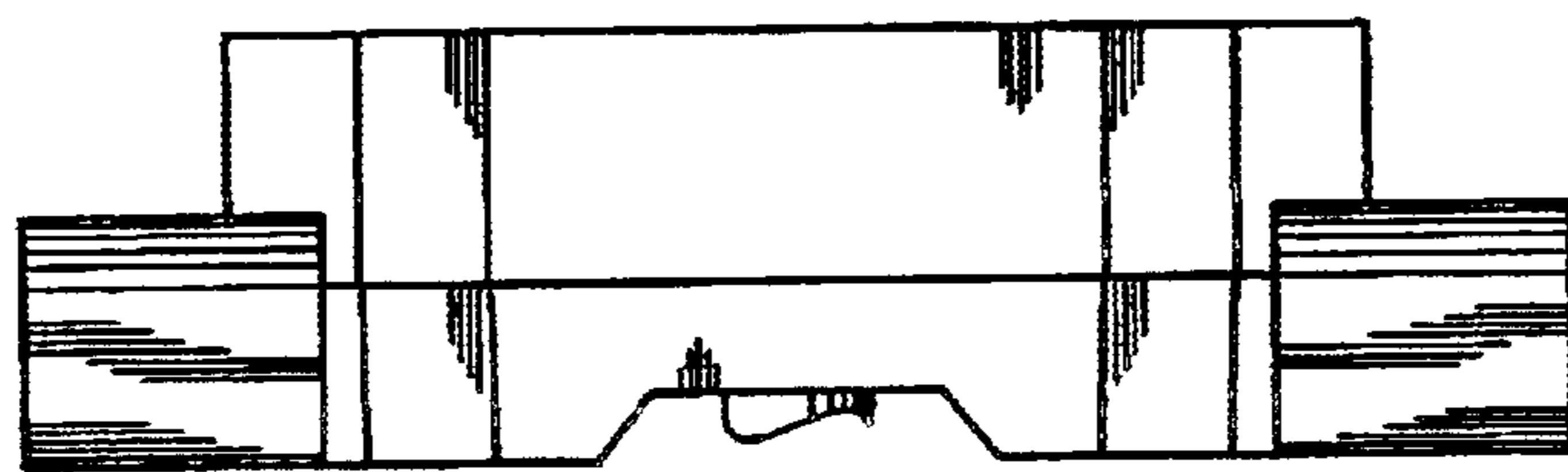

FIG. 12

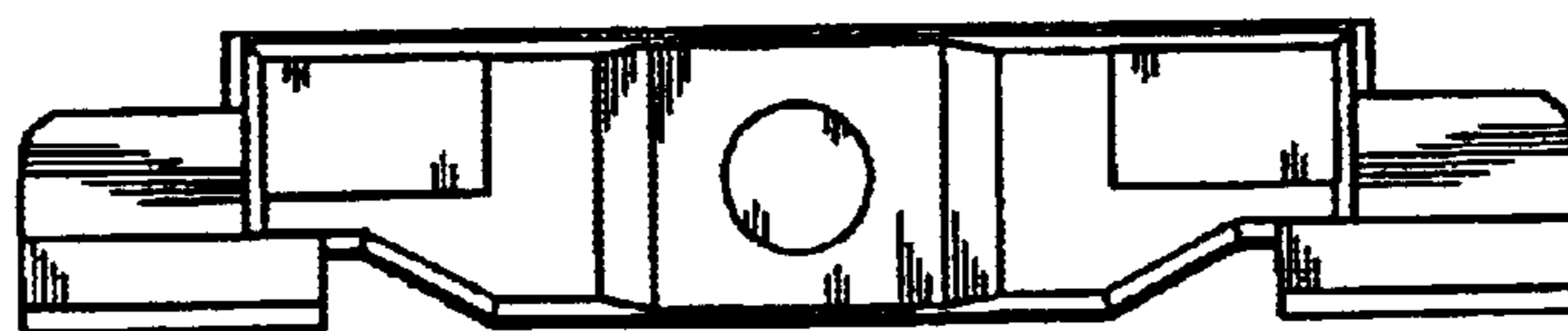

FIG. 13