



US00D491519S

(12) **United States Design Patent**  
**Thieme**

(10) **Patent No.:** **US D491,519 S**

(45) **Date of Patent:** **\*\* Jun. 15, 2004**

(54) **TIRE AIR VALVE MINI HELMET COVER**

D400,422 S 11/1998 Dennison et al.  
D416,799 S 11/1999 Adams  
D425,459 S 5/2000 Sousa

(76) Inventor: **Travis L. Thieme**, 4910 Copper Canyon Blvd., Valrico, FL (US) 33594

\* cited by examiner

(\*\*) Term: **14 Years**

*Primary Examiner*—Robert M. Spear  
(74) *Attorney, Agent, or Firm*—Larson & Larson, PA; James E. Larson

(21) Appl. No.: **29/188,175**

(22) Filed: **Aug. 13, 2003**

(57) **CLAIM**

(51) **LOC (7) Cl.** ..... **12-15**

The ornamental design for a tire air valve mini helmet cover, as shown and described therein.

(52) **U.S. Cl.** ..... **D12/607**

(58) **Field of Search** ..... D9/441, 451; D12/606, D12/607; 137/223, 224, 232, 234.5; 152/427, 429, DIG. 13

**DESCRIPTION**

(56) **References Cited**

**U.S. PATENT DOCUMENTS**

958,867 A	5/1910	Foss	
1,262,743 A	4/1918	Bronson	
D211,031 S	* 5/1968	Eddy	D11/136
3,822,494 A	* 7/1974	Zivica	40/800
D234,433 S	* 3/1975	Zivica	D14/189
D248,651 S	* 7/1978	Zivica	D14/189
D260,468 S	* 9/1981	Huebner	D6/597
D284,563 S	* 7/1986	Merino	D9/451
D378,736 S	* 4/1997	McPhilliamy et al.	D9/447
D391,852 S	3/1998	Tucker	

FIG. 1 is a front elevational view of a tire air valve mini helmet cover showing my novel design; FIG. 2 is a rear elevational view thereof; FIG. 3 is a left side view thereof; FIG. 4 is a right side view thereof; FIG. 5 is a top plan view thereof; FIG. 6 is a bottom plan view thereof; FIG. 7 is a top perspective view of a tire air valve mini helmet cover of the present invention; and, FIG. 8 is a bottom perspective view of a tire air valve helmet cover of the present invention.

**1 Claim, 4 Drawing Sheets**

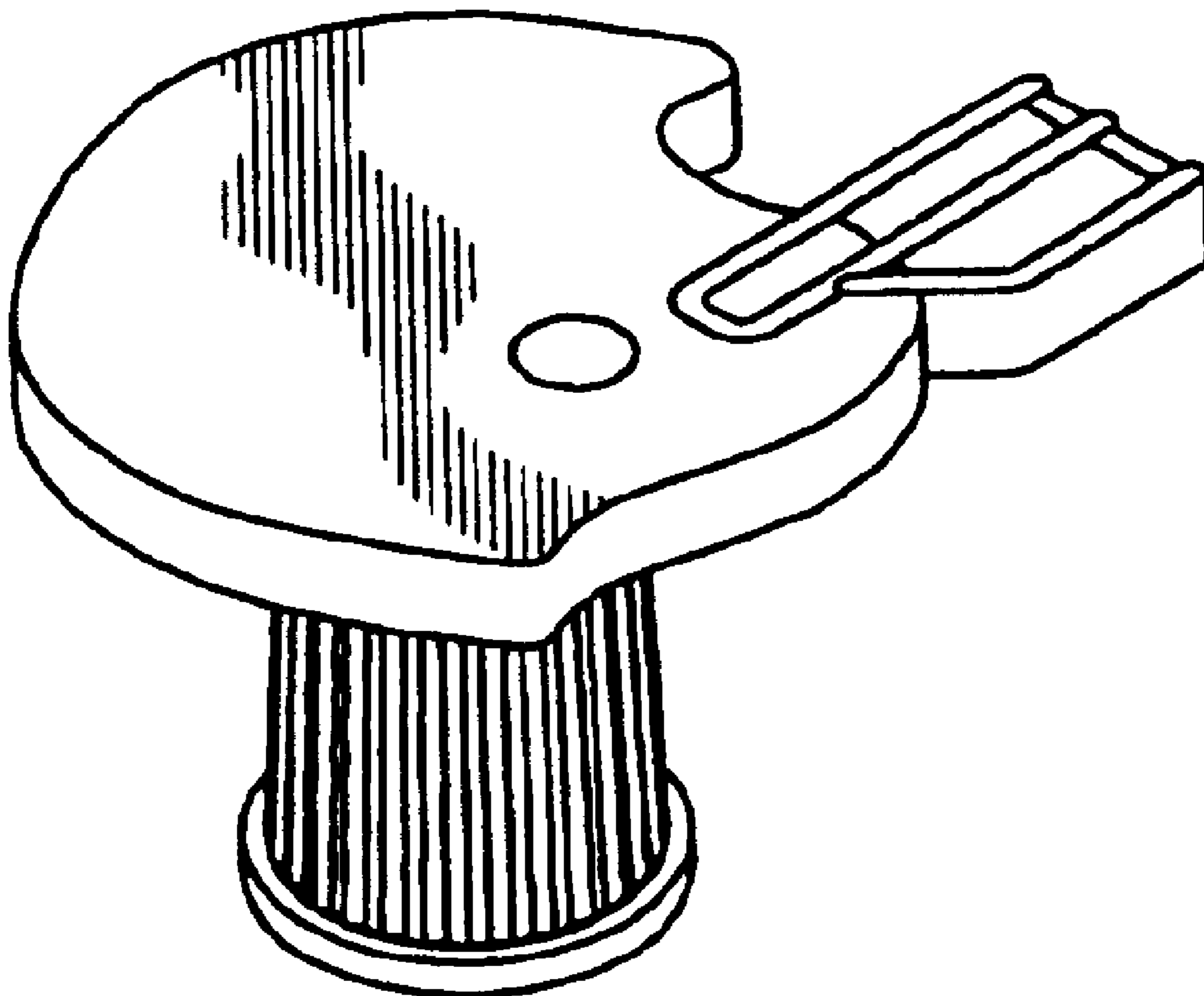

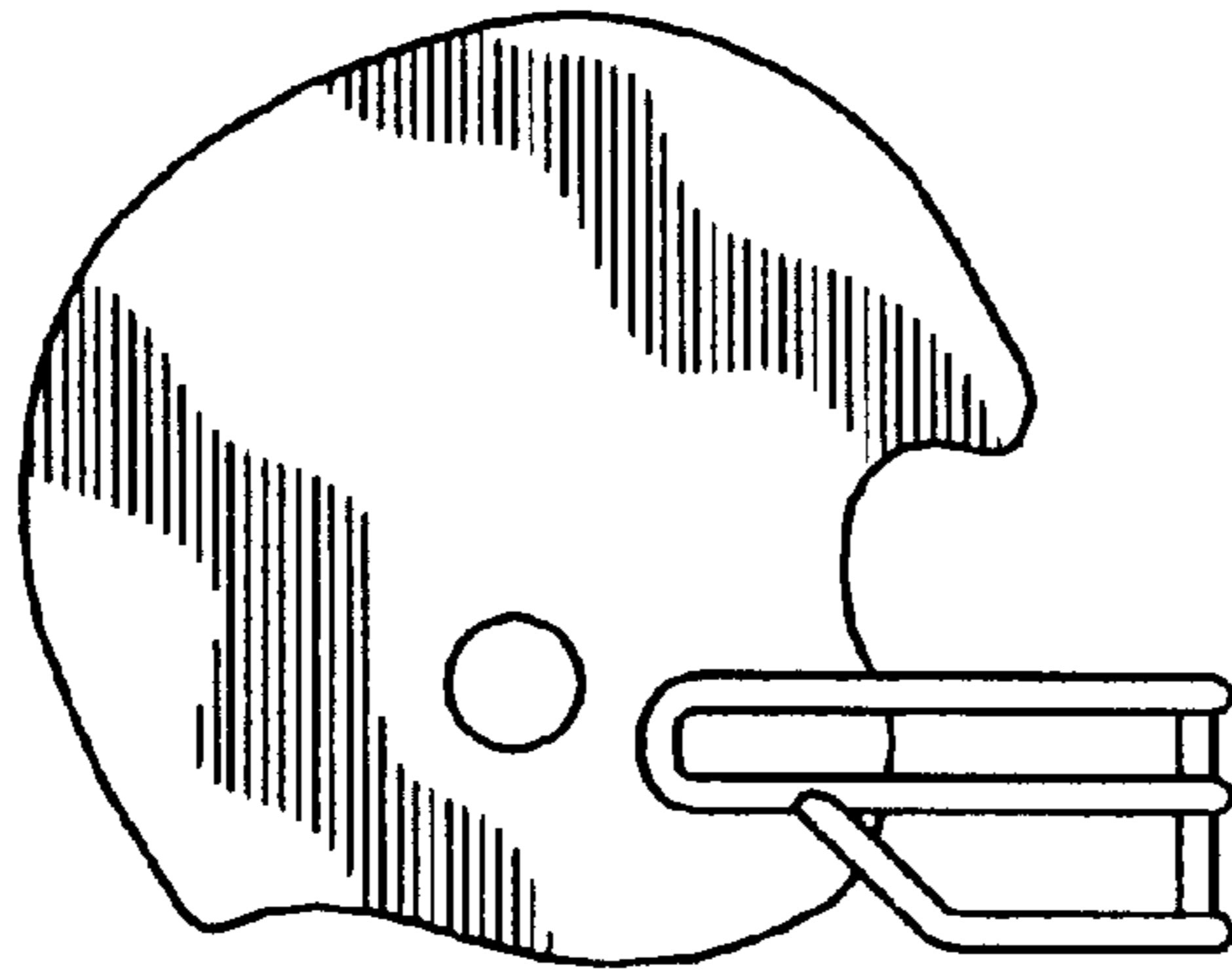

**FIG. 1**

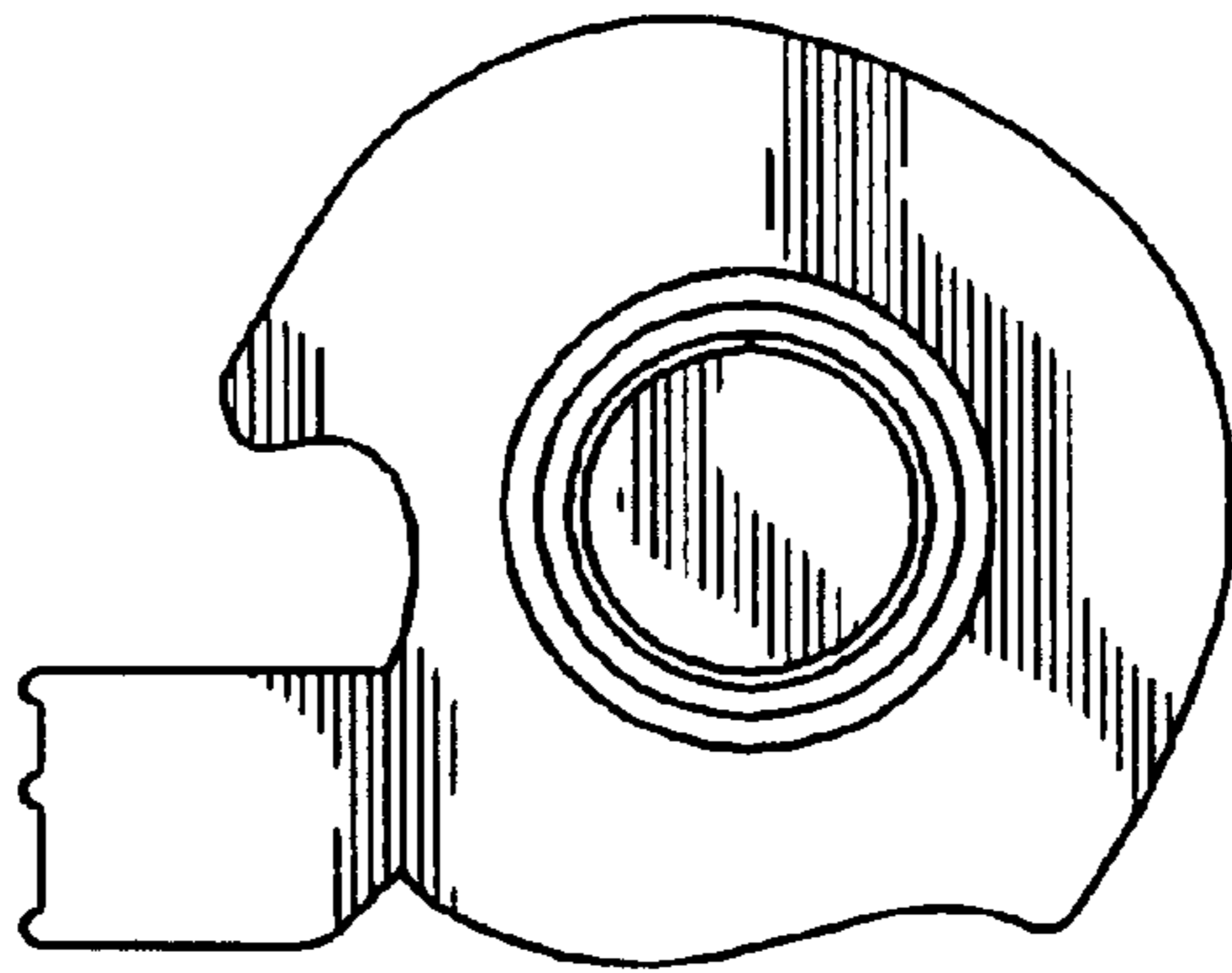

**FIG. 2**

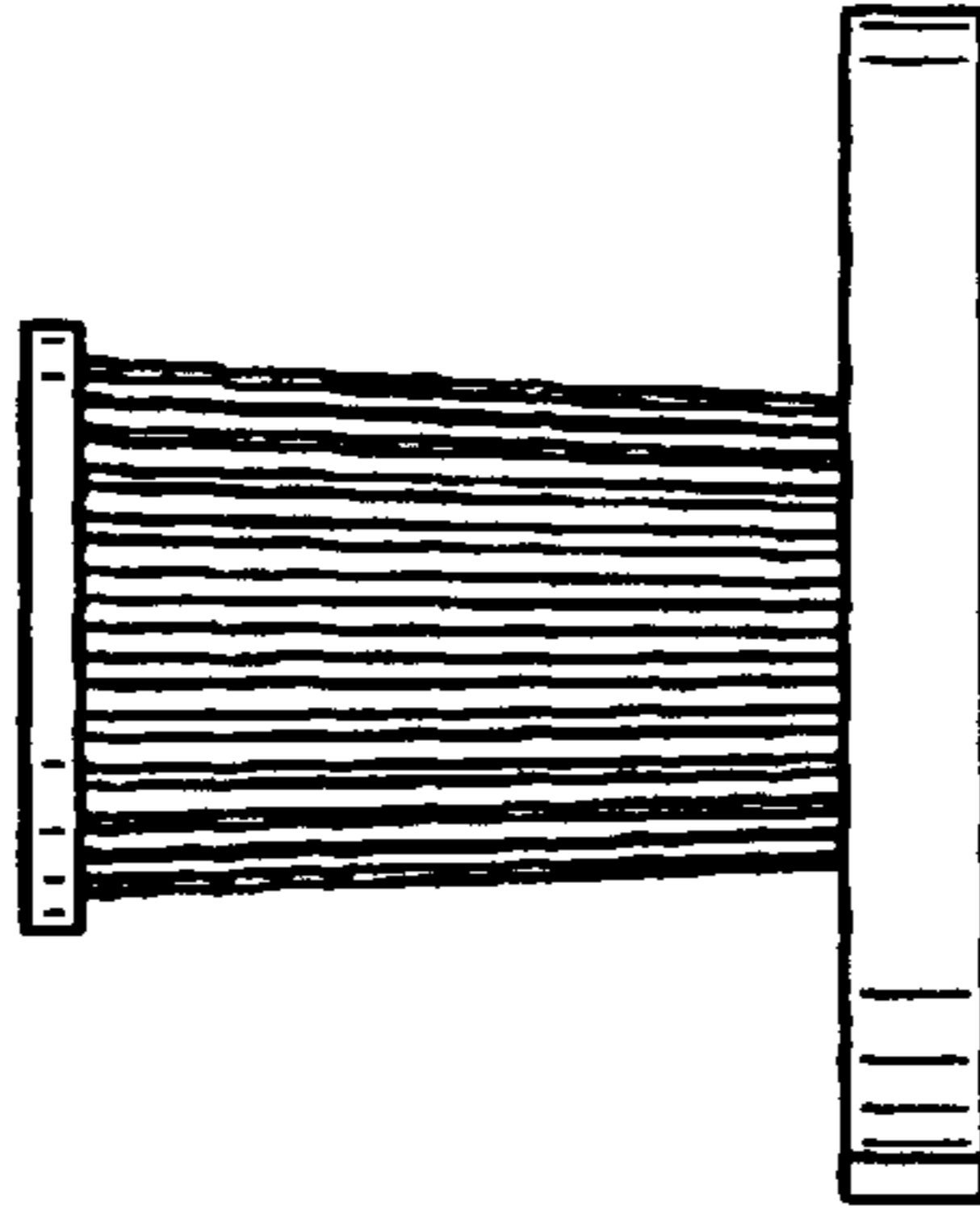

FIG. 3

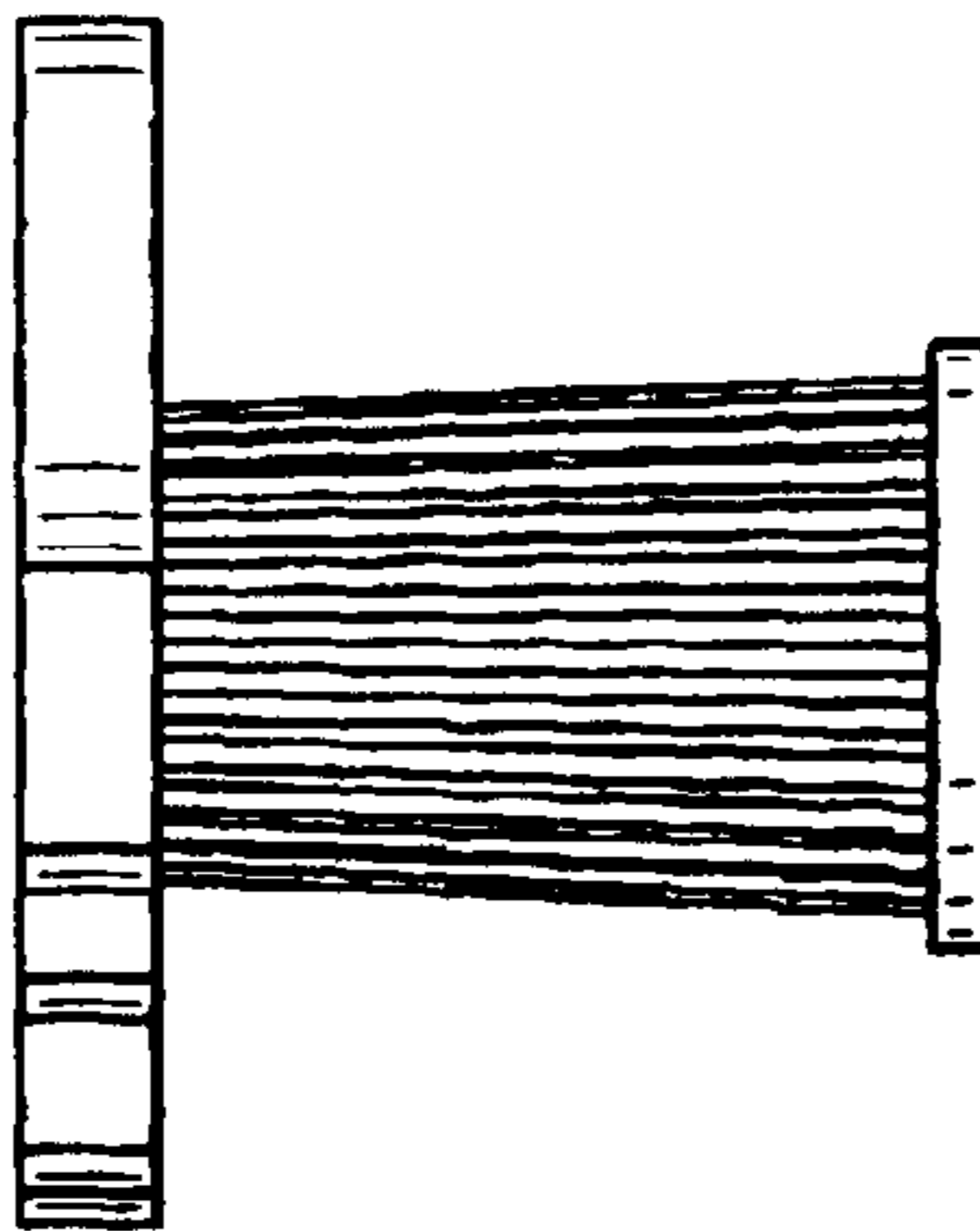

FIG. 4

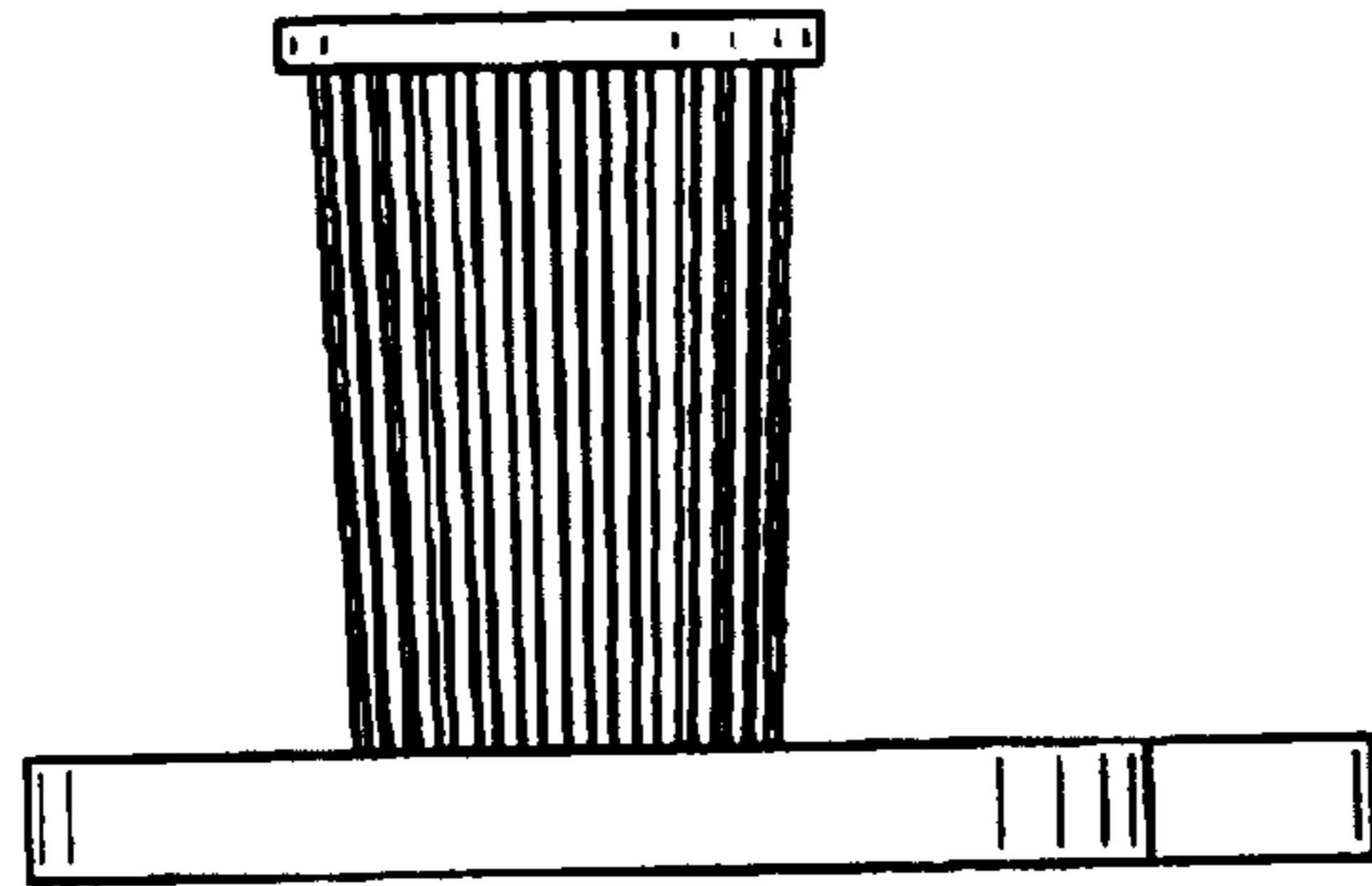

FIG. 5

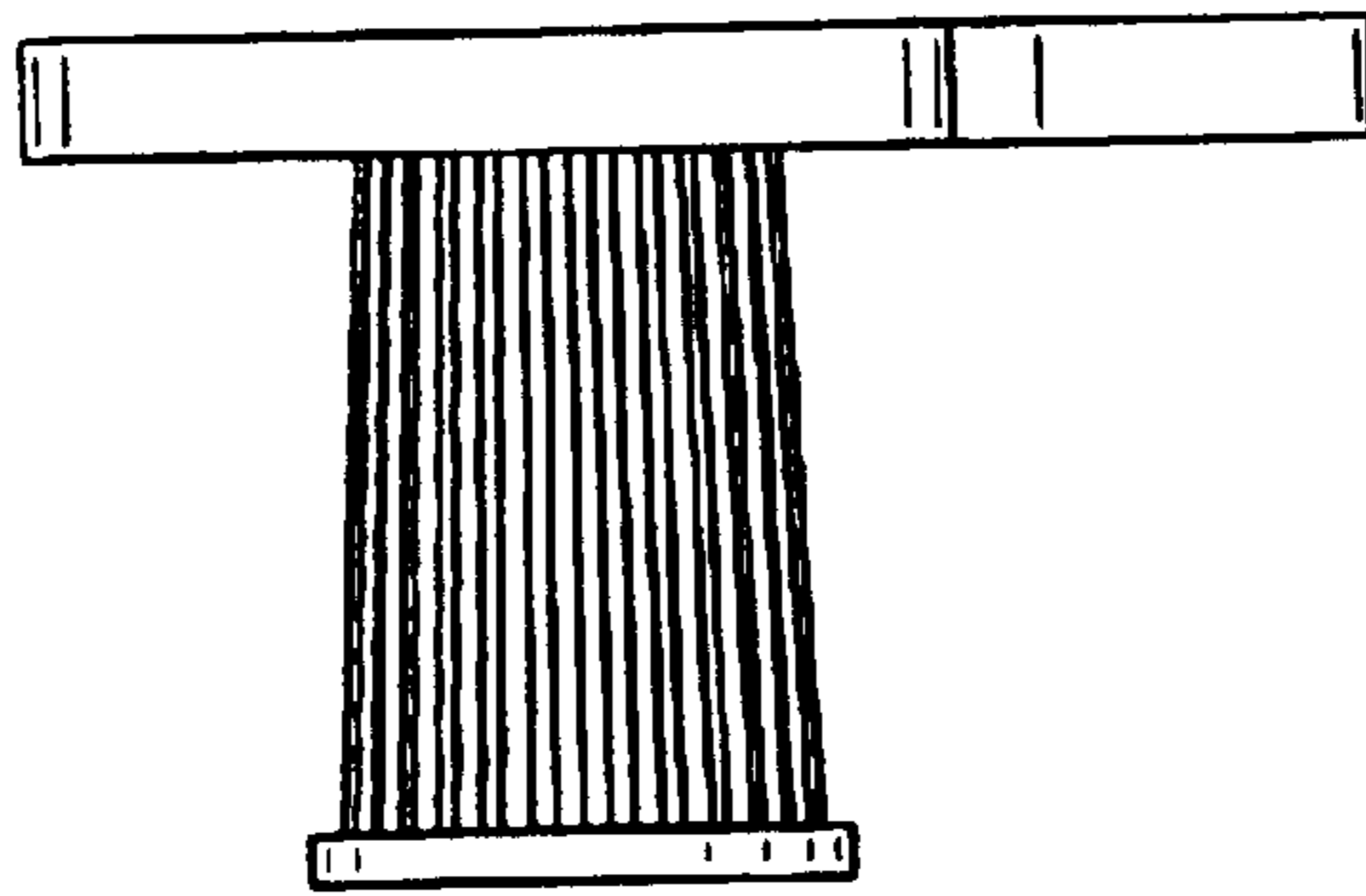
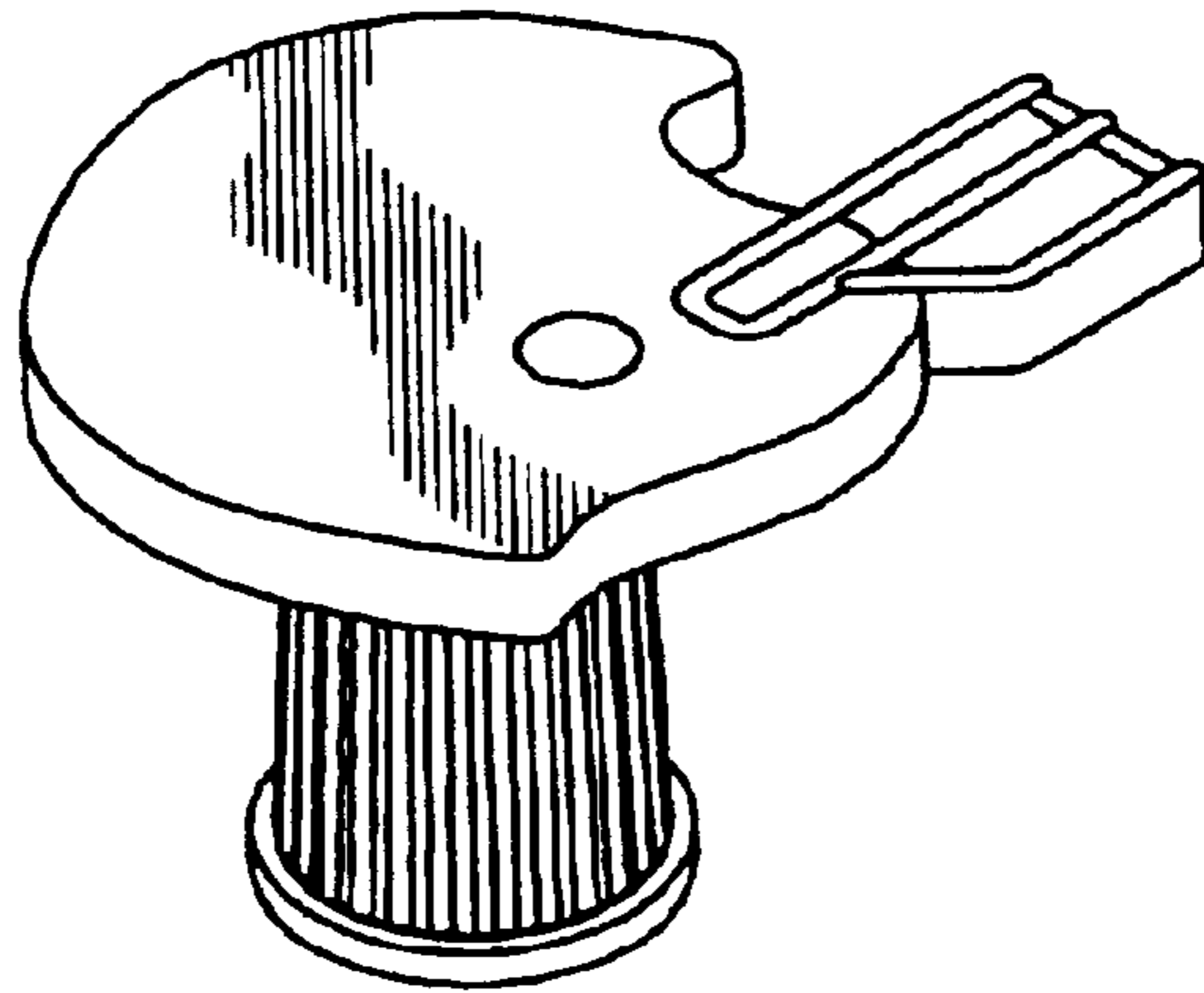
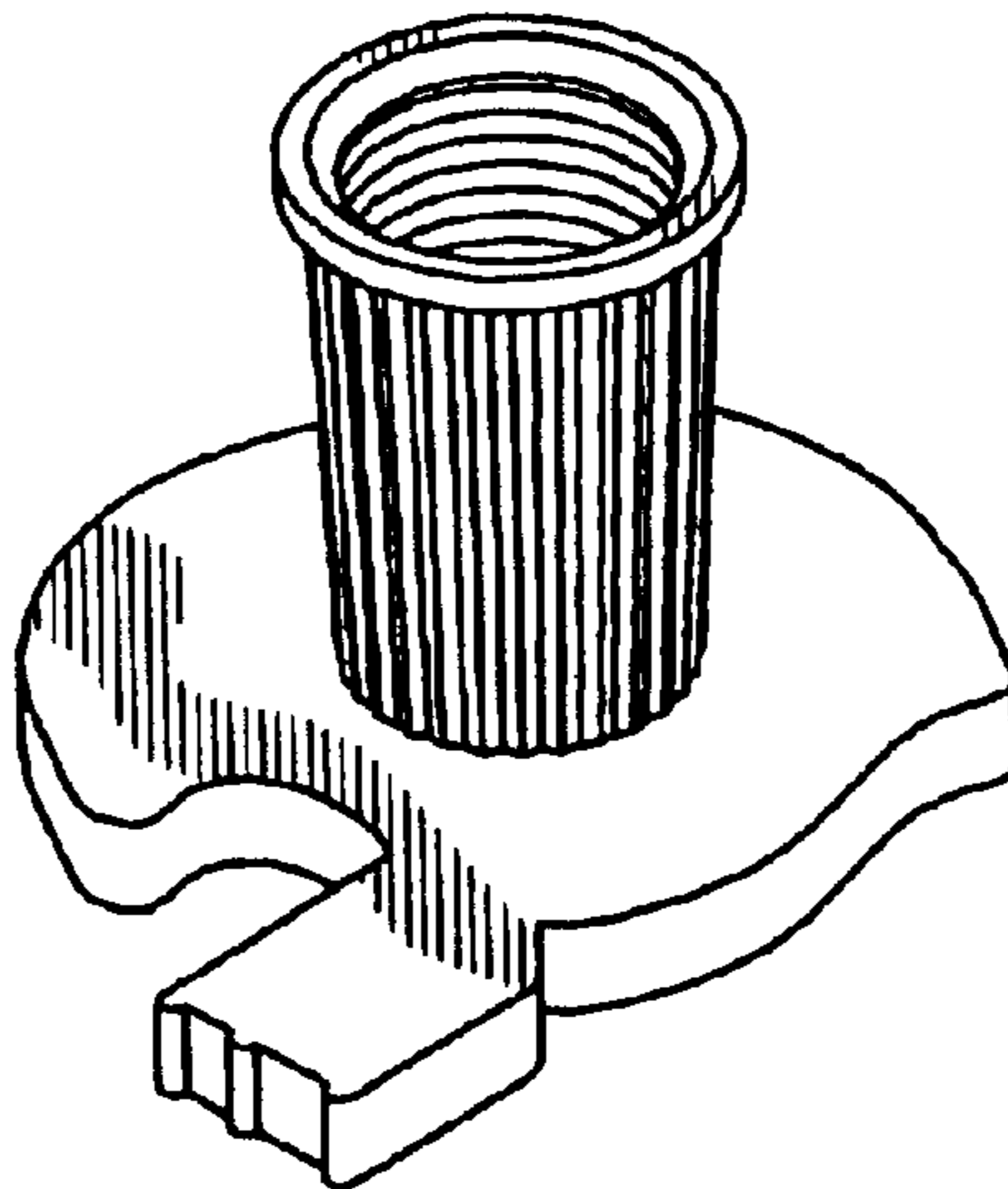

FIG. 6



**FIG. 7**



**FIG. 8**