



US00D491423S

(12) **United States Design Patent**  
**Stamper, III et al.**

(10) **Patent No.:** **US D491,423 S**  
(45) **Date of Patent:** **\*\* Jun. 15, 2004**

(54) **JUICER**

(75) Inventors: **George William Stamper, III**, Quinton,  
VA (US); **Jeffrey Thomas Mauch**,  
Mechanicsville, VA (US)

(73) Assignee: **Hamilton Beach/Proctor-Silex, Inc.**,  
Glen Allen, VA (US)

(\*\*) Term: **14 Years**

(21) Appl. No.: **29/185,176**

(22) Filed: **Jun. 24, 2003**

(51) **LOC (7) Cl.** ..... **07-04**

(52) **U.S. Cl.** ..... **D7/665**

(58) **Field of Search** ..... D7/665, 666, 678;  
241/100; 99/501-508, 348, 357, 492, 499

(56) **References Cited**

**U.S. PATENT DOCUMENTS**

D69,603 S	3/1926	Loomis	
1,674,475 A	6/1928	Loomis	
1,933,738 A	11/1933	Kazoian	
D251,405 S	3/1979	Ackeret	
4,378,730 A	4/1983	Coggiola	
D283,002 S	3/1986	Daenen	
5,088,392 A *	2/1992	Ancona et al.	99/499
5,193,447 A	3/1993	Lucas et al.	
5,445,069 A	8/1995	Lucas et al.	

D379,744 S	6/1997	Thackray
D395,803 S	7/1998	Lallemand
6,070,519 A	6/2000	Sham et al.
6,135,018 A	10/2000	Yu et al.
6,138,556 A	10/2000	Yu et al.
D436,503 S	1/2001	Choi
D437,188 S	2/2001	Thackray
6,363,837 B1	4/2002	Sham et al.

\* cited by examiner

*Primary Examiner*—Terry A. Wallace

(74) *Attorney, Agent, or Firm*—Akin Gump Strauss Hauer & Feld, LLP

(57) **CLAIM**

The ornamental design for a juicer, as shown and described.

**DESCRIPTION**

FIG. 1 is a front perspective view of the juicer in accordance with our new design;

FIG. 2 is a top plan view thereof;

FIG. 3 is a front elevational view thereof;

FIG. 4 is a right-side elevational view thereof;

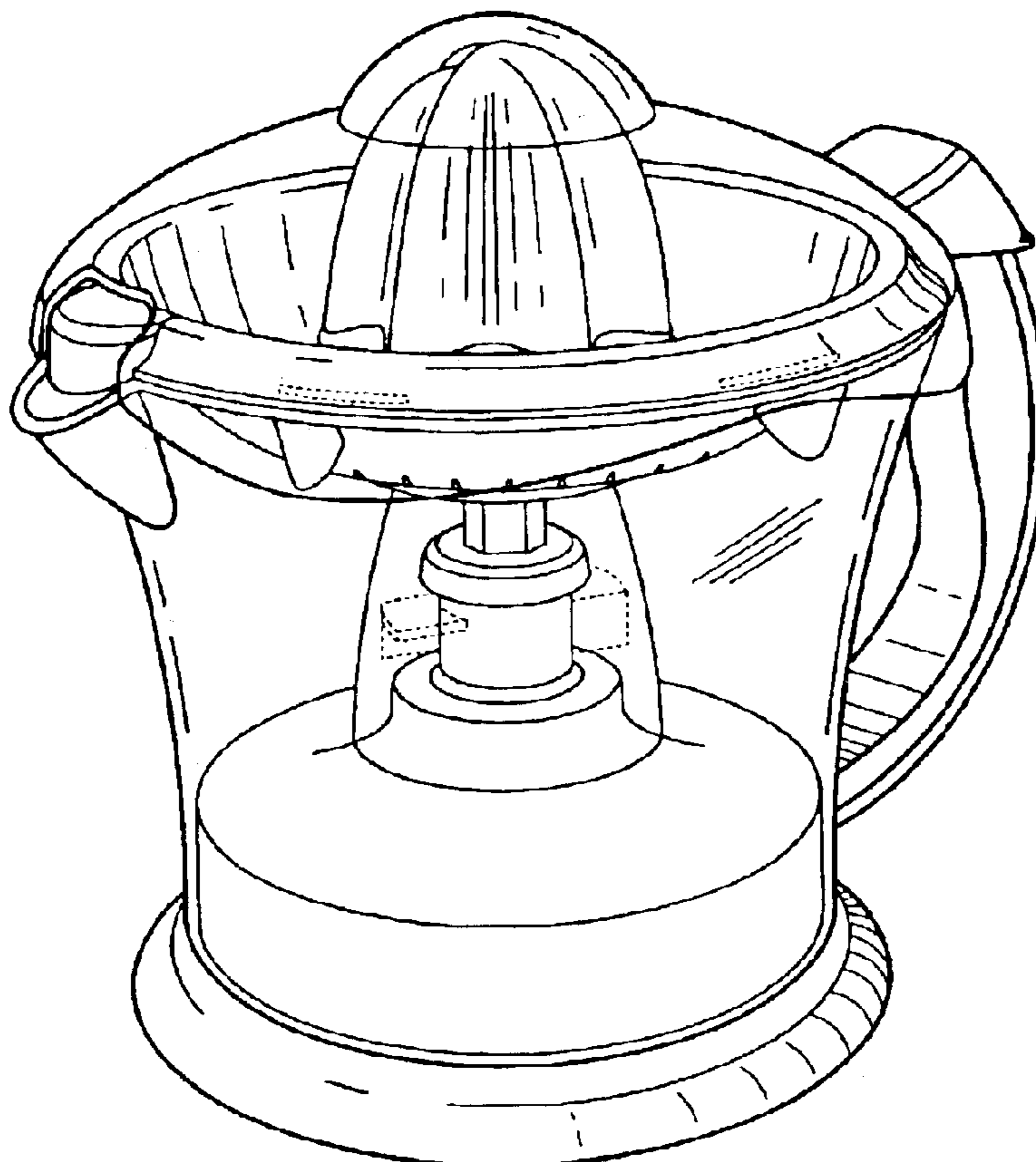
FIG. 5 is a left-side elevational view thereof;

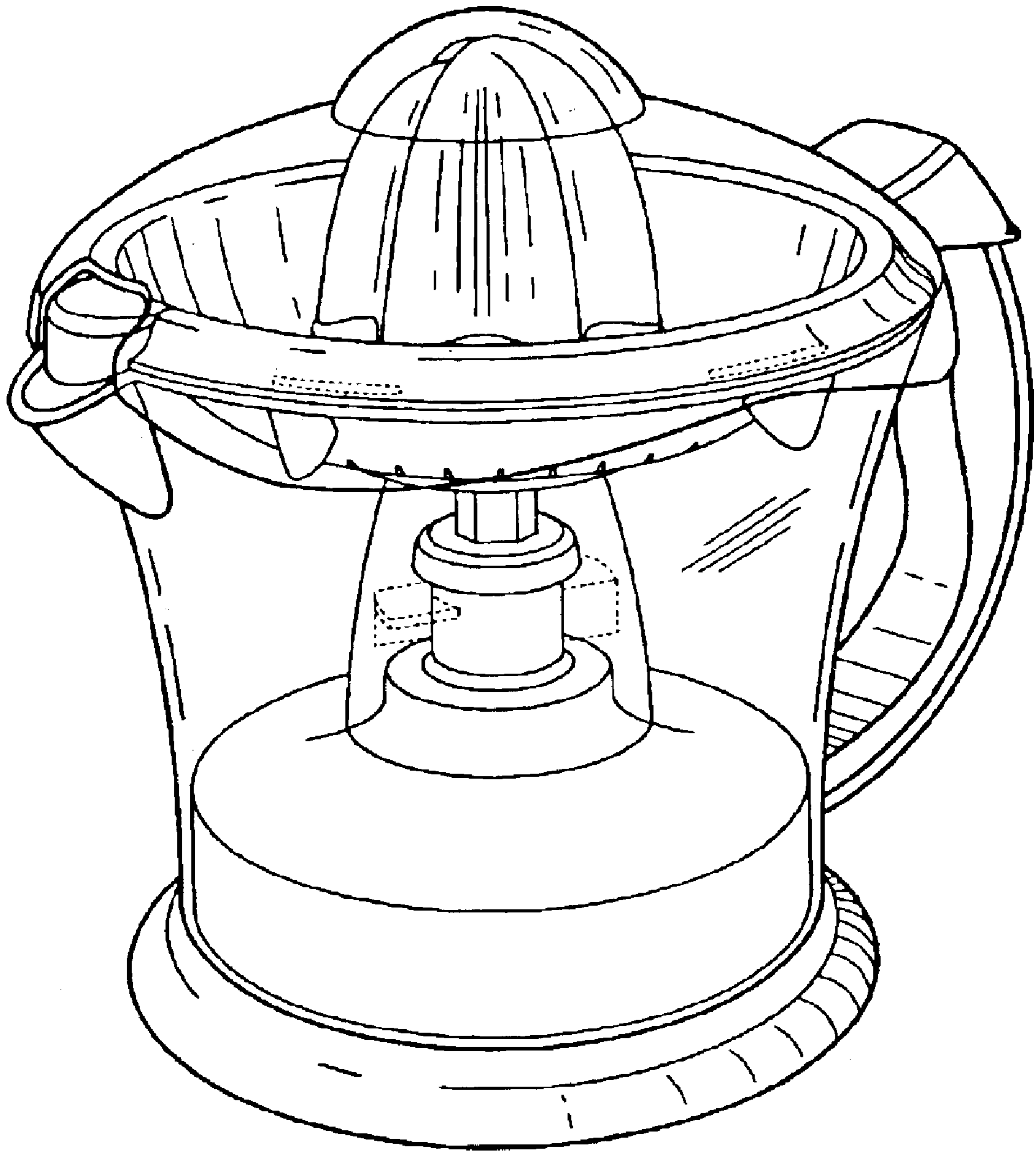
FIG. 6 is a rear elevational view thereof; and,

FIG. 7 is a bottom plan view thereof.

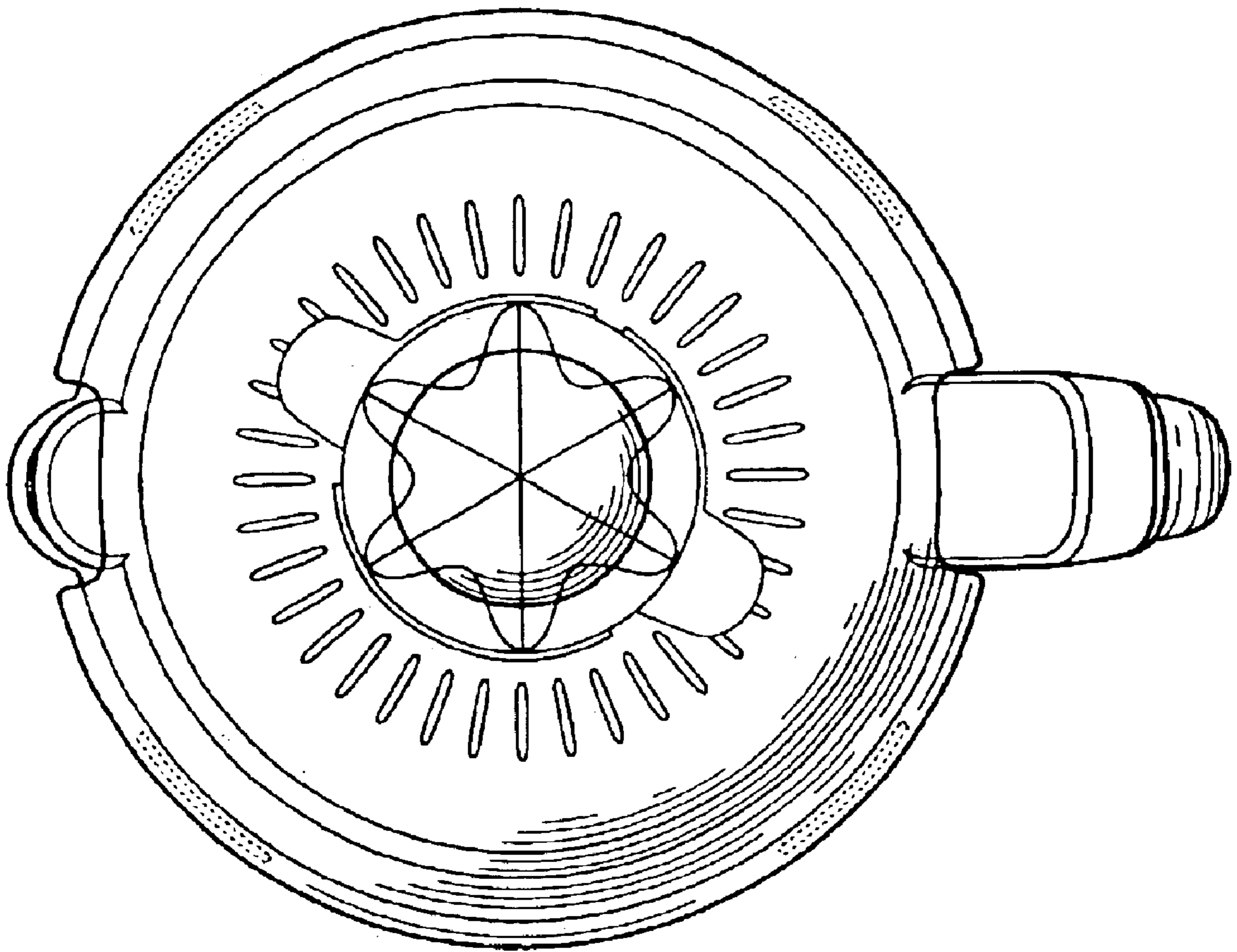
The broken lines in the figures are for illustrative purposes only and form no part of the claimed design.

**1 Claim, 7 Drawing Sheets**

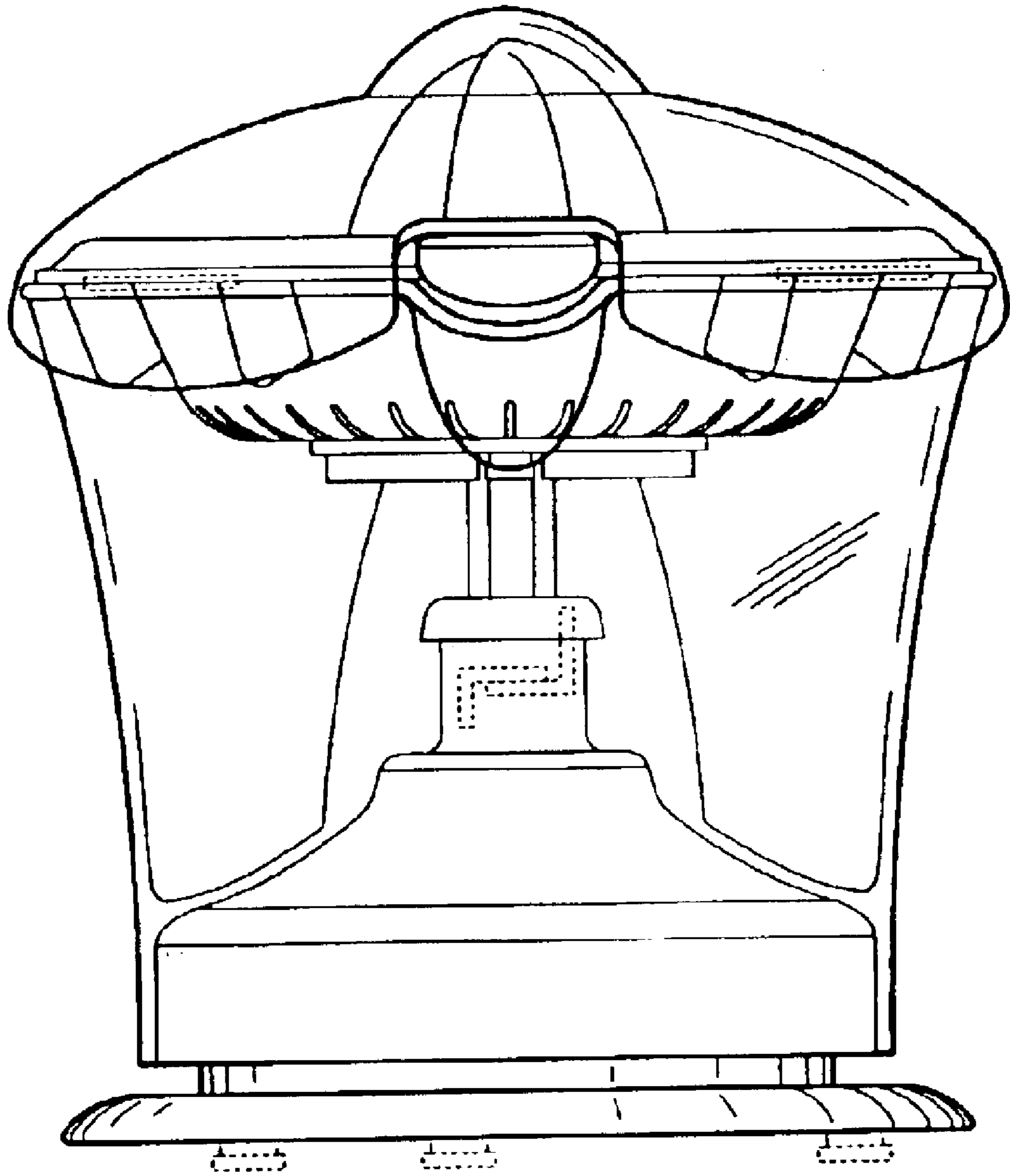




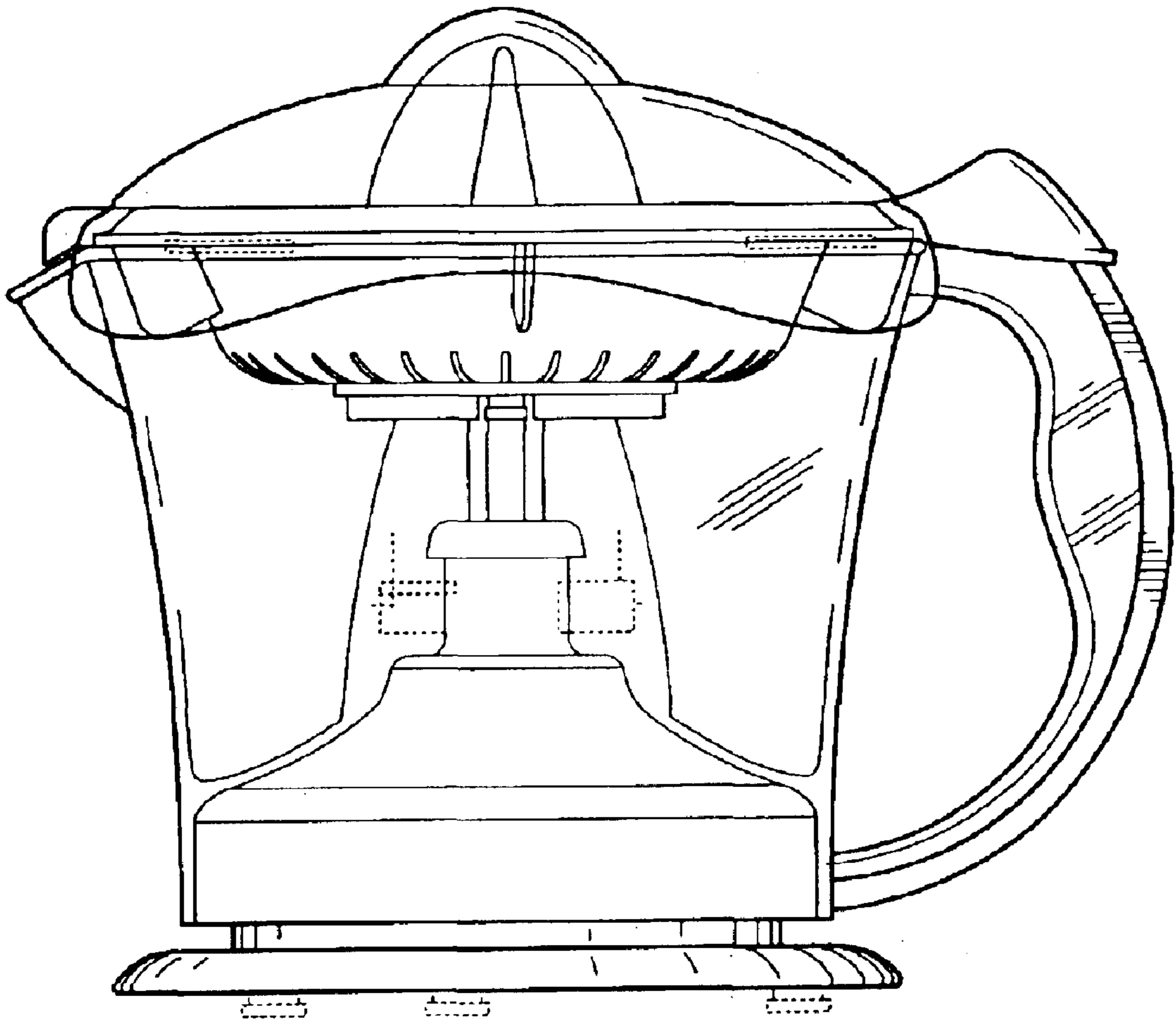
**FIG. 1**



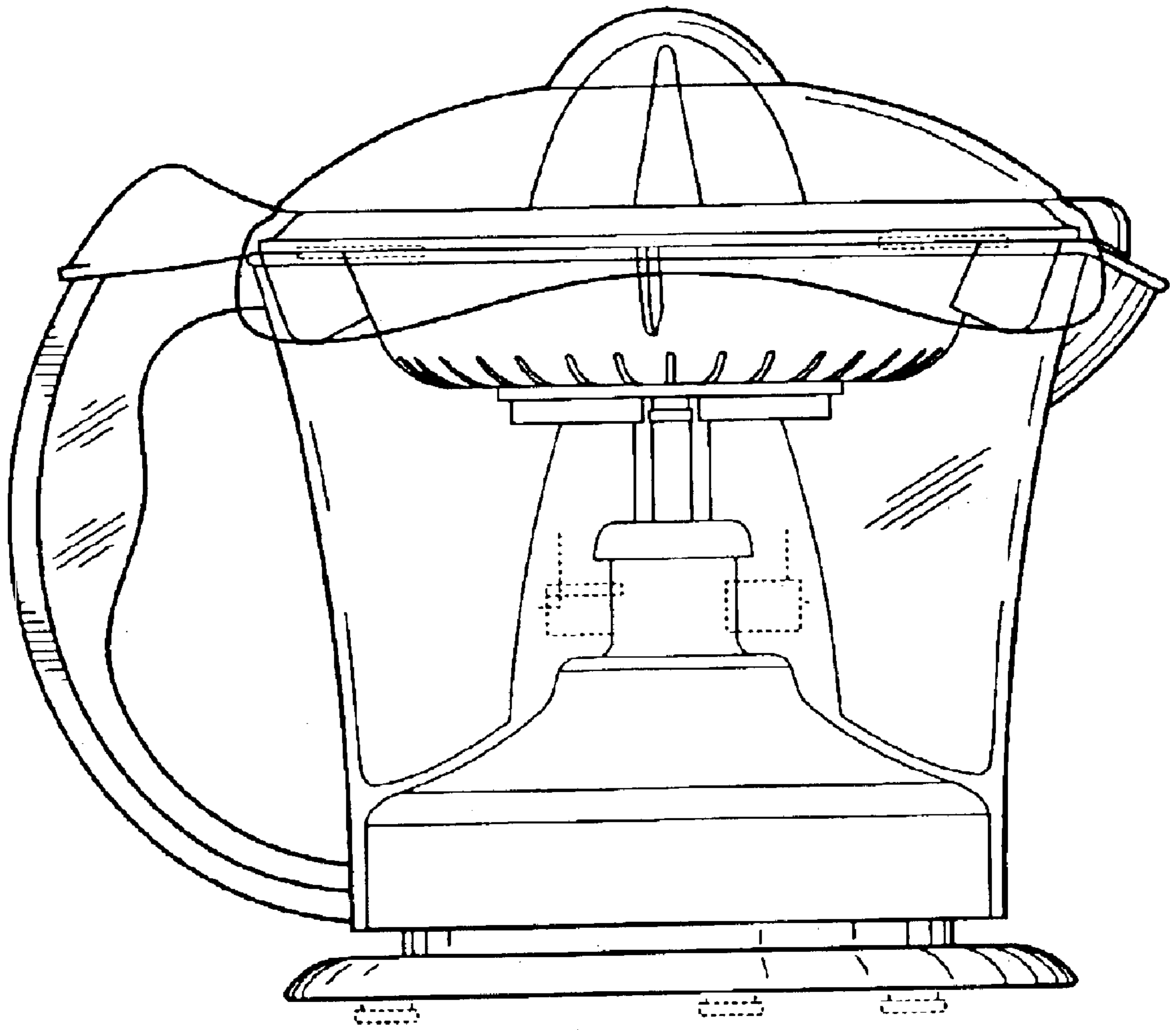
**FIG. 2**



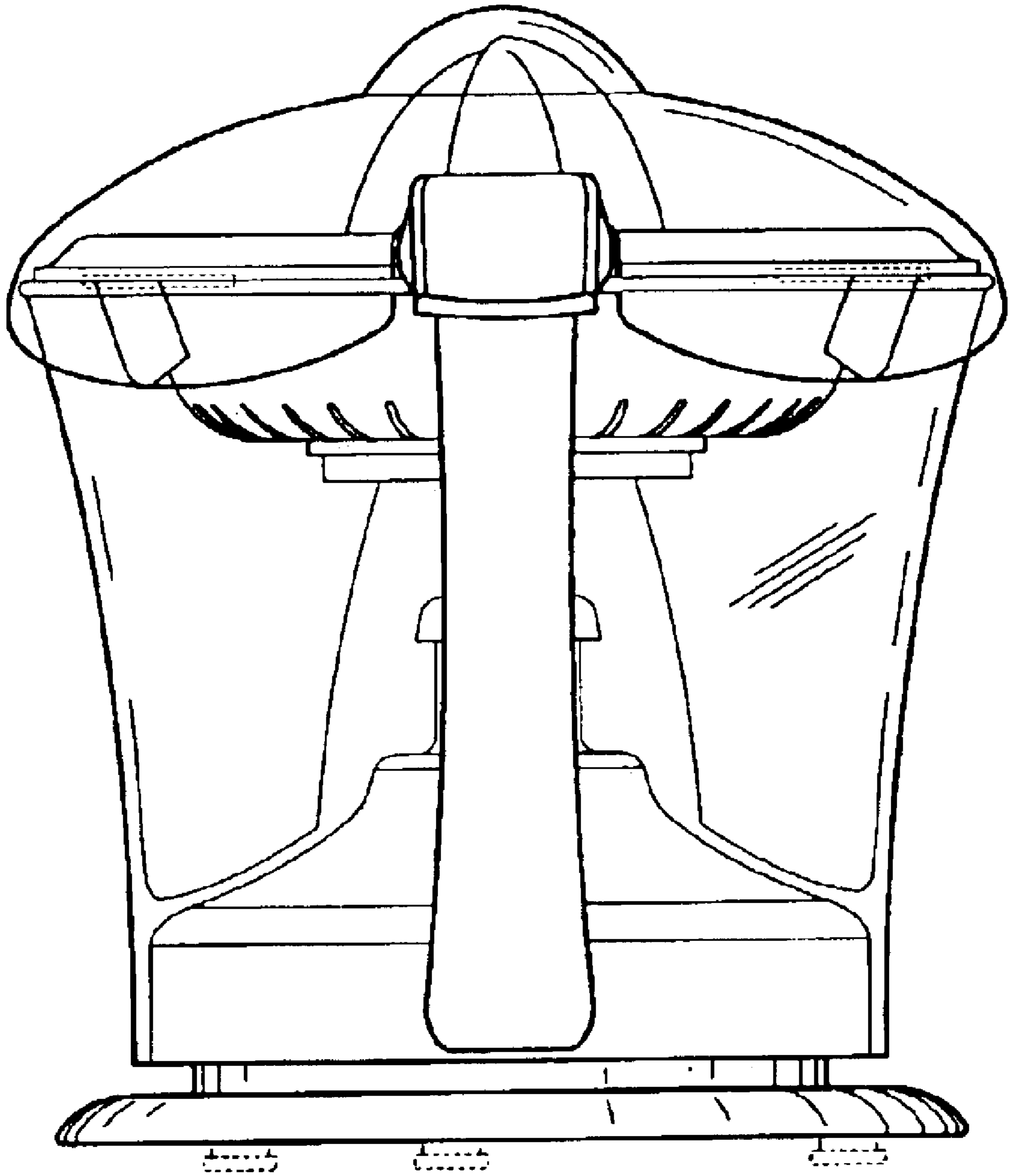
**FIG. 3**



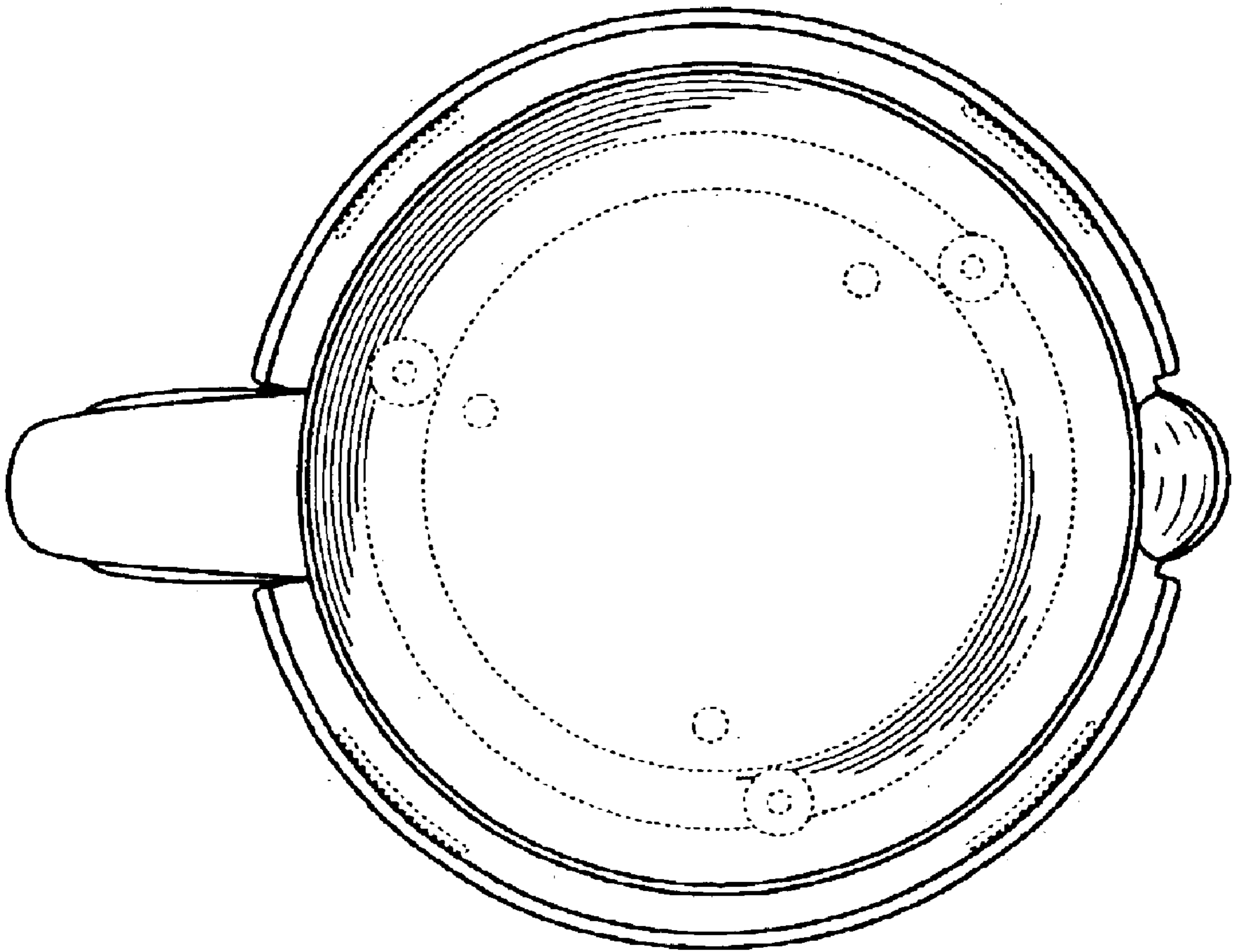
**FIG. 4**



**FIG. 5**



**FIG. 6**



**FIG. 7**