



US00D491326S

(12) **United States Design Patent**
Schröter

(10) **Patent No.:** **US D491,326 S**

(45) **Date of Patent:** **** Jun. 8, 2004**

(54) **VACUUM CLEANER CONNECTOR**

(75) **Inventor:** **Jörg Schröter, Gröbenzell (DE)**

(73) **Assignee:** **Bsh Bosch und Siemens Hausgeraete GmbH, Munich (DE)**

(**) **Term:** **14 Years**

(21) **Appl. No.:** **29/146,647**

(22) **Filed:** **Aug. 13, 2001**

(30) **Foreign Application Priority Data**

Feb. 13, 2001 (WO) DM/055 245

(51) **LOC (7) Cl.** **15-05**

(52) **U.S. Cl.** **D32/31**

(58) **Field of Search** D32/31-33, 22,
D32/25, 34; 15/322, 327.1-327.7, 329,
350, 361-362, 377, 393, 398, 400-401,
411, 415.1-422.1; 285/7, 302, 181

(56) **References Cited**

U.S. PATENT DOCUMENTS

- D212,711 S * 11/1968 McLane D32/34
- D215,490 S * 10/1969 Descarries D32/34
- D237,036 S * 10/1975 Neceda D32/31
- D240,791 S * 8/1976 Bednarski et al. D32/34
- 4,052,767 A * 10/1977 Dutcher 15/377

- 4,165,140 A * 8/1979 Lyman et al. 439/192
- D259,117 S * 5/1981 Ueda D32/31
- 4,611,365 A * 9/1986 Komatsu et al. 15/339
- 4,669,755 A * 6/1987 Harris et al. 285/7
- 4,961,245 A * 10/1990 Barnes, Jr. et al. 15/339
- 5,716,076 A * 2/1998 Tamborini et al. 285/7
- D406,422 S * 3/1999 Burchard et al. D32/34

* cited by examiner

Primary Examiner—Ruth McInroy
(74) *Attorney, Agent, or Firm*—Laurence A. Greenberg;
Werner H. Stemer; Gregory L. Mayback

(57) **CLAIM**

The ornamental design for a vacuum cleaner connector, as shown and described.

DESCRIPTION

FIG. 1 is a top perspective view of a vacuum cleaner connector showing my new design;
FIG. 2 is a bottom perspective view thereof;
FIG. 3 is a left side view thereof;
FIG. 4 is a front view thereof;
FIG. 5 is a right side view thereof;
FIG. 6 is a rear view thereof;
FIG. 7 is a top view thereof; and,
FIG. 8 is a bottom view thereof.

1 Claim, 4 Drawing Sheets

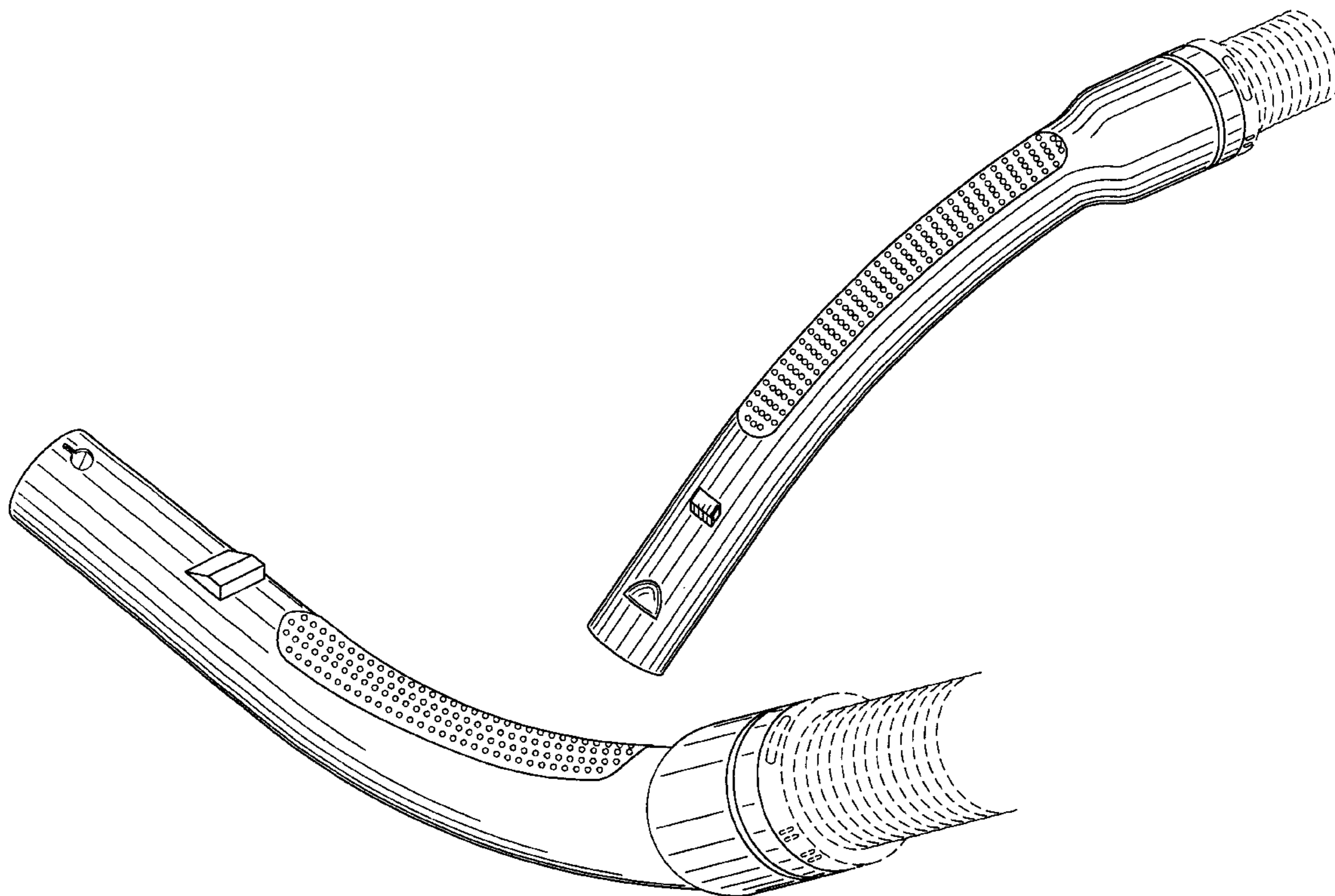

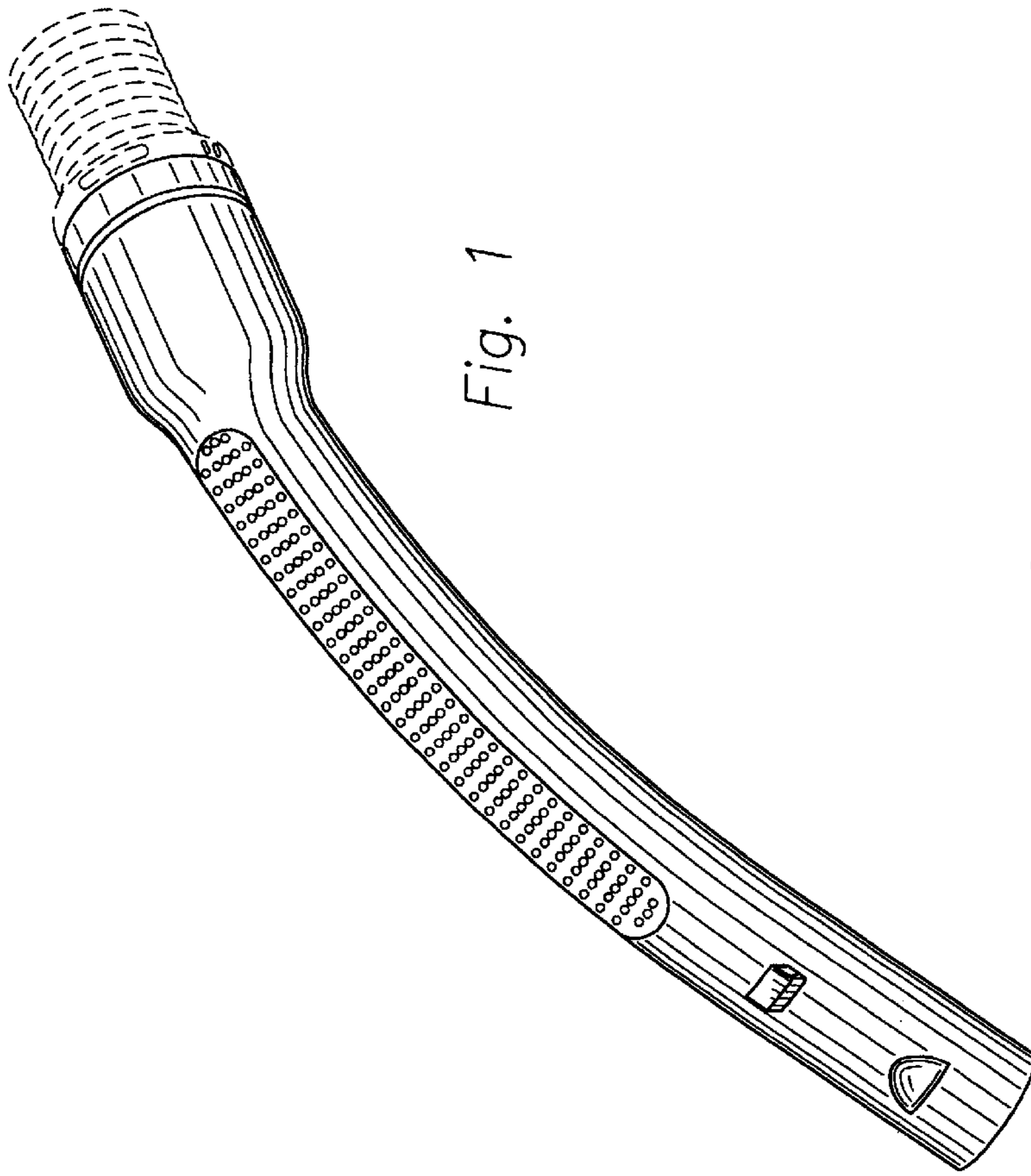

Fig. 1

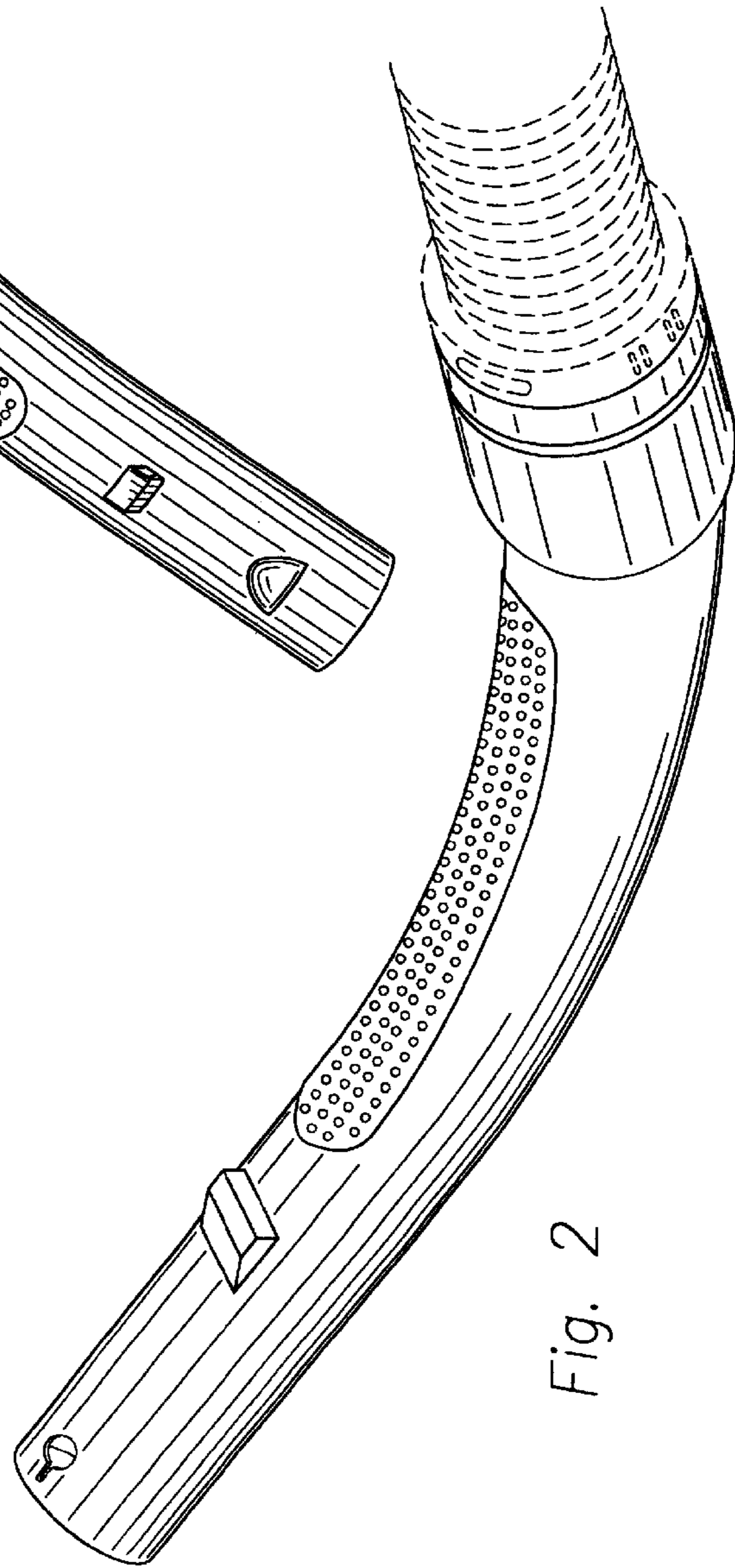

Fig. 2

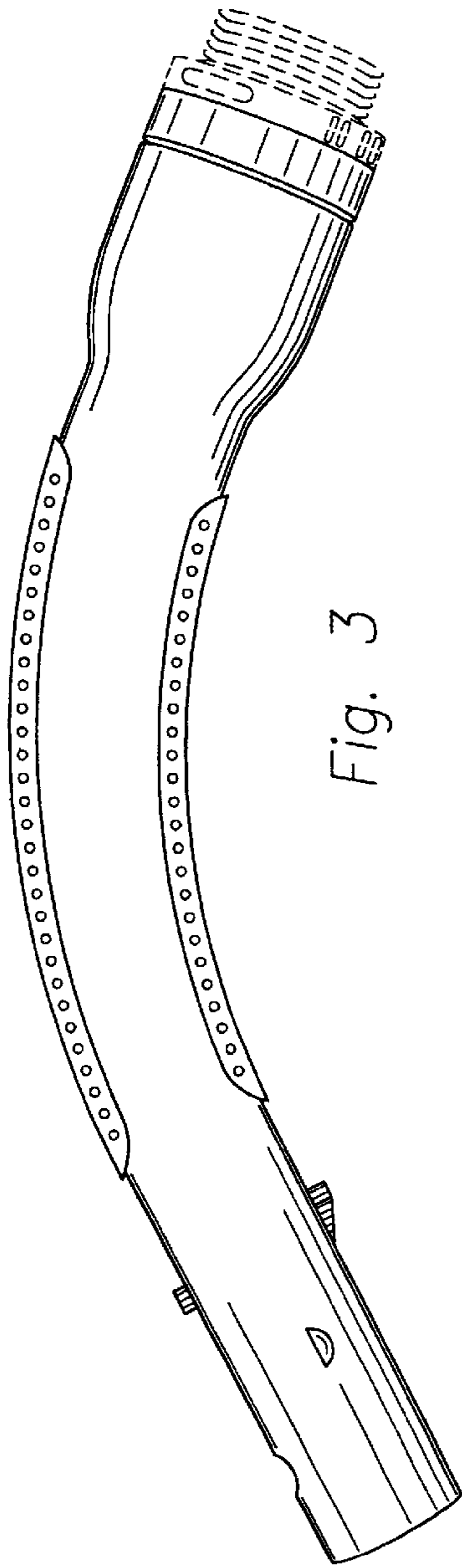

Fig. 3

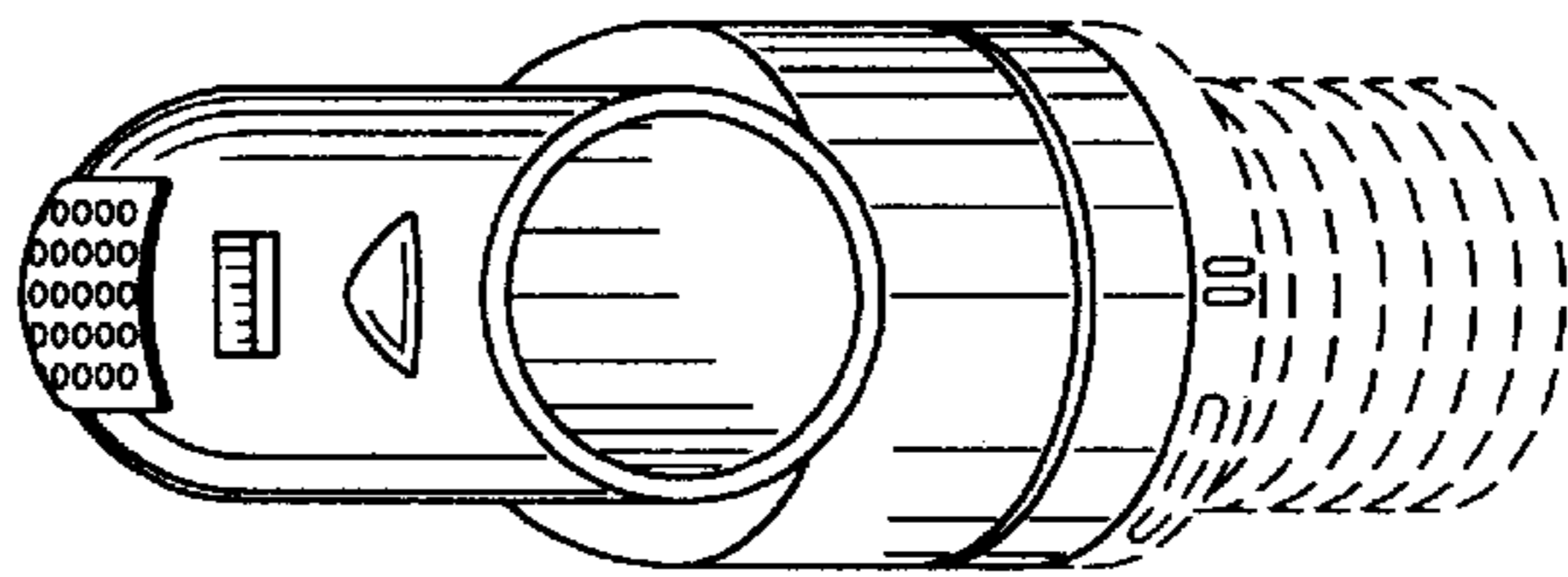

Fig. 4

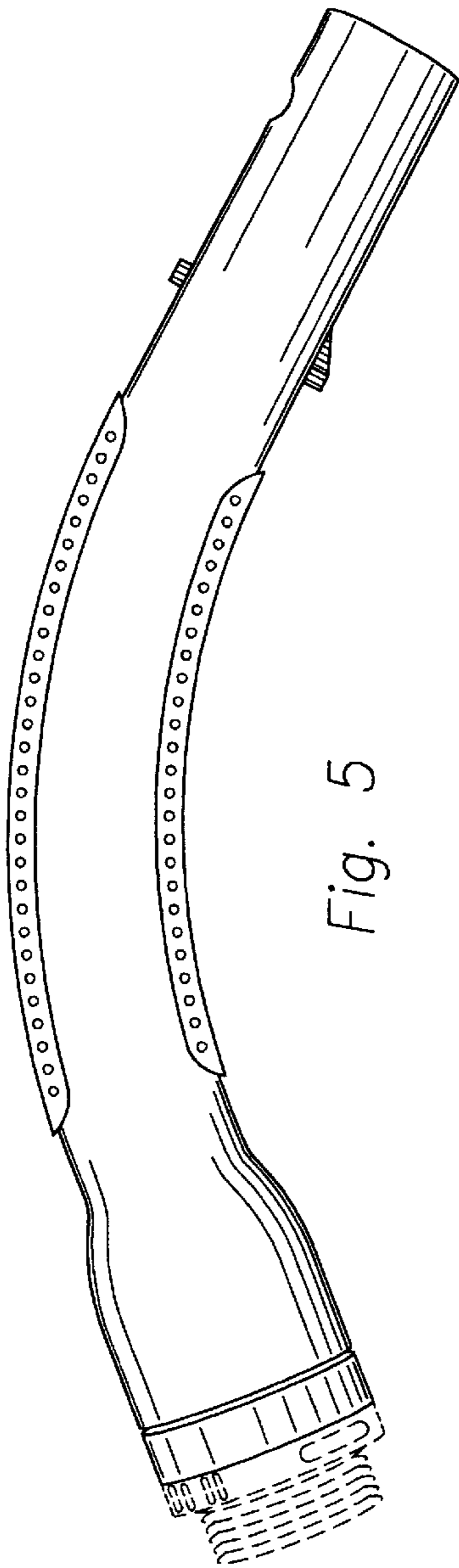

Fig. 5

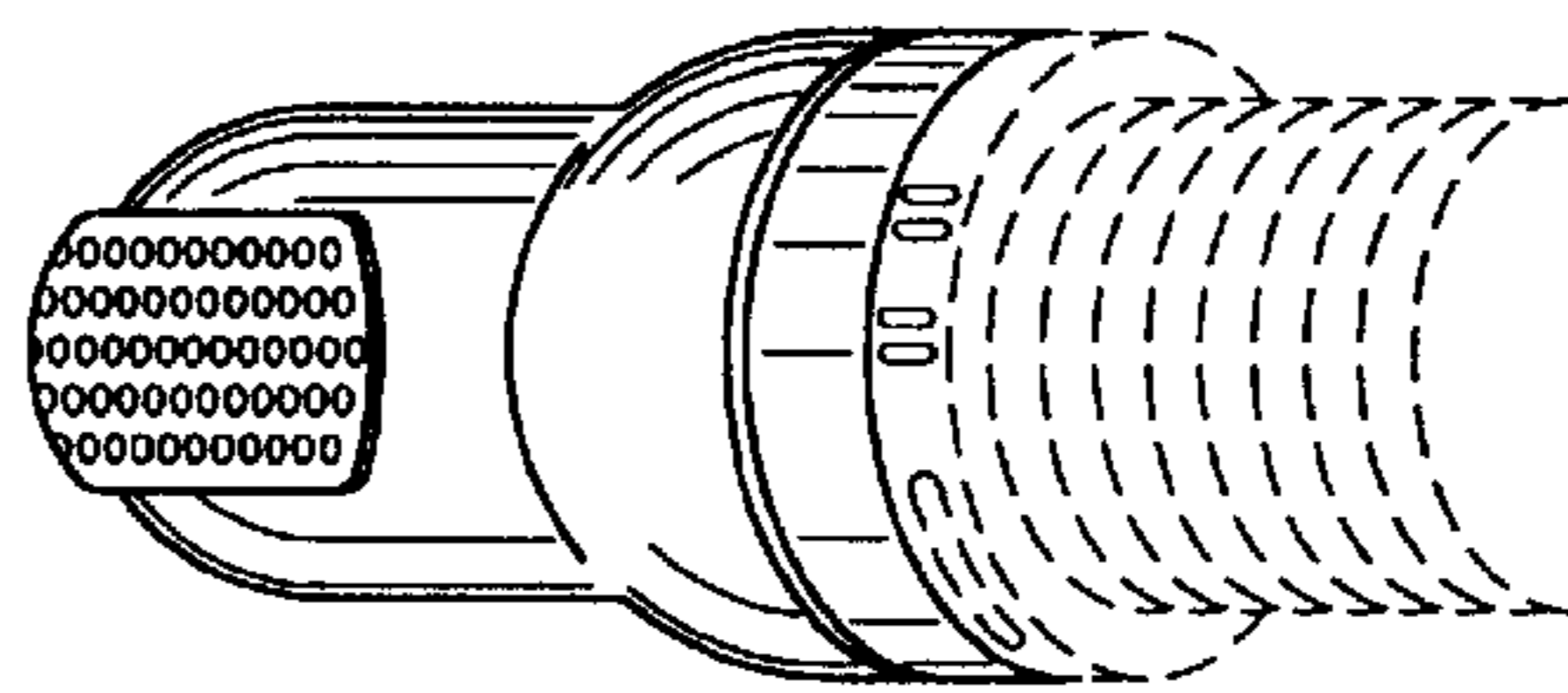

Fig. 6

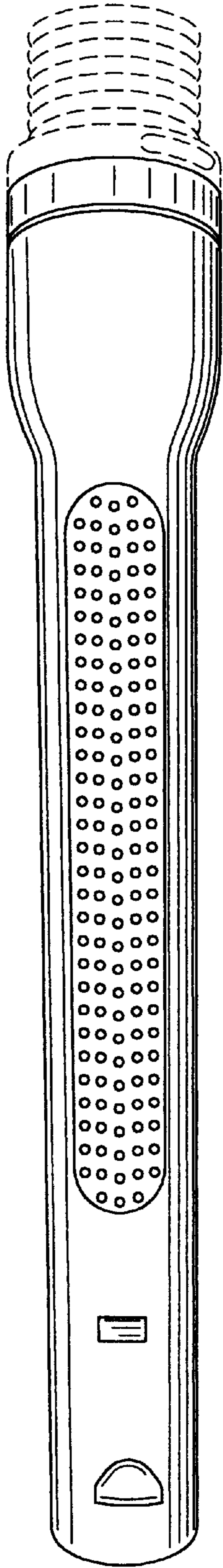

Fig. 7

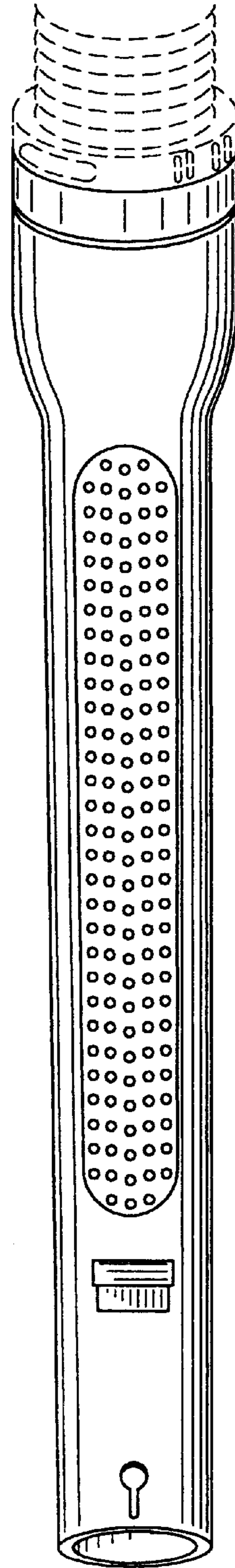

Fig. 8